

IDEAONE 2024

fami

.05



PELIZZARI
FAUSTINO
UTENSILI



INNOVATION
SINCE 1929.





CONSULENZA

Un particolare progetto che vorresti realizzare, una nuova area da allestire? I consulenti commerciali di Fami sono al tuo fianco per analizzare tutte le tue necessità e realizzare gli arredi ideali per la tua azienda.



GARANZIA

I 10 anni di garanzia dei prodotti Fami sono la diretta espressione dell'utilizzo di materiali di qualità, della cura e dedizione nella produzione per rendere i nostri arredi affidabili e durevoli nel tempo.



ORDINI

Ordinare i prodotti Fami Ideaone non è mai stato così facile! Scegli i diversi arredi e contatta il tuo agente di zona o rivenditore per completare il tuo ordine. Oppure visita Fami Shop per acquistare in pochi click!



GAMMA COLORI

Gli arredi Fami Ideaone presentano colorazioni standard, sia monocolore che bicolore, che variano a seconda del prodotto scelto. Su richiesta sono disponibili ulteriori tonalità per personalizzare ogni area di lavoro o adattare gli arredi ai colori aziendali.



VALIDITÀ

Il catalogo Fami Ideaone ha validità dal 01/04/2024 al 31/01/2025. I prezzi si ritengono validi durante tale periodo, salvo possibili variazioni, errori tipografici e/o omissioni di stampa.



FILIALI E RIVENDITORI

Fami è sempre accanto a te! Negli anni abbiamo sviluppato quattro filiali europee oltre a un'ampia rete di rivenditori e distributori, sia in Italia che all'estero, per fornirti consulenza e assistenza ovunque tu sia.



ASSISTENZA

Per qualsiasi domanda, informazione o problema il nostro servizio di assistenza post-vendita è sempre a tua disposizione. In caso di prodotti danneggiati o rotti riceverai sempre dei ricambi originali Fami in sostituzione.



SPEDIZIONE

Gli arredi industriali Fami Ideaone sono disponibili con consegna entro 20 giorni lavorativi. La spedizione è gratuita per ordini superiori a 250,00 € (isole escluse), mentre per importi minori il costo di gestione ordine è pari a 30,00 €.



VASCHE DI RACCOLTA + RIPIANI E VASCHE PERFORM IN ACCIAIO

Idonee a liquidi infiammabili delle categorie GHS 1 - 3 e liquidi inquinanti per le acque delle categorie GHS 1 - 4. Non sono ammesse sostanze corrosive.

VASCHE DI RACCOLTA IN PE

Idonee a liquidi inquinanti per le acque delle categorie GHS 1 - 4. Non sono ammesse sostanze infiammabili.

CONSEGNE PORTO FRANCO in tutta Italia (isole escluse) per ordini a partire da 250 €.
Per importi inferiori verrà applicato un contributo per costi di gestione di 30 €.

new

RK BOX AIR



ECOLOGIA



PICKING BOX AIR



BINCART



SYSTEM ST



SYSTEM ST



MORSE



indice

STOCCAGGIO

6

AIR

SERIE PRO+

- **PICKING BOX AIR** **6**
 - contenitori 10
 - armadi FAK 12
 - componenti 14

- **RK BOX AIR** **16**
 - contenitori 20
 - accessori 21
 - scaffali 24
 - componenti 26

CLASSIC

SERIE PRO

- **PICKING BOX** **28**
 - contenitori 30
 - accessori 32

- **RK BOX** **34**
 - contenitori
 - P= 300 mm 36
 - P= 400 mm 36
 - P= 500 mm 37
 - accessori 38

- scaffali
 - P= 300 mm 40
 - P= 400 mm 40
 - P= 500 mm 41
- componenti 42

- **EURO BOX** **44**
 - contenitori
 - 300x200 mm 46
 - 400x300 mm 46
 - 600x400 mm 48
 - 800x600 mm 51

- cassette divisorio
 - 400x300 mm 52
 - 600x400 mm 53
- accessori 54

- **EURO BOX ESD** **56**
 - contenitori
 - 400x300 mm 56
 - 600x400 mm 56
 - accessori 57

- **VISUAL BOX** **58**
 - cassettiere 60
 - componenti 61

- scaffali
 - H= 500 mm 62
 - H= 1000 mm 63
 - H= 1500 mm 64
 - H= 2000 mm 65

- scaffali con base
 - H= 1500 mm 66
 - H= 2000 mm 67

- **MAT** **68**
 - tappeti 69
 - componenti 69

STEEL

70

SERIE PRO+

- **STEEL** **70**
 - cassette e contenitori 71
 - contenitori fondo apribile 74
 - contenitori bocca di lupo 75

SCAFFALI

76

SERIE PRO

- **SYSTEM ST** **76**
 - scaffali con piani 80
 - componenti 81
 - scaffali portaminuterie 84
 - scaffali portapneumatici 86
 - scaffali a campata larga 87
 - scaffali con piani inclinati 88
 - scaffali Kanban 89
 - scaffali con contenitori 92

SERIE START

- **STORAGE DOMINO** **100**
 - scaffali 101



BANCHI DA LAVORO

104

SERIE START

- **WORK** **104**
- 1500x750 106
- 2000x750 110
- componenti 114
- materiale di separazione 120



SERIE PRO

- **WORK MASTER BR** **124**
- 1500x750 126
- 2000x750 130
- componenti 134
- materiale di separazione 142



SERIE PRO+

- **DYNAMIC** **146**
- preconfigurati 147
- componenti 150



PARETI ATTREZZATE

154

SERIE PRO

- **WORK LOOK** **154**
- preconfigurati 156
- componenti 158
- preconfigurati con pensili 159
- componenti 160
- preconfigurati con tapparelle 161
- pannelli forati 162
- componenti 164



• COMPONENTS **170**

- morse 171
- sedie 174
- tavolo pieghevole 175



• ERGO WORK **176**

- bracci per montanti 178
- bracci per piano 181
- componenti 184



• TOOL ORGANIZER **190**

- Unipok 191
- Pikpad 192
- The Block 195



• IRON TEAM **196**

- Iron Team 196
- Iron Team Electric 202
- Iron Team Light 204



ARMADI CON CASSETTI

206

SERIE START

- **FLEXA** **206**
- 36x27 EH 717x600 mm 208
- materiale di separazione 209
- 54x27 EH 1023x600 mm 210
- materiale di separazione 211



SERIE PRO

- **MASTER DE** **212**
- 36x36 EH 714x726 mm 216
- materiale di separazione 217
- 54x36 EH 1020x726 mm 218
- materiale di separazione 219
- accessori 220



SERIE PRO+

- **MASTER** **222**
- 18x27 EH 408x573 mm 228
- materiale di separazione 230
- 27x27 EH 561x573 mm 232
- materiale di separazione 236
- 36x27 EH 714x573 mm 238
- materiale di separazione 246
- 54x27 EH 1020x573 mm 248
- materiale di separazione 252
- 27x36 EH 561x726 mm 254
- materiale di separazione 262
- 36x36 EH 714x726 mm 264
- materiale di separazione 276
- 45x36 EH 867x726 mm 278
- materiale di separazione 280
- 54x36 EH 1020x726 mm 282
- materiale di separazione 288
- 64x36 EH 1190x726 mm 290
- materiale di separazione 292
- 78x36 EH 1428x726 mm 294
- materiale di separazione 296
- accessori 298



ARMADI PORTA COMPUTER

302

SERIE PRO+

- **MASTER CS** **304**
- preconfigurati 304
- componenti 305



SERIE PRO

- **STANDARD CS** **306**
- preconfigurati 306
- componenti 307



ARMADI CON PORTE

308

SERIE PRO

- **PERFOM**
PORTE A BATTENTE **308**
 - 64x27 EH 1193x555x1000 mm 309
 - 64x27 EH 1193x555x2000 mm 310
 - 24x27 EH 512x555x1000 mm 311
 - 54x27 EH 1023x555x1000 mm 312
 - 54x27 EH 1023x555x2000 mm 314
 - componenti 322
 - materiale di separazione 334
- **PERFOM**
PORTE SCORREVOLI **336**
 - 54x27 EH 1020x600x2000 mm 338
 - 54x27 EH 1020x600x915 mm 339
 - 78x27 EH 1428x600x2000 mm 340
 - 78x27 EH 1428x600x915 mm 341
 - 54+54x27 EH 2040x600x2000 mm 342
 - 54+54x27 EH 2040x600x915 mm 344
 - componenti 345
 - materiale di separazione 353
- **PERFOM**
SPOGLIATOIO **354**
 - preconfigurati 355
 - panchine 356
 - preconfigurati 357

NC

360

SERIE PRO

- **NC** **360**
 - preconfigurati 361
 - componenti 362

ECOLOGIA

364

SERIE PRO

- **BENNE** **365**
- **PORTA BIG BAG** **367**
- **VASCHE DI RACCOLTA** **368**
- **ARMADI DI SICUREZZA** **375**

CARRELLI

378

SERIE PRO

- **CLEVER** **378**
 - Clever Small preconfigurati 379
 - Clever Large preconfigurati 380
 - componenti 386
- **COMBI** **389**

SERIE PRO+

- **BIN CART** **390**
 - preconfigurati 391
 - componenti 404

ARREDO OFFICINA

410

GEAR GARAGE

- **BEST SELLER** **418**
- **MODULI** **430**
 - L= 714 mm 430
 - L= 1020 mm 431
 - L= 1428 mm 432
 - L= 1734 mm 433
 - L= 2040 mm 434
 - corner 436
 - Flexa 436
- **PERFOM**
PORTE BATTENTI **437**
 - L= 512 mm 437
 - L= 1023 mm 437
- **PERFOM**
PORTE SCORREVOLI **438**
 - L= 1020 mm 438
 - L= 1427 mm 438
 - L= 2040 mm 439
 - accessori 439
 - materiale di separazione 440

- **CONDIZIONI**
GENERALI DI GARANZIA **445**

- **CONDIZIONI**
GENERALI DI VENDITA **446**

AIR PICKING BOX

CONTENITORI IN PLASTICA
SERIE PRO+



Air è la gamma di contenitori in plastica ideata da Fami. Funzionali e di design, questi contenitori sono studiati per ottimizzare gli spazi e l'organizzazione di postazioni di lavoro, magazzini e nel trasporto.

I contenitori **Picking Box Air** sono una soluzione **salvaspazio** per la custodia di componenti e C-Parts, caratterizzati da una particolare **struttura** ideata per poterli stoccare sia **sovrapposti** che **inseriti** l'uno dentro l'altro e per essere **compatibili** con contenitori a bocca di lupo di altri brand. Ogni elemento del contenitore ha una precisa funzione: le **nervature** laterali e il **fondo** rinforzato **irrobustiscono** la struttura e **distribuiscono** uniformemente il carico; gli **inserti brevettati** garantiscono una **sovrapposizione stabile** e sicura; l'ampia **apertura frontale** massimizza la **visibilità** del contenuto e l'**ergonomia** nel prelievo del materiale; il **gancio posteriore** consente il posizionamento di Picking Box Air su profili di carrelli Bin Cart e barre Iron Team.

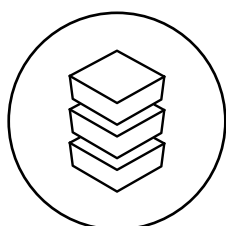

SOVRAPPONIBILE
E COMPATIBILE

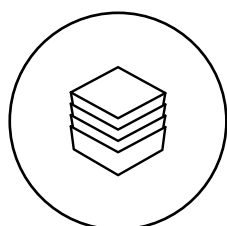

INSERIBILE

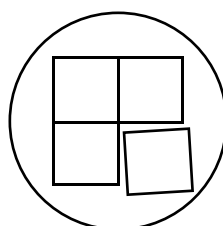

INTEGRABILE



ECOSOSTENIBILE



PICKING BOX AIR

I contenitori sono caratterizzati da:

1. Maniglia
2. Inserti per sovrapposizione
3. Rinforzo strutturale
4. Forma conica per agevolare l'inserimento dei contenitori uno dentro l'altro
5. Gancio posteriore per l'aggancio su barre (mis. 1, 2, 3A2, 3)
Maniglia posteriore per il trasporto (mis. 4, 4A5)

Disponibili in 6 colori:



SISTEMA DI SOVRAPPOSIZIONE BREVETTATO

Gli inserti brevettati garantiscono una sovrapposizione salda e sicura dei diversi Picking Box Air e distribuiscono uniformemente il peso.



SOVRAPPONIBILI E INSERIBILI

I contenitori Picking Box Air possono passare dalla sovrapposizione all'inserimento uno dentro l'altro con un semplice movimento della mano.



6 DIMENSIONI

Picking Box Air è disponibile in 6 misure con differenti capacità di stoccaggio.

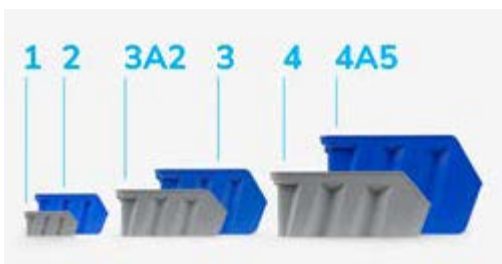

FONDO RINFORZATO

Il fondo è dotato di particolari nervature per aumentarne la robustezza e dissipare i pesi.



APERTURA FRONTALE

L'apertura frontale è più ampia ed ergonomica per aumentare la visibilità e facilitare il prelievo del contenuto in caso di sovrapposizione.



ETICHETTE

Le etichette adesive possono essere posizionate nello spazio frontale per facilitare la classificazione del contenuto.



COMPATIBILITÀ

La conformazione dei bordi superiori è ideata per garantire la sovrapposizione di contenitori di altri brand.



GANCIO POSTERIORE

I contenitori di mis. 1, 2, 3A2 e 3 sono dotati di un gancio posteriore che aumenta la stabilità del contenitore quando è installato sui profili dei carrelli Bin Cart o sulle barre Iron Team. I Picking Box Air di misura 4 e 4A5, invece, presentano una maniglia per agevolarne la movimentazione manuale.



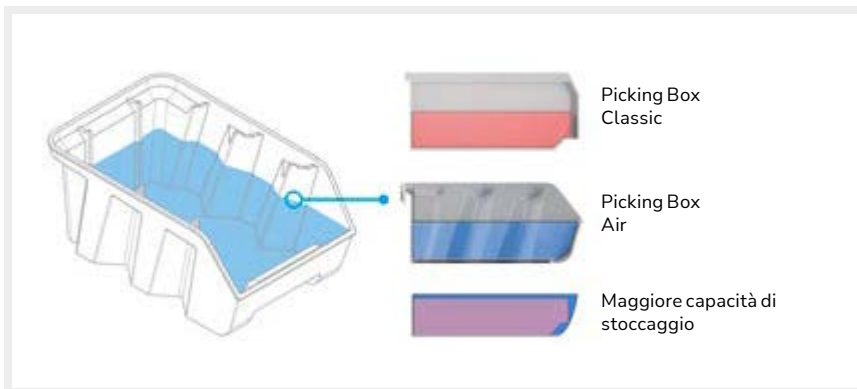

PIÙ SPAZIO ED ERGONOMIA

I contenitori Picking Box Air rappresentano l'evoluzione dei tradizionali contenitori a bocca di lupo presenti in commercio.

Rispetto ai Picking Box Classic, Air è caratterizzato da una maggiore apertura anteriore che rende più ergonomico il prelievo del materiale stoccato e migliora la visibilità.

La particolare conformazione delle pareti laterali delle Picking Box Air non ostacola la visione e non riduce lo spazio interno del contenitore. La capacità di stoccaggio della linea Air, infatti, è maggiore rispetto a quella delle Classic: l'ingombro strutturale delle pareti è distribuito in modo tale da creare nuove aree che compensano ampiamente gli spazi occupati dalle nervature.



Confronto spazio interno di stoccaggio:



TRASPORTO OTTIMIZZATO ED EFFICIENTE



La gamma Picking Box Air consente un risparmio del 50% degli spazi in magazzino e nel trasporto. L'innestabilità e la compatibilità con gli Europallet dei contenitori, infatti, rendono le diverse operazioni interne e logistiche più efficienti e sempre più ottimizzate determinando una riduzione in termini di consumi aziendali e di impatto ambientale. In particolare, un'analisi ha rivelato come l'utilizzo delle Picking Box Air comporti una diminuzione dei consumi da costi di magazzinaggio (-57%) e da movimentazione interna (-27%), oltre ad una minor emissione di CO2 della catena logistica (-10 tonnellate)*.

** Analisi condotta simulando l'utilizzo di Picking Box Air per un anno nell'attività aziendale Fami. Il confronto è stato svolto comparando la totalità delle attività ed i relativi consumi del 2023 dei contenitori tradizionali Picking Box con la medesima quantità di attività ricalcolata sui consumi necessari a stoccaggio e movimentazione degli Picking Box Air.*

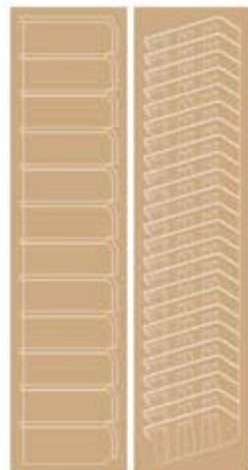



1



CONTENITORE CON FONDO RINFORZATO

ART.	multiplo d'ordine	mis.	dim.ingombro			L	colore	€
			Lmm	P mm	H mm			
FPB0001R051LQ	48	1	108	173	76	1		1,20
FPB0001R05139	48	1	108	173	76	1		1,20
FPB0001R05132	48	1	108	173	76	1		1,20
FPB0001R0511Z	48	1	108	173	76	1		1,20
FPB0001R0512Y	48	1	108	173	76	1		1,20
FPB0001R0514Q	48	1	108	173	76	1		1,20



2



CONTENITORE CON FONDO RINFORZATO

ART.	multiplo d'ordine	mis.	dim.ingombro			L	colore	€
			Lmm	P mm	H mm			
FPB0002R051LQ	36	2	160	234	127	3,8		2,10
FPB0002R05139	36	2	160	234	127	3,8		2,10
FPB0002R05132	36	2	160	234	127	3,8		2,10
FPB0002R0511Z	36	2	160	234	127	3,8		2,10
FPB0002R0512Y	36	2	160	234	127	3,8		2,10
FPB0002R0514Q	36	2	160	234	127	3,8		2,10



3A2



CONTENITORE CON FONDO RINFORZATO

ART.	multiplo d'ordine	mis.	dim.ingombro			L	colore	€
			Lmm	P mm	H mm			
FPB03A2R051LQ	16	3A2	224	354	147	9,4		4,80
FPB03A2R05139	16	3A2	224	354	147	9,4		4,80
FPB03A2R05132	16	3A2	224	354	147	9,4		4,80
FPB03A2R0511Z	16	3A2	224	354	147	9,4		4,80
FPB03A2R0512Y	16	3A2	224	354	147	9,4		4,80
FPB03A2R0514Q	16	3A2	224	354	147	9,4		4,80



3



CONTENITORE CON FONDO RINFORZATO

ART.	multiplo d'ordine	mis.	dim.ingombro			L	colore	€
			Lmm	P mm	H mm			
FPB0003R051LQ	12	3	224	354	203	12,5		4,80
FPB0003R05139	12	3	224	354	203	12,5		4,80
FPB0003R05132	12	3	224	354	203	12,5		4,80
FPB0003R0511Z	12	3	224	354	203	12,5		4,80
FPB0003R0512Y	12	3	224	354	203	12,5		4,80
FPB0003R0514Q	12	3	224	354	203	12,5		4,80

CONTENITORE CON FONDO RINFORZATO

4

ART.	multiplo d'ordine	mis.	dim. ingombro			L	colore	€
			L mm	P mm	H mm			
FPB0004R051LQ	12	4	333	508	203	28		8,40
FPB0004R05139	12	4	333	508	203	28		8,40
FPB0004R05132	12	4	333	508	203	28		8,40
FPB0004R0511Z	12	4	333	508	203	28		8,40
FPB0004R0512Y	12	4	333	508	203	28		8,40
FPB0004R0514Q	12	4	333	508	203	28		8,40

CONTENITORE CON FONDO RINFORZATO

4A5

ART.	multiplo d'ordine	mis.	dim. ingombro			L	colore	€
			L mm	P mm	H mm			
FPB04A5R051LQ	9	4A5	333	507	304	42		11,10
FPB04A5R05139	9	4A5	333	507	304	42		11,10
FPB04A5R05132	9	4A5	333	507	304	42		11,10
FPB04A5R0511Z	9	4A5	333	507	304	42		11,10
FPB04A5R0512Y	9	4A5	333	507	304	42		11,10
FPB04A5R0514Q	9	4A5	333	507	304	42		11,10



ARMADI CON PORTE A BATTENTE



ARMADIO CON PORTE A BATTENTE CON 24 CONTENITORI PICKING BOX AIR

ART.	L mm	P mm	H mm	KG	colore contenitori	RAL	€
PERFOMAK03	700	267	1001	450		7035+7016	356,70
PERFOMAK04	700	267	1001	450		7035	356,70
PERFOMAK05	700	267	1001	450		5012	356,70

Composto da:

qtà	descrizione
1	Armadio con porte a battente
1	Kit 5 piani regolabili
8	Kit 3 contenitori Picking Box Air mis. 2



ARMADIO CON PORTE A BATTENTE CON 48 CONTENITORI PICKING BOX AIR

ART.	L mm	P mm	H mm	KG	colore contenitori	RAL	€
PERFOMAK08	700	267	1651	500		7035+7016	449,40
PERFOMAK09	700	267	1651	500		7035	449,40
PERFOMAK10	700	267	1651	500		5012	449,40

Composto da:

qtà	descrizione
1	Armadio con porte a battente
2	Kit 5 piani regolabili
36	Contenitore in polipropilene Picking Box Air mis. 2
3	Kit 4 contenitori Picking Box Air mis. 1
2	Fermo per contenitori mis. 1



ARMADIO CON PORTE A BATTENTE CON 72 CONTENITORI PICKING BOX AIR

ART.	L mm	P mm	H mm	KG	colore contenitori	RAL	€
PERFOMAK13	700	267	1996	500		7035+7016	545,10
PERFOMAK14	700	267	1996	500		7035	545,10
PERFOMAK15	700	267	1996	500		5012	545,10

Composto da:

qtà	descrizione
1	Armadio con porte a battente
1	Kit 5 piani regolabili
3	Kit 3 piani regolabili
36	Contenitore in polipropilene Picking Box Air mis. 2
9	Kit 4 contenitori Picking Box Air mis. 1
6	Fermo per contenitori mis. 1

ARMADI SENZA PORTE A BATTENTE



ARMADIO CON 24 CONTENITORI PICKING BOX AIR

ART.	L mm	P mm	H mm	KG	colore contenitori	RAL	€
PERFOMAK01	700	267	1001	450		7035	261,30
PERFOMAK02	700	267	1001	450		5012	261,30

Composto da:

qtà	descrizione
1	Armadio senza porte a battente
1	Kit 5 piani regolabili
8	Kit 3 contenitori Picking Box Air mis. 2



ARMADIO CON 48 CONTENITORI PICKING BOX AIR

ART.	L mm	P mm	H mm	KG	colore contenitori	RAL	€
PERFOMAK06	700	267	1651	500		7035	340,80
PERFOMAK07	700	267	1651	500		5012	340,80

Composto da:

qtà	descrizione
1	Armadio senza porte a battente
2	Kit 5 piani regolabili
36	Contenitore in polipropilene Picking Box Air mis. 2
3	Kit 4 contenitori Picking Box Air mis. 1
2	Fermo per contenitori mis. 1



ARMADIO CON 72 CONTENITORI PICKING BOX AIR

ART.	L mm	P mm	H mm	KG	colore contenitori	RAL	€
PERFOMAK11	700	267	1996	500		7035	427,50
PERFOMAK12	700	267	1996	500		5012	427,50

Composto da:

qtà	descrizione
1	Armadio senza porte a battente
1	Kit 5 piani regolabili
3	Kit 3 piani regolabili
36	Contenitore in polipropilene Picking Box Air mis. 2
9	Kit 4 contenitori Picking Box Air mis. 1
6	Fermo per contenitori mis. 1



PORTATA



RAL 7035 + RAL 7016



RAL 5012





RAL 7035

COMPONENTI



ARMADIO CON PORTE A BATTENTE

ART.	L mm	P mm	H mm	KG	RAL	€
 FAK1040C000PD	700	267	1001	450	7035+7016	252,00
 FAK1040C00008	700	267	1001	450	7035	252,00
 FAK1040C00004	700	267	1001	450	5012	252,00



ARMADIO CON PORTE A BATTENTE

ART.	L mm	P mm	H mm	KG	RAL	€
 FAK1066C000PD	700	267	1651	500	7035+7016	274,50
 FAK1066C00008	700	267	1651	500	7035	274,50
 FAK1066C00004	700	267	1651	500	5012	274,50





ARMADIO CON PORTE A BATTENTE

ART.	L mm	P mm	H mm	KG	RAL	€
 FAK1080C000PD	700	267	1996	500	7035+7016	299,10
 FAK1080C00008	700	267	1996	500	7035	299,10
 FAK1080C00004	700	267	1996	500	5012	299,10





COMPONENTI



ARMADIO SENZA PORTE A BATTENTE

ART.	L mm	P mm	H mm		RAL	€
 FAK2040X00008	700	267	1001	450	7035	156,60
 FAK2040X00004	700	267	1001	450	5012	156,60





ARMADIO SENZA PORTE A BATTENTE

ART.	L mm	P mm	H mm		RAL	€
 FAK2066X00008	700	267	1651	500	7035	165,90
 FAK2066X00004	700	267	1651	500	5012	165,90



ARMADIO SENZA PORTE A BATTENTE

ART.	L mm	P mm	H mm		RAL	€
 FAK2080X00008	700	267	1996	500	7035	181,50
 FAK2080X00004	700	267	1996	500	5012	181,50

KIT PIANI REGOLABILI

ART.	L mm	P mm	H mm	n. piani		finitura	€
 FAK9020S299	675	235	17	3	50	Zincato	24,00
 FAK9020S199	675	235	17	5	50	Zincato	39,90

FERMO PER CONTENITORI MIS. 1

ART.	L mm	P mm	H mm	finitura	€
 FAK90400099	671	31	11	Zincato	1,20



PORTATA



RAL 7035 + RAL 7016



RAL 5012



RAL 7035



ZINCATO

AIR RK BOX

CONTENITORI IN PLASTICA
SERIE PRO+



AIR

Air è la gamma di contenitori in plastica ideata da Fami. Funzionali e di design, questi contenitori sono studiati per ottimizzare gli spazi e l'organizzazione di postazioni di lavoro, magazzini e nel trasporto.

I contenitori per scaffali RK Box Air sono delle innovative soluzioni per la **custodia** e lo **stoccaggio** di una vasta gamma di componenti. Il particolare design è stato progettato per poter **sovrapporre** in totale sicurezza i diversi contenitori e per poterli **inserire uno dentro l'altro**, comportando un notevole **risparmio di spazio**. L'ampia apertura frontale facilita il prelievo del materiale, mentre il **fondo rinforzato** presenta un'apposita scanalatura centrale che, utilizzata in combinazione con la guida per scaffali, trasforma il contenitore in un vero e proprio **cassetto** con blocco in apertura e chiusura.

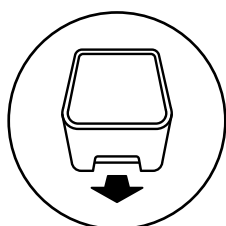

ESTRAIBILE

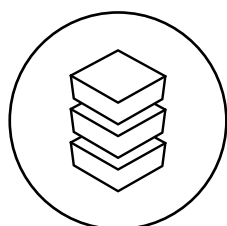

SOVRAPPONIBILE

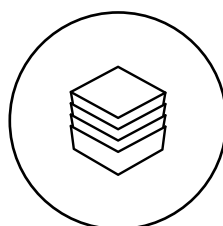

INSERIBILE

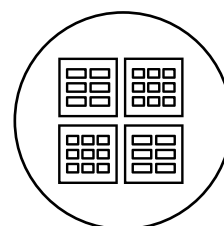

MODULARE



RK BOX AIR

I contenitori per scaffali sono caratterizzati da:

1. Bordi rinforzati
2. Maniglia
3. Inserti per sovrapposizione
4. Forma conica per agevolare l'inserimento dei contenitori uno dentro l'altro
5. Rinforzo strutturale per l'installazione dei divisori trasversali
6. Gancio per coperchio
7. Predisposizione per frontalino

Disponibili in 2 colori:



SISTEMA DI SOVRAPPOSIZIONE BREVETTATO

Gli inserti brevettati garantiscono una sovrapposizione salda e sicura dei diversi RK Box Air e distribuiscono uniformemente il peso.



SOVRAPPONIBILI E INSERIBILI

I contenitori RK Box Air possono passare dalla sovrapposizione all'inserimento uno dentro l'altro con un semplice movimento della mano.

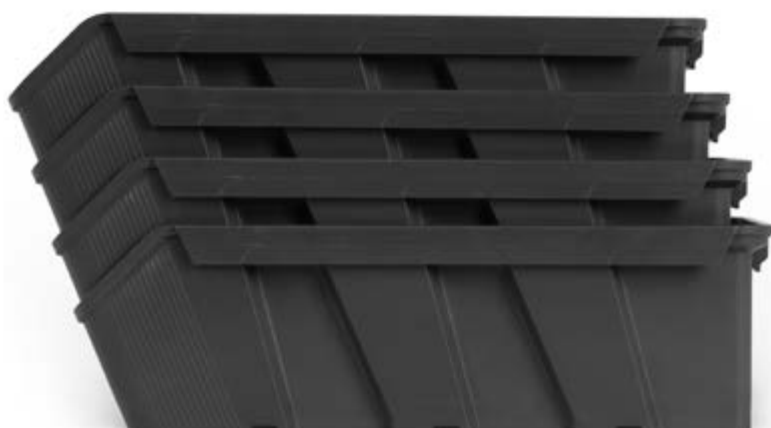

BORDI E FONDO RINFORZATI

Bordi e fondo rinforzati evitano la deformazione e irrobustiscono la struttura degli RK Box Air per il contenimento di carichi pesanti.

**4 DIMENSIONI**

I contenitori sono disponibili in due altezze e due larghezze.

**ETICHETTE**

Le etichette adesive possono essere posizionate nello spazio frontale per facilitare la classificazione del contenuto.

**ACCESSORI**

RK Box Air può essere completato con una vasta gamma di accessori come frontalini, coperchi e divisori trasversali.

VISIBILITÀ MASSIMA

Gli accessori per la suddivisione e la protezione del contenuto sono realizzati in polistirolo trasparente per garantire la massima visibilità e l'immediata identificazione dei materiali stoccati.

FRONTALINO

Il frontalino trasparente chiude l'apertura frontale degli RK Box Air senza impedire la visione del contenuto. Il particolare design si adatta perfettamente alla forma del contenitore, inserendosi con un clic. Può essere utilizzato in combinazione con il coperchio per chiudere completamente il contenitore.

**DIVISORIO**

Il divisorio trasversale suddivide lo spazio interno degli RK Box Air in più scomparti per lo stoccaggio di componenti di natura diversa. È trasparente per consentire la visione di tutto il materiale e si incastra perfettamente nei rinforzi laterali senza occupare spazio.

**COPERCHIO**

Il coperchio per RK Box Air è installato ad incastro sulla parte superiore del contenitore e presenta un'apertura parziale o totale. La trasparenza rende sempre visibile il materiale stoccato e può essere utilizzato in combinazione con il frontalino per la protezione completa del contenuto degli RK Box Air.



SCAFFALI MODULARI PER CONTENITORI

Lo scaffale per contenitori presenta un numero variabile di ripiani su cui organizzare in ordine e in completa sicurezza gli RK Box Air.

Ogni ripiano è dotato di una guida che si incastra perfettamente nella scanalatura presente sul fondo del contenitore e che rende RK Box Air un pratico e sicuro cassetto, dotato di blocco in apertura e chiusura. A differenza dei tradizionali scaffali per RK Box, quindi, non è necessario installare fermi posteriori in quanto una volta estratto il contenitore questo si bloccherà senza cadere. In qualsiasi momento è possibile ampliare la scaffalatura: basterà, infatti, impilare i diversi scaffali tramite le pratiche alette poste nella parte superiore.





CONTENITORE CON FONDO RINFORZATO - DIM. INGOMBRO (mm): L=141 P=310 H=91

ART.	multiplo d'ordine	dim. utili			L	colore	€
		L mm	P mm	H mm			
FRK3014R05139	20	102	248	79	2,4		4,20
FRK3014R05132	20	102	248	79	2,4		4,20



CONTENITORE CON FONDO RINFORZATO - DIM. INGOMBRO (mm): L=214 P=310 H=91

ART.	multiplo d'ordine	dim. utili			L	colore	€
		L mm	P mm	H mm			
FRK3021R05139	20	176	245	79	4		4,80
FRK3021R05132	20	176	245	79	4		4,80



CONTENITORE CON FONDO RINFORZATO - DIM. INGOMBRO (mm): L=141 P=310 H=142

ART.	multiplo d'ordine	dim. utili			L	colore	€
		L mm	P mm	H mm			
FRK3114R05139	16	100	234	130	3,8		5,10
FRK3114R05132	16	100	234	130	3,8		5,10







CONTENITORE CON FONDO RINFORZATO - DIM. INGOMBRO (mm): L=214 P=310 H=142

ART.	multiplo d'ordine	dim. utili			L	colore	€
		L mm	P mm	H mm			
FRK3121R05139	16	174	234	130	6,5		5,70
FRK3121R05132	16	174	234	130	6,5		5,70



ACCESSORI

DIVISORIO TRASVERSALE PER CONTENITORE RK BOX AIR





ART.	multiplo d'ordine	adatto per	€
 FRKD014T00096	20	FRK3014R051	1,20
 FRKD021T00096	20	FRK3021R051	1,80
 FRKD114T00096	16	FRK3114R051	2,10
 FRKD121T00096	16	FRK3121R051	2,70



Il divisorio trasversale si inserisce perfettamente nei rinforzi del contenitore per creare più aree di stoccaggio senza occupare spazio.



FRONTALINO PER CONTENITORE RK BOX AIR

ART.	multiplo d'ordine	adatto per	€
 FRKF014000096	20	FRK3014R051	1,50
 FRKF021000096	20	FRK3021R051	1,80
 FRKF114000096	16	FRK3114R051	2,40
 FRKF121000096	16	FRK3121R051	3,00



Il frontalino è sagomato per adattarsi alla forma della parte frontale del contenitore.



COPERCHIO PER CONTENITORE RK BOX AIR

ART.	multiplo d'ordine	adatto per	€
 FRK3C14000096	20	FRK3014R051 FRK3114R051	5,40
 FRK3C21000096	20	FRK3021R051 FRK3121R051	7,20





Il coperchio si installa ad incastro sui bordi superiori del contenitore e ha un'apertura parziale o totale.

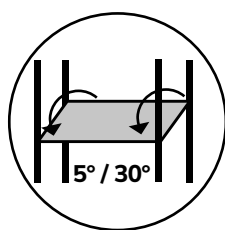



SCAFFALE CON 7 PIANI INCLINATI

ART.	L mm	P mm	H mm	n. kit 4 separatori	finitura	€
 ST1036	1057	521	2016	10	Zincato	654,30
 ST1037	1057	621	2016	10	Zincato	762,30
 ST1038	1057	821	2016	10	Zincato	821,10

Completo di bordi fermacasse e coppia staffe per piani inclinati 5°/30°

 Piani con profondità 500 mm portata 120 kg. Piani con profondità 600 e 800 mm portata 300 kg.





P= 300 mm



SCAFFALE CON 9 CONTENITORI RK BOX AIR

ART.	L mm	P mm	H mm	contenitori		RAL	€
				n.	colore		
RKBOX3051	496	304	546	6 x FRK3114R05139 3 x FRK3121R05139		7035	151,50
RKBOX3050	496	304	546	6 x FRK3114R05132 3 x FRK3121R05132		7000	151,50

Composto da:

qtà	descrizione
1	Scaffale a 4 piani
1	Kit 9 contenitori RK Box Air



SCAFFALE CON 9 CONTENITORI RK BOX AIR CON GUIDE DIVISORI E FRONTALINI

ART.	L mm	P mm	H mm	contenitori		RAL	€
				n.	colore		
RKBOX3053	496	304	546	6 x FRK3114R05139 3 x FRK3121R05139		7035	228,60
RKBOX3052	496	304	546	6 x FRK3114R05132 3 x FRK3121R05132		7000	228,60

Composto da:

qtà	descrizione
1	Scaffale a 4 piani
1	Kit 9 contenitori RK Box Air
1	Kit 9 guide con divisori e frontalini



SCAFFALE CON 9 CONTENITORI RK BOX AIR CON GUIDE COPERCHI E FRONTALINI

ART.	L mm	P mm	H mm	contenitori		RAL	€
				n.	colore		
RKBOX3055	496	304	546	6 x FRK3114R05139 3 x FRK3121R05139		7035	255,90
RKBOX3054	496	304	546	6 x FRK3114R05132 3 x FRK3121R05132		7000	255,90

Composto da:

qtà	descrizione
1	Scaffale a 4 piani
1	Kit 9 contenitori RK Box Air
1	Kit 9 guide con coperchi e frontalini



RK Box Air non necessita di fermi quando è inserito negli scaffali. La guida installata e la sagomatura del fondo del contenitore stesso permettono di utilizzare RK Box Air come un cassetto grazie al particolare meccanismo di blocco in apertura e chiusura.



P= 300 mm



SCAFFALE CON 12 CONTENITORI RK BOX AIR

ART.	L mm	P mm	H mm	contenitori		RAL	€
				n.	colore		
RKBOX3057	496	304	546	8 x FRK3014R05139 4 x FRK3021R05139		7035	164,10
RKBOX3056	496	304	546	8 x FRK3014R05132 4 x FRK3021R05132		7000	164,10

Composto da:

qtà	descrizione
1	Scaffale a 5 piani
1	Kit 12 contenitori RK Box Air



SCAFFALE CON 12 CONTENITORI RK BOX AIR CON GUIDE DIVISORI E FRONTALINI

ART.	L mm	P mm	H mm	contenitori		RAL	€
				n.	colore		
RKBOX3059	496	304	546	8 x FRK3014R05139 4 x FRK3021R05139		7035	241,20
RKBOX3058	496	304	546	8 x FRK3014R05132 4 x FRK3021R05132		7000	241,20

Composto da:

qtà	descrizione
1	Scaffale a 5 piani
1	Kit 12 contenitori RK Box Air
1	Kit 12 guide con divisori e frontalini



SCAFFALE CON 12 CONTENITORI RK BOX AIR CON GUIDE COPERCHI E FRONTALINI

ART.	L mm	P mm	H mm	contenitori		RAL	€
				n.	colore		
RKBOX3061	496	304	546	8 x FRK3014R05139 4 x FRK3021R05139		7035	281,10
RKBOX3060	496	304	546	8 x FRK3014R05132 4 x FRK3021R05132		7000	281,10

Composto da:

qtà	descrizione
1	Scaffale a 5 piani
1	Kit 12 contenitori RK Box Air
1	Kit 12 guide con coperchi e frontalini



RAL 7000 RAL 7035

COMPONENTI PER SCAFFALI PER RK BOX AIR



SCAFFALE VUOTO

ART.	L mm	P mm	H mm	n. ripiani	RAL	€
FRK BX30040008	496	304	546	4	7035	90,00
FRK BX30040001	496	304	546	4	7000	90,00
FRK BX30050008	496	304	546	5	7035	99,90
FRK BX30050001	496	304	546	5	7000	99,90



KIT 9 CONTENITORI RK BOX AIR

ART.	adatto per	contenitori		€
		n.	colore	
FRK BX30KB0139	FRK BX300400	6 x FRK3114R05139 3 x FRK3121R05139		61,50
FRK BX30KB0132	FRK BX300400	6 x FRK3114R05132 3 x FRK3121R05132		61,50



KIT 12 CONTENITORI RK BOX AIR

ART.	adatto per	contenitori		€
		n.	colore	
FRK BX30KB0239	FRK BX300500	8 x FRK3014R05139 4 x FRK3021R05139		64,20
FRK BX30KB0232	FRK BX300500	8 x FRK3014R05132 4 x FRK3021R05132		64,20



KIT 9 GUIDE CON DIVISORI E FRONTALINI

ART.	adatto per	€
FRK BX30KD0100	FRK BX300400	77,10

Questo kit è composto da 9 guide per l'installazione di RK Box Air su scaffale, 9 divisori e 9 frontalini per contenitore.

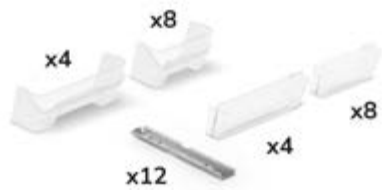

KIT 12 GUIDE CON DIVISORI E FRONTALINI

ART.	adatto per	€
FRK BX30KD0200	FRK BX300500	77,10

Questo kit è composto da 12 guide per l'installazione di RK Box Air su scaffale, 12 divisori e 12 frontalini per contenitore.



KIT 9 GUIDE CON COPERCHI E FRONTALINI

ART.	adatto per	€
FRK BX30KC0100	FRK BX300400	104,40

Questo kit è composto da 9 guide per l'installazione di RK Box Air su scaffale, 9 coperchi e 9 frontalini per contenitore.



KIT 12 GUIDE CON COPERCHI E FRONTALINI

ART.	adatto per	€
FRK BX30KC0200	FRK BX300500	117,00

Questo kit è composto da 12 guide per l'installazione di RK Box Air su scaffale, 12 coperchi e 12 frontalini per contenitore.



La struttura modulare consente di impilare scaffali con la medesima profondità o con profondità decrescente.

Ogni scaffale, infatti, presenta delle alette nella parte superiore per sovrapporre in modo stabile e sicuro i diversi moduli.



 RAL 7000

 RAL 7035

CLASSIC PICKING BOX

CONTENITORI IN PLASTICA
SERIE PRO



I **contenitori a bocca di lupo Picking Box** sono le soluzioni professionali per la gestione e la raccolta di piccoli componenti, ricambi e minuteria. Sono caratterizzati da un'**apertura frontale** che agevola la visione e il prelievo del materiale contenuto e sono dotati di **bordi rinforzati** per poterli impilare in tutta sicurezza.

Picking Box può essere arricchito con una vasta gamma di accessori, sia per la suddivisione dello spazio interno che per la protezione e l'identificazione del contenuto. Oltre ai tradizionali divisori, infatti, sono disponibili frontalini, parapolvere, coperchi ed etichette.

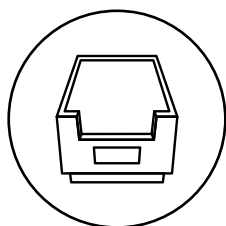

**APERTURA
FRONTALE BOCCA
DI LUPO**

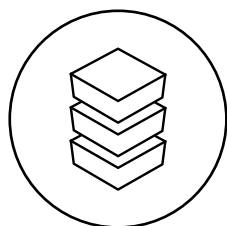

SOVRAPPONIBILE

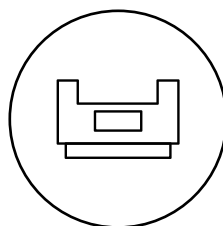

**ETICHETTE DI
SERIE**

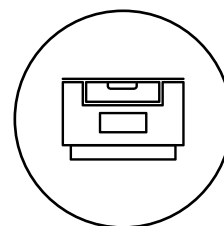

**AMPIA GAMMA
ACCESSORI**

CLASSIC



PICKING BOX

I diversi modelli di contenitori a bocca di lupo sono caratterizzati da:

1. Guide di sospensione con bordi rinforzati
2. Angoli anteriori smussati
3. Portaetichette con etichette di serie
4. Predisposizione per divisorio longitudinale
5. Innesti per accessori

Disponibili in 4 colori:



BORDI RINFORZATI

I bordi rinforzati rendono la struttura del contenitore più robusta e facilitano la distribuzione del peso in caso di sovrapposizione, evitandone la deformazione.

MANIGLIE

Maniglie frontali e posteriori sono ergonomiche per agevolare la presa e la movimentazione di Picking Box all'interno dell'area di lavoro.

FONDO

I contenitori a bocca di lupo sono disponibili con fondo liscio o fondo rinforzato per una capacità di carico più elevata.



SOVRAPPONIBILI E COMPATIBILI

La particolare conformazione della parte superiore e inferiore del contenitore a bocca di lupo permette la **sovrapposizione stabile e sicura** dei Picking Box anche di diverse misure e in presenza di coperchi e parapolveri. In caso di sovrapposizione, l'accesso al materiale contenuto è comunque possibile grazie all'apertura frontale.

I Picking Box Classic, inoltre, sono **compatibili** con i contenitori a bocca di lupo di **altri brand**.

SUDDIVISIONE E PROTEZIONE

Frontalino



Parapolvere



Coperchio



Divisorio longitudinale

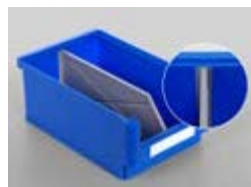

Traversino



CONTENITORE CON FONDO LISCIO - DIM. INGOMBRO (mm): L=103 P=160 H=75

ART.	multiplo d'ordine	mis.	dim. utili			L	colore	€
			L mm	P mm	H mm			
FAXPB0001L0513Z	40	1	85	136	68	0,8		1,20
FAXPB0001L0511Z	40	1	85	136	68	0,8		1,20
FAXPB0001L0512Y	40	1	85	136	68	0,8		1,20
FAXPB0001L0515S	40	1	85	136	68	0,8		1,20

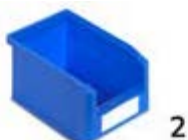
CONTENITORE CON FONDO LISCIO - DIM. INGOMBRO (mm): L=150 P=230 H=125

ART.	multiplo d'ordine	mis.	dim. utili			L	colore	€
			L mm	P mm	H mm			
FAXPB0002L0513Z	20	2	127	196	116	3		2,40
FAXPB0002L0511Z	20	2	127	196	116	3		2,40
FAXPB0002L0512Y	20	2	127	196	116	3		2,40
FAXPB0002L0515S	20	2	127	196	116	3		2,40

CONTENITORE CON FONDO LISCIO - DIM. INGOMBRO (mm): L=210 P=350 H=145

ART.	multiplo d'ordine	mis.	dim. utili			L	colore	€
			L mm	P mm	H mm			
FAXPB03A2L0513Z	10	3A2	184	296	134	7,5		6,00
FAXPB03A2L0511Z	10	3A2	184	296	134	7,5		6,00
FAXPB03A2L0512Y	10	3A2	184	296	134	7,5		6,00
FAXPB03A2L0515S	10	3A2	184	296	134	7,5		6,00

CONTENITORE CON FONDO LISCIO - DIM. INGOMBRO (mm): L=210 P=350 H=200

ART.	multiplo d'ordine	mis.	dim. utili			L	colore	€
			L mm	P mm	H mm			
FAXPB0003L0513Z	10	3	184	296	188	10		6,90
FAXPB0003L0511Z	10	3	184	296	188	10		6,90
FAXPB0003L0512Y	10	3	184	296	188	10		6,90
FAXPB0003L0515S	10	3	184	296	188	10		6,90

CONTENITORE CON FONDO LISCIO - DIM. INGOMBRO (mm): L=313 P=500 H=145

ART.	multiplo d'ordine	mis.	dim. utili			L	colore	€
			L mm	P mm	H mm			
FAXPB04A2L0513Z	8	4A2	278	445	132	17		12,00
FAXPB04A2L0511Z	8	4A2	278	445	132	17		12,00
FAXPB04A2L0512Y	8	4A2	278	445	132	17		12,00
FAXPB04A2L0515S	8	4A2	278	445	132	17		12,00

CONTENITORE CON FONDO LISCIO - DIM. INGOMBRO (mm): L=313 P=500 H=200

ART.	multiplo d'ordine	mis.	dim. utili			L	colore	€
			L mm	P mm	H mm			
FAXPB0004L0513Z	6	4	278	445	186	24		13,50
FAXPB0004L0511Z	6	4	278	445	186	24		13,50
FAXPB0004L0512Y	6	4	278	445	186	24		13,50
FAXPB0004L0515S	6	4	278	445	186	24		13,50

Portata: 35 kg

CLASSIC

PICKING BOX

RK BOX

EURO BOX

EURO BOX - ESD

VISUAL BOX

MAT

CONTENITORE CON FONDO RINFORZATO - DIM. INGOMBRO (mm): L=313 P=500 H=200



4R



ART.	multiplo d'ordine	mis.	dim. utili			L	colore	€
			L mm	P mm	H mm			
FAXPB0004R05132	6	4	278	445	186	24		14,40

Portata: 50 kg

CONTENITORE CON FONDO LISCIO - DIM. INGOMBRO (mm): L=313 P=500 H=300



4A5



ART.	multiplo d'ordine	mis.	dim. utili			L	colore	€
			L mm	P mm	H mm			
FAXPB04A5L05132	4	4A5	278	445	286	36		16,50
FAXPB04A5L0511Z	4	4A5	278	445	286	36		16,50
FAXPB04A5L0512Y	4	4A5	278	445	286	36		16,50
FAXPB04A5L0515S	4	4A5	278	445	286	36		16,50



CONTENITORE CON FONDO LISCIO - DIM. INGOMBRO (mm): L=102 P=85 H=50



0



ART.	multiplo d'ordine	mis.	dim. utili			L	colore	€
			L mm	P mm	H mm			
FAXPB0000L05132	60	0	86	66	43	0,25		0,90
FAXPB0000L0511Z	60	0	86	66	43	0,25		0,90
FAXPB0000L0512Y	60	0	86	66	43	0,25		0,90
FAXPB0000L0515S	60	0	86	66	43	0,25		0,90

CAPACITÀ

FRONTALINO PER CONTENITORE PICKING BOX CLASSIC

ART.	multiplo d'ordine	adatto per	mis.	€
FAXPBF001000096	10	FAXPB0001L051	1	1,50
FAXPBF002000096	10	FAXPB0002L051	2	0,60
FAXPBF003000096	10	FAXPB0003L051	3	1,50
FAXPBF004000096	10	FAXPB0004L051 FAXPB0004R051	4	2,70
FAXPBF3A2000096	10	FAXPB03A2L051	3A2	0,90
FAXPBF4A2000096	10	FAXPB04A2L051	4A2	3,00
FAXPBF4A5000096	10	FAXPB04A5L051	4A5	3,90

Il frontalino presenta un meccanismo anti-sgancio che evita che il componente si stacchi dall'alloggiamento quando aperto.

PARAPOLVERE PER CONTENITORE PICKING BOX CLASSIC

ART.	multiplo d'ordine	adatto per	mis.	€
FAXPBP002000096	10	FAXPB0002L051	2	5,40
FAXPBP003000096	10	FAXPB0003L051 FAXPB03A2L051	3/3A2	8,40
FAXPBP004000096	10	FAXPB0004L051 FAXPB0004R051 FAXPB04A2L051 FAXPB04A5L051	4/4A2/4A5	12,30

Il parapolvere per contenitore può essere installato in combinazione con il frontalino.

COPERCHIO PER CONTENITORE PICKING BOX CLASSIC

ART.	multiplo d'ordine	adatto per	mis.	€
FAXPBC000005196	10	FAXPB0000L051	0	0,30
FAXPBC001005196	10	FAXPB0001L051	1	0,60
FAXPBC002005196	10	FAXPB0002L051	2	1,80

Il coperchio è dotato di un sistema di apertura push-to-open.



ACCESSORI



DIVISORIO LONGITUDINALE PER CONTENITORE PICKING BOX CLASSIC

ART.	multiplo d'ordine	adatto per	mis.	€
FAXPBD003L07108	10	FAXPB0003L051 FAXPB03A2L051	3/3A2	3,00
FAXPBD004L07108	10	FAXPB0004L051 FAXPB0004R051 FAXPB04A5L051	4/4A5	4,50

Il divisorio longitudinale è installato inserendolo nelle scanalature presenti all'interno del contenitore.



TRAVERSINO PER CONTENITORE PICKING BOX CLASSIC

ART.	multiplo d'ordine	adatto per	mis.	€
FAXPBM004000007	10	FAXPB0004L051 FAXPB0004R051 FAXPB04A2L051 FAXPB04A5L051	4/4A2/4A5	2,40

Il traversino è fissato tramite viti nella parte anteriore del contenitore, in corrispondenza dell'apertura.



PORTA ETICHETTE PER CONTENITORE PICKING BOX CLASSIC

ART.	multiplo d'ordine	adatto per	mis.	€
FAXPBE000P00096	50	FAXPB0000L051	0	0,60
FAXPBE001P00096	50	FAXPB0001L051	1	0,90
FAXPBE002P00096	50	FAXPB0002L051 FAXPB0003L051 FAXPB03A2L051	2/3/3A2	0,90
FAXPBE004P00096	50	FAXPB0004L051 FAXPB0004R051 FAXPB04A2L051	4/4A2	0,90
FAXPBE4A5P00096	50	FAXPB04A5L051	4A5	1,50

Il porta etichette protegge le etichette da polvere e sporcizia ed è inserito nell'alloggiamento frontale del contenitore a bocca di lupo.



ETICHETTE AGGIUNTIVE PER CONTENITORE PICKING BOX CLASSIC

ART.	multiplo d'ordine	n. etichette per foglio	adatto per	mis.	€
FAXPBE000F00013	25	64	FAXPB0000L051	0	0,60
FAXPBE001F00013	25	40	FAXPB0001L051	1	0,90
FAXPBE002F00013	25	16	FAXPB0002L051 FAXPB0003L051 FAXPB03A2L051	2/3/3A2	0,90
FAXPBE004F00013	25	7	FAXPB0004L051 FAXPB0004R051 FAXPB04A2L051	4/4A2	0,90
FAXPBE4A5F00013	25	5	FAXPB04A5L051	4A5	0,90

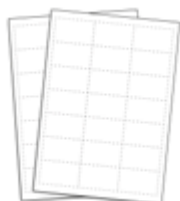

CLASSIC RK BOX

CASSETTE IN PLASTICA
SERIE PRO



Le **cassette RK Box** sono impiegate per lo stoccaggio di minuterie e piccoli componenti e presentano dimensioni tali da poterle custodire all'interno di **scaffali**. I diversi modelli e formati, infatti, possono essere inseriti negli appositi scomparti dei scaffali modulari per creare un **magazzino C-Parts** organizzato ed ordinato. La sovrapposizione è garantita dal design del bordo superiore e del fondo e, grazie alle nervature laterali, non vi è deformazione in quanto il peso viene distribuito lungo tutta la cassetta. RK Box sono dotate di scanalature interne per l'inserimento di divisori longitudinali e trasversali e sono predisposte per l'aggiunta di un pratico coperchio parapolvere così da proteggere il contenuto da sporcizia e polvere.

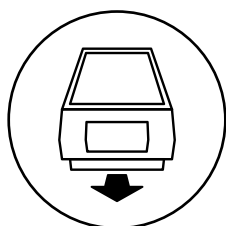

ESTRAIBILE

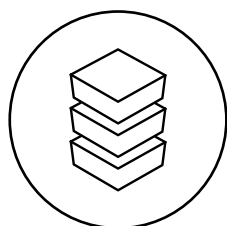

SOVRAPPONIBILE

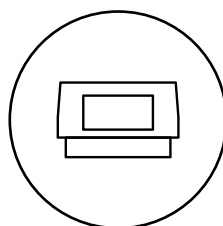

ETICHETTE DI
SERIE

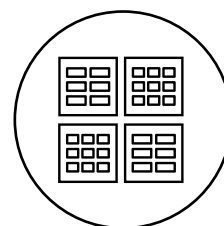

MODULARE

CLASSIC



RK BOX

Le cassette per scaffali sono caratterizzate da:

1. Guide di sospensione con bordi rinforzati
2. Angoli anteriori smussati
3. Portaetichette con etichette di serie
4. Predisposizione per divisorio trasversale
5. Predisposizione per divisorio longitudinale



BORDI RINFORZATI

I bordi rinforzati consentono la sovrapposizione della cassetta e ne evitano la deformazione a causa del peso. Il fondo è liscio e presenta apposite guide per agevolare lo scorrimento di RK Box nelle guide degli scaffali.

DIVISORI

Le scanalature presenti sulle pareti laterali e posteriori agevolano l'inserimento di divisori longitudinali e trasversali per l'organizzazione dello spazio interno.

FERMO

Il fermo posteriore evita la caduta accidentale della cassetta dallo scaffale quando estratta.



SCAFFALE MODULARE

Le cassette RK Box possono essere custodite negli appositi scaffali in acciaio con ripiani per creare un'area di approvvigionamento organizzata. Ogni ripiano, infatti, presenta apposite fessure su cui installare le guide per lo scorrimento delle cassette.

SUDDIVISIONE E PROTEZIONE

Divisorio longitudinale

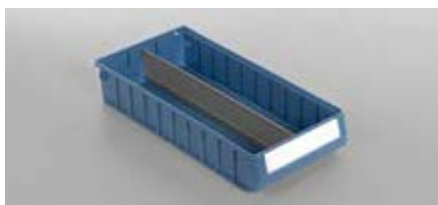

Divisorio trasversale



Parapolvere



CLASSIC

PICKING BOX

RK BOX

EURO BOX

EURO BOX - ESD

VISUAL BOX

MAT

P= 300 mm



CASSETTA CON FONDO LISCIO - DIM. INGOMBRO (mm): L=117 P=300 H=90

ART.	multiplo d'ordine	dim. utili			L	colore	€
		L mm	P mm	H mm			
FAXRK3012L0513K	16	92	259	80	2		4,50



CASSETTA CON FONDO LISCIO - DIM. INGOMBRO (mm): L=156 P=300 H=90

ART.	multiplo d'ordine	dim. utili			L	colore	€
		L mm	P mm	H mm			
FAXRK3016L0513K	12	133	256	80	2,7		5,10



CASSETTA CON FONDO LISCIO - DIM. INGOMBRO (mm): L=234 P=300 H=90

ART.	multiplo d'ordine	dim. utili			L	colore	€
		L mm	P mm	H mm			
FAXRK3024L0513K	8	208	254	80	4,4		5,10

P= 400 mm



CASSETTA CON FONDO LISCIO - DIM. INGOMBRO (mm): L=117 P=400 H=90

ART.	multiplo d'ordine	dim. utili			L	colore	€
		L mm	P mm	H mm			
FAXRK4012L0513K	16	92	358	80	2,7		5,10



CASSETTA CON FONDO LISCIO - DIM. INGOMBRO (mm): L=156 P=400 H=90

ART.	multiplo d'ordine	dim. utili			L	colore	€
		L mm	P mm	H mm			
FAXRK4016L0513K	12	133	356	80	3,8		5,70



CASSETTA CON FONDO LISCIO - DIM. INGOMBRO (mm): L=234 P=400 H=90

ART.	multiplo d'ordine	dim. utili			L	colore	€
		L mm	P mm	H mm			
FAXRK4024L0513K	8	208	354	80	6		7,20

CLASSIC

PICKING BOX **RK BOX** EURO BOX EURO BOX - ESD VISUAL BOX MAT

P= 500 mm



CASSETTA CON FONDO LISCIO - DIM. INGOMBRO (mm): L=117 P=500 H=90

ART.	multiplo d'ordine	dim. utili			L	colore	€
		L mm	P mm	H mm			
FAXRK5012L0513K	16	92	456	80	3,5		5,70



CASSETTA CON FONDO LISCIO - DIM. INGOMBRO (mm): L=156 P=500 H=90

ART.	multiplo d'ordine	dim. utili			L	colore	€
		L mm	P mm	H mm			
FAXRK5016L0513K	12	133	456	80	4,9		6,00



CASSETTA CON FONDO LISCIO - DIM. INGOMBRO (mm): L=234 P=500 H=90

ART.	multiplo d'ordine	dim. utili			L	colore	€
		L mm	P mm	H mm			
FAXRK5024L0513K	8	208	451	80	7,8		7,80





PARAPOLVERE PER CASSETTA RK BOX CLASSIC

ART.	multiplo d'ordine	adatto per	€
FAXRK3P12000096	10	FAXRK3012L051	5,70
FAXRK3P16000096	10	FAXRK3016L051	9,00
FAXRK3P24000096	10	FAXRK3024L051	12,00
FAXRK4P12000096	10	FAXRK4012L051	6,90
FAXRK4P16000096	10	FAXRK4016L051	9,90
FAXRK4P24000096	10	FAXRK4024L051	8,40
FAXRK5P12000096	10	FAXRK5012L051	6,90
FAXRK5P16000096	10	FAXRK5016L051	10,20
FAXRK5P24000096	10	FAXRK5024L051	16,20

Il parapolvere è posizionato nella parte superiore della cassetta e protegge il contenuto da polvere e sporcizia.



DIVISORIO LONGITUDINALE PER CASSETTA RK BOX CLASSIC

ART.	multiplo d'ordine	adatto per	€
FAXRK30D0L00033	10	FAXRK3016L051 FAXRK3024L051	6,60
FAXRK40D0L00033	10	FAXRK4016L051 FAXRK4024L051	6,60
FAXRK50D0L00033	10	FAXRK5016L051	7,80
FAXRK50D0L10033	10	FAXRK5024L051	7,20

Il divisorio longitudinale è installato inserendolo nelle scanalature presenti all'interno della cassetta.



DIVISORIO TRASVERSALE PER CASSETTA RK BOX CLASSIC

ART.	multiplo d'ordine	adatto per	€
FAXRKD012T05196	10	FAXRK3012L051 FAXRK4012L051 FAXRK5012L051	0,60
FAXRKD016T05196	10	FAXRK3016L051 FAXRK4016L051 FAXRK5016L051	0,90
FAXRKD024T05196	10	FAXRK3024L051 FAXRK4024L051 FAXRK5024L051	1,20



Il divisorio trasversale suddivide l'interno della cassetta in più aree per la custodia di minuteria di diverso tipo. È fornito di serie con un'etichetta.



ACCESSORI



PORTA ETICHETTE PER CASSETTA RK BOX CLASSIC

ART.	multiplo d'ordine	adatto per	€
 FAXRKE012P00096	50	FAXRK3012L051 FAXRK4012L051 FAXRK5012L051	0,60
 FAXRKE016P00096	50	FAXRK3016L051 FAXRK4016L051 FAXRK5016L051	0,60
 FAXRKE024P00096	50	FAXRK3024L051 FAXRK4024L051 FAXRK5024L051	0,60

Il porta etichette protegge le etichette da polvere e sporcizia ed è inserito nell'alloggiamento frontale della cassetta RK Box.



ETICHETTE AGGIUNTIVE PER CASSETTA RK BOX CLASSIC

ART.	multiplo d'ordine	n. etichette per foglio	adatto per	€
 FAXRKE012F00013	25	15	FAXRK3012L051 FAXRK4012L051 FAXRK5012L051	1,20
 FAXRKE016F00013	25	10	FAXRK3016L051 FAXRK4016L051 FAXRK5016L051	1,20
 FAXRKE024F00013	25	7	FAXRK3024L051 FAXRK4024L051 FAXRK5024L051	1,20



CLASSIC

PICKING BOX

RK BOX

EURO BOX

EURO BOX - ESD

VISUAL BOX

MAT

P= 300 mm



SCAFFALE CON 16 CASSETTE RK BOX CLASSIC

ART.	L mm	P mm	H mm	n. contenitori	RAL	€
 RKBOX3001	496	304	546	16 x FAXRK3012L0513K	7000	212,10

Completo di guide e fermi posteriori



SCAFFALE CON 12 CASSETTE RK BOX CLASSIC

ART.	L mm	P mm	H mm	n. contenitori	RAL	€
 RKBOX3002	496	304	546	12 x FAXRK3016L0513K	7000	208,50

Completo di guide e fermi posteriori



SCAFFALE CON 8 CASSETTE RK BOX CLASSIC

ART.	L mm	P mm	H mm	n. contenitori	RAL	€
 RKBOX3003	496	304	546	8 x FAXRK3024L0513K	7000	165,30

Completo di guide e fermi posteriori

P= 400 mm



SCAFFALE CON 16 CASSETTE RK BOX CLASSIC

ART.	L mm	P mm	H mm	n. contenitori	RAL	€
 RKBOX4001	496	404	546	16 x FAXRK4012L0513K	7000	228,90

Completo di guide e fermi posteriori



SCAFFALE CON 12 CASSETTE RK BOX CLASSIC

ART.	L mm	P mm	H mm	n. contenitori	RAL	€
 RKBOX4002	496	404	546	12 x FAXRK4016L0513K	7000	222,90

Completo di guide e fermi posteriori



SCAFFALE CON 8 CASSETTE RK BOX CLASSIC

ART.	L mm	P mm	H mm	n. contenitori	RAL	€
 RKBOX4003	496	404	546	8 x FAXRK4024L0513K	7000	189,30

Completo di guide e fermi posteriori

P= 500 mm



SCAFFALE CON 16 CASSETTE RK BOX CLASSIC

ART.	L mm	P mm	H mm	n. contenitori	RAL	€
 RKBOX5001	496	504	546	16 x FAXRK5012L0513K	7000	248,10

Completo di guide e fermi posteriori



SCAFFALE CON 12 CASSETTE RK BOX CLASSIC

ART.	L mm	P mm	H mm	n. contenitori	RAL	€
 RKBOX5002	496	504	546	12 x FAXRK5016L0513K	7000	235,80

Completo di guide e fermi posteriori



SCAFFALE CON 8 CASSETTE RK BOX CLASSIC

ART.	L mm	P mm	H mm	n. contenitori	RAL	€
 RKBOX5003	496	504	546	8 x FAXRK5024L0513K	7000	203,10





Completo di guide e fermi posteriori



COMPONENTI PER SCAFFALI PER RK BOX CLASSIC





SCAFFALE VUOTO

ART.	L mm	P mm	H mm	n. ripiani	RAL	€
 FRK BX30050001	496	304	546	5	7000	99,90
 FRK BX30050008	496	304	546	5	7035	99,90
 FRK BX40050001	496	404	546	5	7000	107,10
 FRK BX50050001	496	504	546	5	7000	115,80





KIT 4 GUIDE PER SCAFFALE

ART.	per scaffale P mm	finitura	€
 FRK BX30KG0499	300	Zincato	5,40
 FRK BX40KG0499	400	Zincato	5,40
 FRK BX50KG0499	500	Zincato	5,70



KIT FERMI POSTERIORI PER CASSETTE RK BOX CLASSIC

ART.	n. fermi	adatto per	finitura	€
 FRK BX00KS1699	16	FAXRK3012L051 FAXRK4012L051 FAXRK5012L051	Zincato	24,00
 FRK BX00KS1299	12	FAXRK3016L051 FAXRK4016L051 FAXRK5016L051	Zincato	36,60
 FRK BX00KS0899	8	FAXRK3024L051 FAXRK4024L051 FAXRK5024L051	Zincato	19,20





La struttura modulare consente di impilare scaffali con la medesima profondità o con profondità decrescente.

Ogni scaffale, infatti, presenta delle alette nella parte superiore per sovrapporre in modo stabile e sicuro i diversi moduli.



 RAL 7000

 RAL 7035

 ZINCATO

CLASSIC EURO BOX

CASSETTE IN PLASTICA
SERIE PRO



Le **Euro Box** sono tipicamente utilizzate per l'organizzazione di magazzini e, soprattutto, nella distribuzione e nella logistica. Queste cassette, infatti, presentano dimensioni compatibili con gli **Euro pallet** per l'ottimizzazione del carico durante il trasporto. Euro Box è disponibile in diverse varianti in base alla tipologia di maniglia (chiusa, aperta, a conchiglia) o fondo scelto (liscio o rinforzato). I bordi rinforzati rendono l'intera struttura più solida e robusta e consentono la sovrapposizione di più cassette sia con che senza coperchio. Cassette divisorio e divisori a pettine in polipropilene sono disponibili per la suddivisione interna del contenitore e per una migliore gestione del materiale da stoccare.

Le **Euro Box ESD** sono realizzate in polipropilene conduttivo per l'impiego in ambienti a rischio di scariche elettrostatiche.

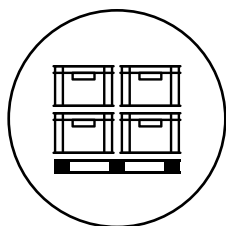

MISURE
COMPATIBILI CON
EUROPALLET

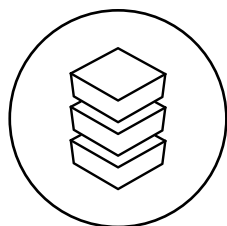

SOVRAPPONIBILE

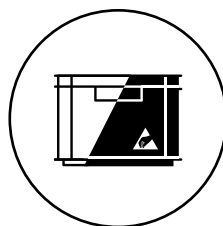

POLIPROPILENE O
POLIPROPILENE
ESD

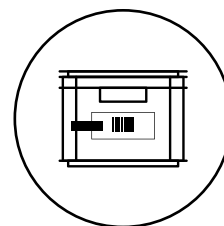

AMPIA GAMMA
ACCESSORI

CLASSIC



EURO BOX

Le cassette sono caratterizzate da:

1. Pareti rinforzate
2. Predisposizione per coperchio
3. Maniglie (aperte, chiuse o a conchiglia)
4. Fondo liscio o rinforzato

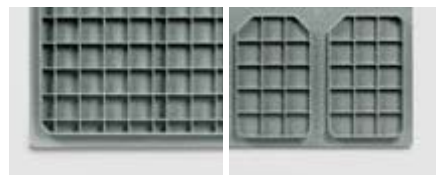

BORDI RINFORZATI

I bordi rinforzati irrobustiscono l'intera struttura, rendendola resistente a carichi pesanti in caso di sovrapposizione. Quest'ultima può avvenire anche se è presente il coperchio a cerniera.

MANIGLIE

Oltre alle tradizionali maniglie chiuse o aperte, Euro Box è disponibile anche con maniglia a conchiglia.

FONDO

Le cassette Euro Box sono disponibili con fondo liscio o fondo rinforzato per una capacità di carico più elevata.



POLIPROPILENE ESD

Le Euro Box in polipropilene ESD possono essere impiegate per la custodia e il trasporto di prodotti elettronici in quanto proteggono il contenuto da possibili scariche elettrostatiche.



MARCHIATURA PERSONALIZZATA

Su richiesta è possibile marciare le cassette Euro Box con il nome o logo aziendale.

SUDDIVISIONE E PROTEZIONE

Cassette divisorio 400x300



Cassette divisorio 600x400



Divisori a pettine



Porta Etichetta



Chiusura



CLASSIC

PICKING BOX

RK BOX

EURO BOX

EURO BOX - ESD

VISUAL BOX

MAT

300x200 mm



COPERCHIO A CERNIERA

ART.	L mm	P mm	H mm	colore	€
FAXEB32C0005137	300	200	22		2,40

CASSETTA CON FONDO LISCIO - DIM. INGOMBRO (mm): L=300 P=200 H=120

ART.	dim. utili				colore	€
	L mm	P mm	H mm			
FAXEB3212L15137	260	160	117	4,9		4,50



CASSETTA CON FONDO LISCIO - DIM. INGOMBRO (mm): L=300 P=200 H=147

ART.	dim. utili				colore	€
	L mm	P mm	H mm			
FAXEB3215L15137	260	160	145	6		5,10



CASSETTA CON FONDO LISCIO - DIM. INGOMBRO (mm): L=300 P=200 H=220

ART.	dim. utili				colore	€
	L mm	P mm	H mm			
FAXEB3222L15137	260	160	218	9,1		6,00



400x300 mm



COPERCHIO A CERNIERA

ART.	L mm	P mm	H mm	colore	€
FAXEB43C0005137	400	300	22		4,20

CASSETTA CON FONDO LISCIO - DIM. INGOMBRO (mm): L=400 P=300 H=120

ART.	dim. utili				colore	€
	L mm	P mm	H mm			
FAXEB4312L15137	360	258	118	11		7,20



CASSETTA CON FONDO LISCIO - DIM. INGOMBRO (mm): L=400 P=300 H=170

ART.	dim. utili				colore	€
	L mm	P mm	H mm			
FAXEB4317L05137	358	258	168	15,5		8,40



CLASSIC

400x300 mm

PICKING BOX RK BOX **EURO BOX** EURO BOX - ESD VISUAL BOX MAT



CASSETTA CON FONDO LISCIO - DIM. INGOMBRO (mm): L=400 P=300 H=220

ART.	dim. utili			L	colore	€
	L mm	P mm	H mm			
FAXEB4322L05137	358	258	217	19,9		10,80



CASSETTA CON FONDO RINFORZATO - DIM. INGOMBRO (mm): L=400 P=300 H=220

ART.	dim. utili			L	colore	€
	L mm	P mm	H mm			
FAXEB4322R05137	358	258	205	18,9		14,10



CASSETTA CON FONDO LISCIO - DIM. INGOMBRO (mm): L=400 P=300 H=270

ART.	dim. utili			L	colore	€
	L mm	P mm	H mm			
FAXEB4327L05137	358	256	267	24,3		14,40



CASSETTA CON FONDO RINFORZATO - DIM. INGOMBRO (mm): L=400 P=300 H=270

ART.	dim. utili			L	colore	€
	L mm	P mm	H mm			
FAXEB4327R05137	358	256	255	23,4		15,90



CASSETTA CON FONDO LISCIO - DIM. INGOMBRO (mm): L=400 P=300 H=320

ART.	dim. utili			L	colore	€
	L mm	P mm	H mm			
FAXEB4332L05137	358	256	316	29		16,20



CASSETTA CON FONDO RINFORZATO - DIM. INGOMBRO (mm): L=400 P=300 H=320

ART.	dim. utili			L	colore	€
	L mm	P mm	H mm			
FAXEB4332R05137	358	256	305	28		16,80





CLASSIC

600x400 mm





PICKING BOX RK BOX **EURO BOX** EURO BOX - ESD VISUAL BOX MAT

COPERCHIO A CERNIERA



ART.	L mm	P mm	H mm	colore	€
 FAXEB64C0005137	600	400	22		7,80

CASSETTA CON FONDO LISCIO - DIM. INGOMBRO (mm): L=600 P=400 H=75

ART.	dim. utili				colore	€
	L mm	P mm	H mm			
 FAXEB6408L05137	555	355	72	14,2		10,20





CASSETTA CON FONDO LISCIO - DIM. INGOMBRO (mm): L=600 P=400 H=120

ART.	dim. utili				colore	€
	L mm	P mm	H mm			
 FAXEB6412L15137	555	358	115	22,8		11,70





CASSETTA CON FONDO RINFORZATO - DIM. INGOMBRO (mm): L=600 P=400 H=115

ART.	dim. utili				colore	€
	L mm	P mm	H mm			
 FAXEB6412R15137	555	358	100	19,9		14,10





CASSETTA CON FONDO LISCIO - DIM. INGOMBRO (mm): L=600 P=400 H=150

ART.	dim. utili				colore	€
	L mm	P mm	H mm			
 FAXEB6415L05137	553	353	145	28,3		14,10



CASSETTA CON FONDO RINFORZATO - DIM. INGOMBRO (mm): L=600 P=400 H=150

ART.	dim. utili				colore	€
	L mm	P mm	H mm			
 FAXEB6415R25137	553	353	130	25,4		16,50



CLASSIC

600x400 mm

PICKING BOX	RK BOX	EURO BOX	EURO BOX - ESD	VISUAL BOX	MAT
-------------	--------	-----------------	----------------	------------	-----

CASSETTA CON FONDO LISCIO - DIM. INGOMBRO (mm): L=600 P=400 H=170



ART.	dim. utili			L	colore	€
	L mm	P mm	H mm			
FAXEB6417L05137	555	355	165	32,5		13,50



CASSETTA CON FONDO RINFORZATO - DIM. INGOMBRO (mm): L=600 P=400 H=170



ART.	dim. utili			L	colore	€
	L mm	P mm	H mm			
FAXEB6417R25137	555	355	152	29,9		16,20



CASSETTA CON FONDO LISCIO - DIM. INGOMBRO (mm): L=600 P=400 H=220



ART.	dim. utili			L	colore	€
	L mm	P mm	H mm			
FAXEB6422L05137	555	358	217	43,1		15,60



CASSETTA CON FONDO RINFORZATO - DIM. INGOMBRO (mm): L=600 P=400 H=215



ART.	dim. utili			L	colore	€
	L mm	P mm	H mm			
FAXEB6422R25137	555	358	200	39,7		18,30



CASSETTA CON FONDO LISCIO - DIM. INGOMBRO (mm): L=600 P=400 H=236



ART.	dim. utili			L	colore	€
	L mm	P mm	H mm			
FAXEB6424L05137	555	357	231	45,8		17,40



CASSETTA CON FONDO RINFORZATO - DIM. INGOMBRO (mm): L=600 P=400 H=232



ART.	dim. utili			L	colore	€
	L mm	P mm	H mm			
FAXEB6424R25137	555	357	215	42,6		19,80



- FONDO LISCIO
- FONDO RINFORZATO
- PARETI CHIUSE
- MANIGLIA CONCHIGLIA
- MANIGLIE CHIUSE
- MANIGLIE APERTE
- CAPACITÀ

CLASSIC

600x400 mm

PICKING BOX	RK BOX	EURO BOX	EURO BOX - ESD	VISUAL BOX	MAT
-------------	--------	-----------------	----------------	------------	-----



CASSETTA CON FONDO LISCIO - DIM. INGOMBRO (mm): L=600 P=400 H=280

ART.	dim. utili			L	colore	€
	L mm	P mm	H mm			
FAXEB6428L05137	553	355	277	54,4		20,10



CASSETTA CON FONDO RINFORZATO - DIM. INGOMBRO (mm): L=600 P=400 H=280

ART.	dim. utili			L	colore	€
	L mm	P mm	H mm			
FAXEB6428R25137	553	355	260	51		24,00



CASSETTA CON FONDO LISCIO - DIM. INGOMBRO (mm): L=600 P=400 H=320

ART.	dim. utili			L	colore	€
	L mm	P mm	H mm			
FAXEB6432L05137	551	352	318	60,3		21,00



CASSETTA CON FONDO RINFORZATO - DIM. INGOMBRO (mm): L=600 P=400 H=320

ART.	dim. utili			L	colore	€
	L mm	P mm	H mm			
FAXEB6432R25137	552	352	306	58,5		24,00



CASSETTA CON FONDO LISCIO - DIM. INGOMBRO (mm): L=600 P=400 H=423

ART.	dim. utili			L	colore	€
	L mm	P mm	H mm			
FAXEB6442L05137	555	355	420	82,8		28,20



CASSETTA CON FONDO RINFORZATO - DIM. INGOMBRO (mm): L=600 P=400 H=418

ART.	dim. utili			L	colore	€
	L mm	P mm	H mm			
FAXEB6442R25137	555	355	400	78,8		30,60



CLASSIC

PICKING BOX

RK BOX

EURO BOX

EURO BOX - ESD

VISUAL BOX

MAT

800x600 mm



CASSETTA CON FONDO MODULARE - DIM. INGOMBRO (mm): L=800 P=600 H=320

ART.	dim. utili			L	colore	€
	L mm	P mm	H mm			
FAXEB8632M25137	753	552	297	123,4	■	42,00



⚠ Questo modello presenta maniglie su tutti i lati



 FONDO LISCIO

 FONDO RINFORZATO

 FONDO MODULARE

 PARETI CHIUSE

 MANIGLIE CHIUSE

 MANIGLIE APERTE

 CAPACITÀ

CASSETTE DIVISORIO PER CASSETTE 400x300 mm

SCHEMA PARTIZIONI

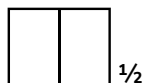

CASSETTA DIVISORIO PER CASSETTA EURO BOX - DIM. INGOMBRO (mm): L=250 P=175 H=95



ART.	partizione	dim. utili			L	colore	€
		L mm	P mm	H mm			
FAXEB43S0025137	1/2	242	158	88	3,3		6,30



Esempio di partizione delle cassette Euro Box 400x300 mm con cassette divisorio (2 x FAXEB43S0025137)



Esempio di partizione delle cassette Euro Box 600x400 mm con cassette divisorio (1 x FAXEB64S1085137, 2 x FAXEB64S0165137, 1 x FAXEB64S0047137, 2 x FAXEB64S0085137, 1 x FAXEB64S1045137)

CASSETTE DIVISORIO PER CASSETTE 600x400 mm

SCHEMA PARTIZIONI

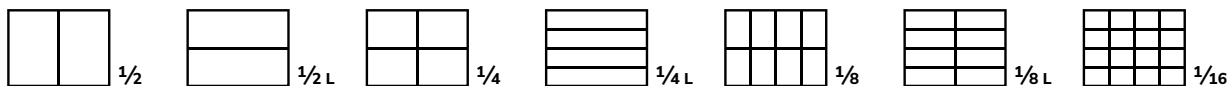

CASSETTA DIVISORIO PER CASSETTA EURO BOX - DIM. INGOMBRO (mm): L=550 P=174 H=110



ART.	partizione	dim. utili			L	colore	€
		L mm	P mm	H mm			
FAXEB64S0027137	1/2	544	168	105	9,6	■	14,40

CASSETTA DIVISORIO PER CASSETTA EURO BOX - DIM. INGOMBRO (mm): L=550 P=87 H=110



ART.	partizione	dim. utili			L	colore	€
		L mm	P mm	H mm			
FAXEB64S0047137	1/4	544	81	105	4,6	■	11,10

CASSETTA DIVISORIO PER CASSETTA EURO BOX - DIM. INGOMBRO (mm): L=137 P=174 H=110



ART.	partizione	dim. utili			L	colore	€
		L mm	P mm	H mm			
FAXEB64S0085137	1/8	131	168	105	2,3	■	3,90

CASSETTA DIVISORIO PER CASSETTA EURO BOX - DIM. INGOMBRO (mm): L=137 P=87 H=110



ART.	partizione	dim. utili			L	colore	€
		L mm	P mm	H mm			
FAXEB64S0165137	1/16	132	82	105	1,1	■	2,70

CASSETTA DIVISORIO PER CASSETTA EURO BOX - DIM. INGOMBRO (mm): L=274 P=350 H=110



ART.	partizione	dim. utili			L	colore	€
		L mm	P mm	H mm			
FAXEB64S1025137	1/2	268	344	105	9,7	■	11,10

CASSETTA DIVISORIO PER CASSETTA EURO BOX - DIM. INGOMBRO (mm): L=274 P=174 H=110



ART.	partizione	dim. utili			L	colore	€
		L mm	P mm	H mm			
FAXEB64S1045137	1/4	268	168	105	4,7	■	6,00

CASSETTA DIVISORIO PER CASSETTA EURO BOX - DIM. INGOMBRO (mm): L=274 P=87 H=110



ART.	partizione	dim. utili			L	colore	€
		L mm	P mm	H mm			
FAXEB64S1085137	1/8	268	82	105	2,3	■	4,80

PORTA ETICHETTE PER CASSETTA DIVISORIO



ART.	L mm	H mm	€
FAXEB00PE010096	74	104	7,20

ACCESSORI



CARRELLO CON RUOTE PER CASSETTA EURO BOX 600X400

ART.	L mm	P mm	H mm	KG	colore	€
FAXEB64R0006103	620	420	170	250		84,00
FAXEB64R0006104	620	420	170	250		84,00

DIVISORIO A PETTINE IN POLIPROPILENE PER CASSETTA EURO BOX 600X400

ART.	L mm	P mm	H mm	colore	€
FAXEB4D10005137	352	4	100		1,50

DIVISORIO A PETTINE IN POLIPROPILENE PER CASSETTA EURO BOX 600X400

ART.	L mm	P mm	H mm	colore	€
FAXEB6D10005137	552	4	100		1,80

I divisori a pettine hanno un sistema di installazione ad incastro per una suddivisione modulare e flessibile dell'interno della cassetta.



CLIP PORTA ETICHETTE PER CASSETTA EURO BOX

ART.	L mm	P mm	H mm	finitura	€
FAXEB00PE000099	84	13	20	Zincato	1,50

Il porta etichette è installato sulle nervature della cassetta.



CHIUSURA A SCATTO PER COPERCHIO EURO BOX

ART.	L mm	P mm	H mm	€
FAXEBSCC0000013	32	8	26	0,30

Inserita nei fori del coperchio e del bordo della cassetta, blocca il coperchio evitandone l'apertura accidentale.





PORTATA



ZINCATO

CLASSIC

PICKING BOX

RK BOX

EURO BOX

EURO BOX - ESD

VISUAL BOX

MAT

400x300 mm



COPERCHIO ESD A CERNIERA

ART.	L mm	P mm	H mm	colore	€
FAXEB43C0005207	400	300	22		6,30



CASSETTA ESD CON FONDO LISCIO - DIM. INGOMBRO (mm): L=400 P=300 H=220

ART.	dim. utili				colore	€
	L mm	P mm	H mm			
FAXEB4322L05207	358	258	217	19,9		20,70



600x400 mm



COPERCHIO ESD A CERNIERA

ART.	L mm	P mm	H mm	colore	€
FAXEB64C0005207	600	400	22		12,00



CASSETTA ESD CON FONDO LISCIO - DIM. INGOMBRO (mm): L=600 P=400 H=75

ART.	dim. utili				colore	€
	L mm	P mm	H mm			
FAXEB6408L05207	555	355	72	14,2		20,40



CASSETTA ESD CON FONDO LISCIO - DIM. INGOMBRO (mm): L=600 P=400 H=120

ART.	dim. utili				colore	€
	L mm	P mm	H mm			
FAXEB6412L15207	555	358	115	22,8		24,30



CASSETTA ESD CON FONDO LISCIO - DIM. INGOMBRO (mm): L=600 P=400 H=220

ART.	dim. utili				colore	€
	L mm	P mm	H mm			
FAXEB6422L05207	555	358	217	43,1		38,70



CLASSIC

ACCESSORI

PICKING BOX

RK BOX

EURO BOX



EURO BOX - ESD

VISUAL BOX

MAT



CARRELLO ESD CON RUOTE PER CASSETTA EURO BOX 600X400

ART.	L mm	P mm	H mm	KG	colore	€
 FAXEB64R0006207	620	420	170	250		240,00



CHIUSURA A SCORRIMENTO IN POLIPROPILENE CONDUTTIVO PER COPERCHIO EURO BOX

ART.	L mm	P mm	H mm	€
 FAXEBSMC0005207	44	9	24	0,30



FONDO LISCIO



PARETI CHIUSE



MANIGLIE A CONCHIGLIA



MANIGLIE CHIUSE



CAPACITÀ

CLASSIC VISUAL BOX

CONTENITORI IN PLASTICA
SERIE PRO



Visual Box è il sistema modulare di **cassettiere portaminuteria** caratterizzato da cassette trasparenti con **apertura basculante**. Ogni cassettera è composta da due elementi: un robusto e resistente corpo in polistirolo e un numero variabile di cassette infrangibili in copolimero di stirene trasparente. La trasparenza e la modalità di apertura di quest'ultimi **agevola la visione e l'estrazione del contenuto stoccato**. Indipendentemente dal numero di cassette scelti, i diversi modelli di Visual Box presentano la medesima larghezza per poterli **sovrapporre** e creare magazzini portaminuteria modulari ed espandibili in qualsiasi momento. Queste soluzioni sono integrabili in numerosi arredi, quali banchi o bracci estensibili, oppure possono essere installate su telai per creare scaffali portaminuteria da parete.

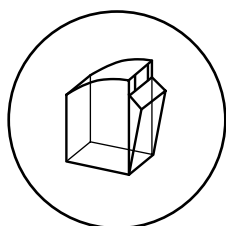

**CASSETTI
TRASPARENTI CON
APERTURA
BASCULANTE**

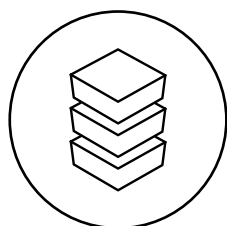

**SOVRAPPONIBILE
E COMPATIBILE**

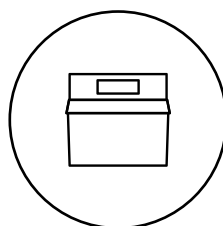

**ETICHETTE DI
SERIE**

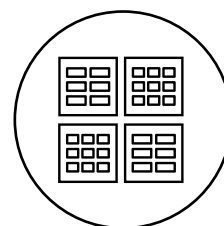

MODULARE

CLASSIC



VISUAL BOX

Le cassettiere portaminuteria con cassetti con apertura basculante sono caratterizzati da:

1. Cassetto trasparente
2. Apertura basculante
3. Porta etichette con etichette
4. Gancio per sovrapposizione



ALTA VISIBILITÀ

I cassetti in copolimero di stirene trasparente sono infrangibili e facilitano la visione e l'identificazione del contenuto di ogni Visual Box.



MANIGLIA CON ETICHETTE

Tutti i cassetti dispongono di un portaetichetta nella parte superiore per catalogare il contenuto. Frontalmente è presente una maniglia per l'apertura ergonomica del cassetto.



SOVRAPPONIBILITÀ

Il gancio installato nella parte superiore di Visual Box consente di sovrapporre ogni modulo in modo stabile e sicuro.

In caso di sovrapposizione di Visual Box con profondità diverse, l'installazione della cassettiere con profondità inferiore può avvenire frontalmente o posteriormente.



TELAJ PER VISUAL BOX

I telai per Visual Box da 500 mm di altezza sono sovrapponibili tramite un apposito sistema di incastro brevettato per creare magazzini modulari alti massimo 2000 mm su cui organizzare le diverse cassettiere Visual Box.

CASSETTIERA VISUAL BOX CON 9 CASSETTI

DIM. INGOMBRO (mm): L=600 P=68 H=78



ART.	multiplo d'ordine	cassetti				colore	€
		n.	L mm	P mm	H mm		
FAXVBCH00900001	1	9	56	43	47		12,60
FAXVBCH00900039	1	9	56	43	47		12,60

CASSETTIERA VISUAL BOX CON 6 CASSETTI

DIM. INGOMBRO (mm): L=600 P=96 H=112



ART.	multiplo d'ordine	cassetti				colore	€
		n.	L mm	P mm	H mm		
FAXVBCH00600001	1	6	88	65	70		14,70
FAXVBCH00600039	1	6	88	65	70		14,70

CASSETTIERA VISUAL BOX CON 5 CASSETTI

DIM. INGOMBRO (mm): L=600 P=140 H=168



ART.	multiplo d'ordine	cassetti				colore	€
		n.	L mm	P mm	H mm		
FAXVBCH00500001	1	5	108	98	107		23,40
FAXVBCH00500039	1	5	108	98	107		23,40

CASSETTIERA VISUAL BOX CON 4 CASSETTI

DIM. INGOMBRO (mm): L=600 P=178 H=206



ART.	multiplo d'ordine	cassetti				colore	€
		n.	L mm	P mm	H mm		
FAXVBCH00400001	1	4	138	127	134		32,40
FAXVBCH00400039	1	4	138	127	134		32,40

CASSETTIERA VISUAL BOX CON 3 CASSETTI

DIM. INGOMBRO (mm): L=600 P=210 H=242



ART.	multiplo d'ordine	cassetti				colore	€
		n.	L mm	P mm	H mm		
FAXVBCH00300001	1	3	180	145	161		39,60
FAXVBCH00300039	1	3	180	145	161		39,90

FERMO PER CASSETTIERA VISUAL BOX



ART.	adatto per	€
FAXVBCHL0900099	FAXVBCH009000	1,80
FAXVBCHL0600099	FAXVBCH006000	1,80
FAXVBCHL0500099	FAXVBCH005000	1,80
FAXVBCHL0400099	FAXVBCH004000	1,80
FAXVBCHL0300099	FAXVBCH003000	1,80

COMPONENTI



TELAIO DA PARETE PER CASSETTIERE VISUAL BOX

ART.	L mm	P mm	H mm	materiale	€
FVB100TEL0000	602	22	1000	Alluminio	57,00
FVB150TEL0000	602	22	1500	Alluminio	64,50
FVB200TEL0000	602	22	2000	Alluminio	74,40



BASE PER SCAFFALE VISUAL BOX

ART.	L mm	P mm	H mm	RAL	€
FVB100BAS0001	604	322	100	7000	36,90
FVB100BAS0039	604	322	100	7016	38,40



TELAIO MODULARE E SOVRAPPONIBILE PER CASSETTIERE VISUAL BOX

ART.	L mm	P mm	H mm	materiale	€
FVB050TEL0000	602	22	500	Alluminio	30,00

ART. FVB050TEL0000 x2
H= 1000



ART. FVB050TEL0000 x3
H= 1500



ART. FVB050TEL0000 x4
H= 2000



TRAVERSO DA PARETE CON FERMO VISUAL BOX

ART.	L mm	P mm	H mm	finitura	€
FVB090TRA0099	601	42	88	Zincato	10,20

Consente il fissaggio sospeso da terra degli scaffali con altezza 500 e 1000 mm.



CLASSIC

H= 500 mm

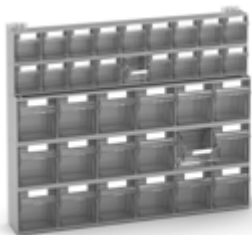

SCAFFALE CON 36 CASSETTI VISUAL BOX
 DIM. INGOMBRO (mm): L=602 P=114 H=500

ART.	descrizione	colore	€
FVB00101	1 x FVB050TEL0000 2 x FAXVBCH00900001 3 x FAXVBCH00600001		99,30



SCAFFALE CON 23 CASSETTI VISUAL BOX
 DIM. INGOMBRO (mm): L=602 P=157 H=500

ART.	descrizione	colore	€
FVB00201	1 x FVB050TEL0000 3 x FAXVBCH00600001 1 x FAXVBCH00500001		97,50

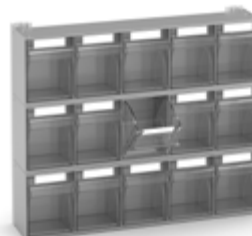

SCAFFALE CON 15 CASSETTI VISUAL BOX
 DIM. INGOMBRO (mm): L=602 P=157 H=500

ART.	descrizione	colore	€
FVB00301	1 x FVB050TEL0000 3 x FAXVBCH00500001		100,20

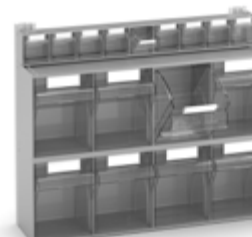

SCAFFALE CON 17 CASSETTI VISUAL BOX
 DIM. INGOMBRO (mm): L=602 P=190 H=500

ART.	descrizione	colore	€
FVB00401	1 x FVB050TEL0000 1 x FAXVBCH00900001 2 x FAXVBCH00400001		107,40

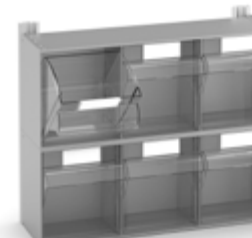

SCAFFALE CON 6 CASSETTI VISUAL BOX
 DIM. INGOMBRO (mm): L=602 P=225 H=500

ART.	descrizione	colore	€
FVB00501	1 x FVB050TEL0000 2 x FAXVBCH00300001		109,20

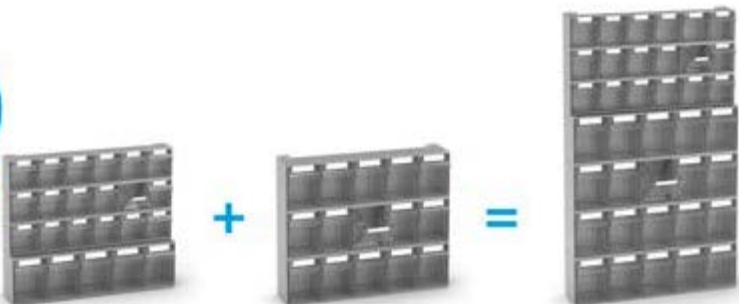

Gli scaffali da 500 mm di altezza sono sovrapponibili per creare strutture con altezza variabile (1000, 1500 o 2000 mm).

H= 1000 mm

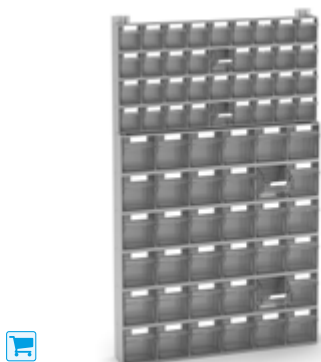

SCAFFALE CON 72 CASSETTI VISUAL BOX
DIM. (mm): L=602 P=114 H=1000

ART.	descrizione	€
VISUAL001	2 x FVB00101	198,60

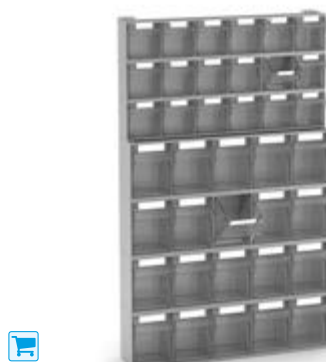

SCAFFALE CON 38 CASSETTI VISUAL BOX
DIM. (mm): L=602 P=157 H=1000

ART.	descrizione	€
VISUAL002	1 x FVB00201 1 x FVB00301	197,70

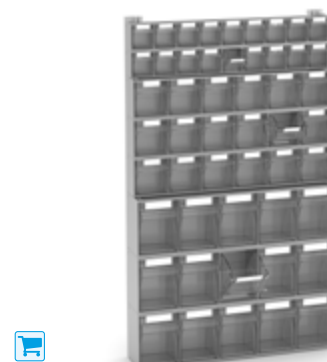

SCAFFALE CON 51 CASSETTI VISUAL BOX
DIM. (mm): L=602 P=157 H=1000

ART.	descrizione	€
VISUAL003	1 x FVB00101 1 x FVB00301	199,50

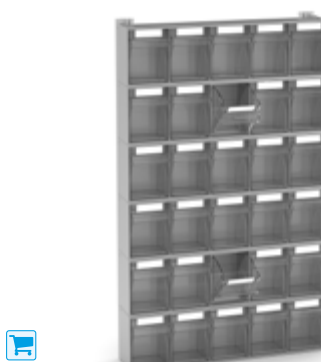

SCAFFALE CON 30 CASSETTI VISUAL BOX
DIM. (mm): L=602 P=157 H=1000

ART.	descrizione	€
VISUAL004	2 x FVB00301	200,40

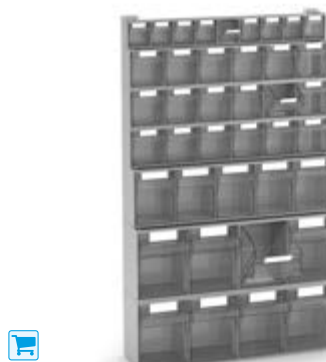

SCAFFALE CON 40 CASSETTI VISUAL BOX
DIM. (mm): L=602 P=190 H=1000

ART.	descrizione	€
VISUAL005	1 x FVB00201 1 x FVB00401	204,90

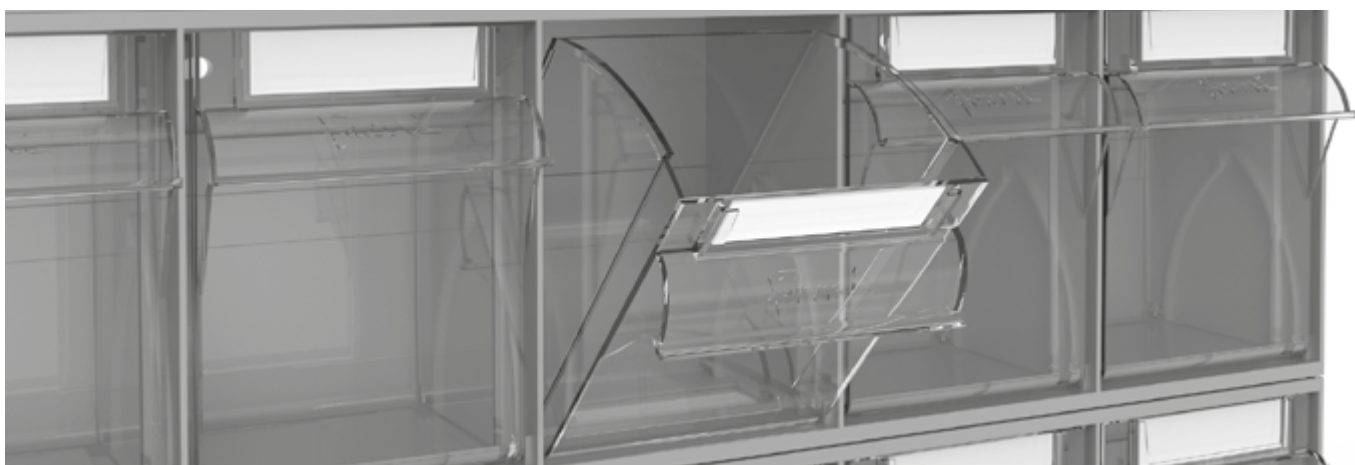

H= 1500 mm



SCAFFALE CON 108 CASSETTI VISUAL BOX
DIM. (mm): L=602 P=114 H=1500

ART.	descrizione	€
VISUAL006	3 x FVB00101	297,90



SCAFFALE CON 87 CASSETTI VISUAL BOX
DIM. (mm): L=602 P=157 H=1500

ART.	descrizione	€
VISUAL007	2 x FVB00101 1 x FVB00301	298,80



SCAFFALE CON 45 CASSETTI VISUAL BOX
DIM. (mm): L=602 P=157 H=1500

ART.	descrizione	€
VISUAL008	3 x FVB00301	300,60



SCAFFALE CON 55 CASSETTI VISUAL BOX
DIM. (mm): L=602 P=190 H=1500

ART.	descrizione	€
VISUAL009	1 x FVB00201 1 x FVB00301 1 x FVB00401	305,10

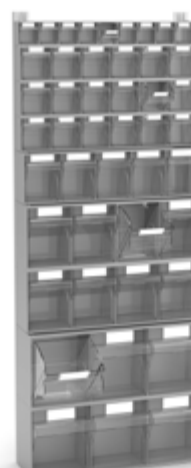

SCAFFALE CON 46 CASSETTI VISUAL BOX
DIM. (mm): L=602 P=225 H=1500

ART.	descrizione	€
VISUAL010	1 x FVB00201 1 x FVB00401 1 x FVB00501	314,10



H= 2000 mm



SCAFFALE CON 144 CASSETTI VISUAL BOX
DIM. (mm): L=602 P=114 H=2000

ART.	descrizione	€
VISUAL011	4 x FVB00101	397,20

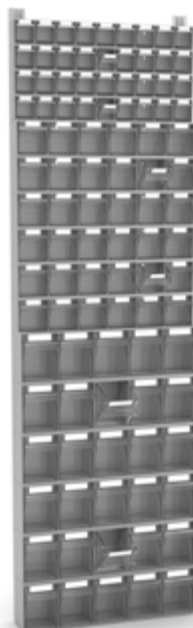

SCAFFALE CON 102 CASSETTI VISUAL BOX
DIM. (mm): L=602 P=157 H=2000

ART.	descrizione	€
VISUAL012	2 x FVB00101 2 x FVB00301	399,00

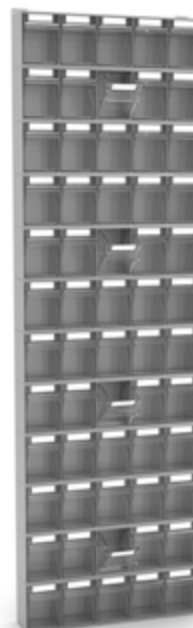

SCAFFALE CON 60 CASSETTI VISUAL BOX
DIM. (mm): L=602 P=157 H=2000

ART.	descrizione	€
VISUAL013	4 x FVB00301	400,80

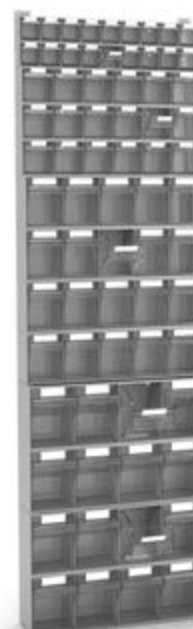

SCAFFALE CON 72 CASSETTI VISUAL BOX
DIM. (mm): L=602 P=190 H=2000

ART.	descrizione	€
VISUAL014	1 x FVB00201 1 x FVB00301 2 x FVB00401	412,50

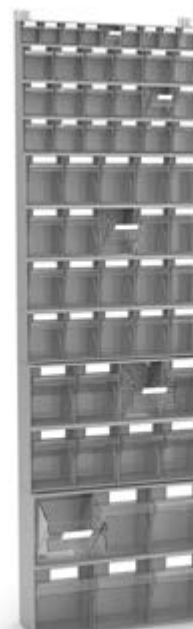

SCAFFALE CON 61 CASSETTI VISUAL BOX
DIM. (mm): L=602 P=225 H=2000

ART.	descrizione	€
VISUAL015	1 x FVB00201 1 x FVB00301 1 x FVB00401 1 x FVB00501	414,30



H= 1500 mm



SCAFFALE CON 108 CASSETTI VISUAL BOX
DIM. (mm): L=604 P=322 H=1600

ART.	descrizione	€
VISUAL016	3 x FVB00101 1 x FVB100BAS0001	334,80



SCAFFALE CON 87 CASSETTI VISUAL BOX
DIM. (mm): L=604 P=322 H=1600

ART.	descrizione	€
VISUAL017	2 x FVB00101 1 x FVB00301 1 x FVB100BAS0001	335,70



SCAFFALE CON 45 CASSETTI VISUAL BOX
DIM. (mm): L=604 P=322 H=1600

ART.	descrizione	€
VISUAL018	3 x FVB00301 1 x FVB100BAS0001	337,50



SCAFFALE CON 55 CASSETTI VISUAL BOX
DIM. (mm): L=604 P=322 H=1600

ART.	descrizione	€
VISUAL019	1 x FVB00201 1 x FVB00301 1 x FVB00401 1 x FVB100BAS0001	342,00



SCAFFALE CON 46 CASSETTI VISUAL BOX
DIM. (mm): L=604 P=322 H=1600

ART.	descrizione	€
VISUAL020	1 x FVB00201 1 x FVB00401 1 x FVB00501 1 x FVB100BAS0001	351,00



Scaffali composti da base e 3 telai da 500 mm di altezza sovrapposti tramite incastro brevettato.

H= 2000 mm



SCAFFALE CON 144 CASSETTI VISUAL BOX
DIM. (mm): L=604 P=322 H=2100

ART.	descrizione	€
VISUAL021	4 x FVB00101 1 x FVB100BAS0001	434,10

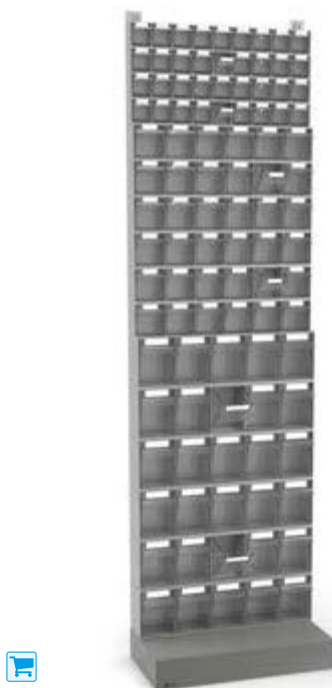

SCAFFALE CON 102 CASSETTI VISUAL BOX
DIM. (mm): L=604 P=322 H=2100

ART.	descrizione	€
VISUAL022	2 x FVB00101 2 x FVB00301 1 x FVB100BAS0001	435,90

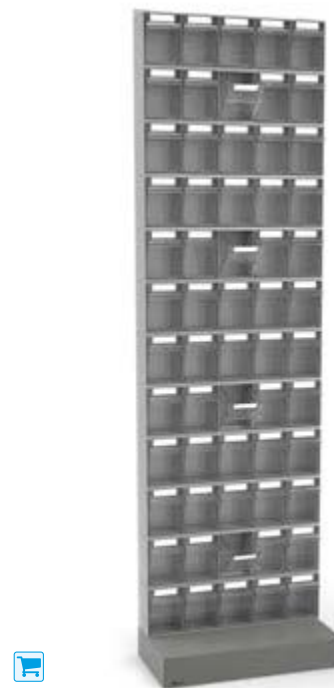

SCAFFALE CON 60 CASSETTI VISUAL BOX
DIM. (mm): L=604 P=322 H=2100

ART.	descrizione	€
VISUAL023	4 x FVB00301 1 x FVB100BAS0001	437,70



SCAFFALE CON 72 CASSETTI VISUAL BOX
DIM. (mm): L=604 P=322 H=2100

ART.	descrizione	€
VISUAL024	1 x FVB00201 1 x FVB00301 2 x FVB00401 1 x FVB100BAS0001	449,40



SCAFFALE CON 61 CASSETTI VISUAL BOX
DIM. (mm): L=604 P=322 H=2100

ART.	descrizione	€
VISUAL025	1 x FVB00201 1 x FVB00301 1 x FVB00401 1 x FVB00501 1 x FVB100BAS0001	451,20



Scaffali composti da base e 4 telai da 500 mm di altezza sovrapposti tramite incastro brevettato.

CLASSIC MAT

TAPPETI
SERIE PRO

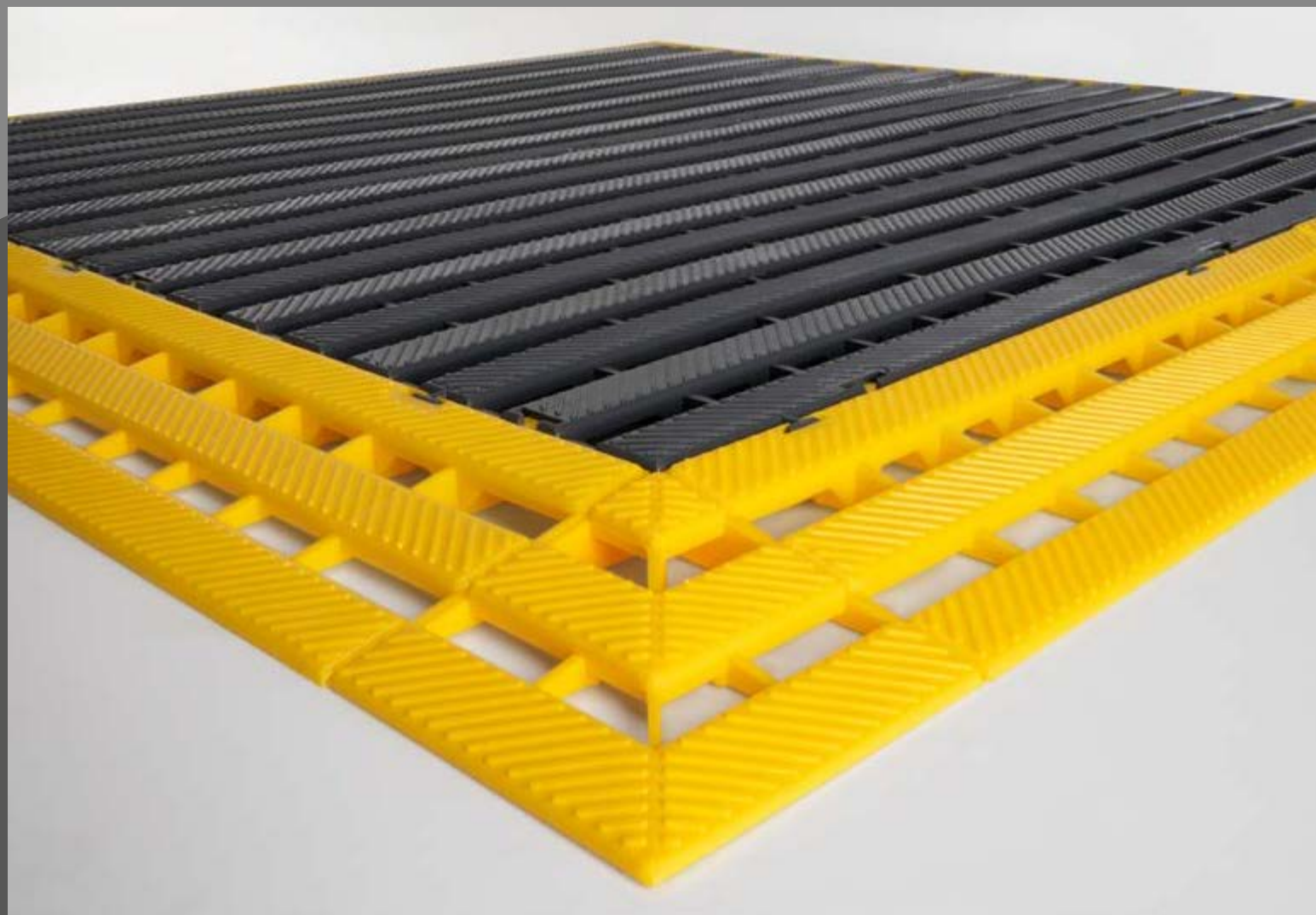

I tappeti MAT contribuiscono ad **incrementare l'efficienza e la sicurezza** sul luogo di lavoro. La particolare trama della superficie, infatti, aumenta l'attrito durante la camminata o il lavoro evitando possibili cadute o infortuni. L'aggiunta di **raccordi ed angoli** crea una rampa che riduce il pericolo di inciampo ed agevola la salita e discesa anche nel caso in cui siano impiegati arredi su ruote come carrelli o cassettiere.

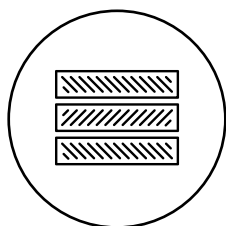

TRAMA
ANTISDRUCCIOLO

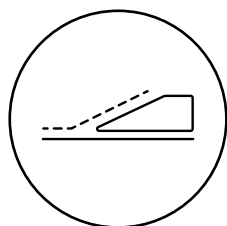

SALITA/DISCESA
SICURA

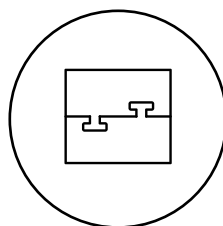

INCASTRO FACILE

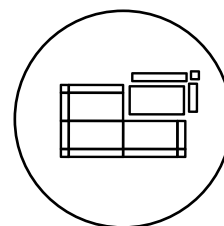

MODULARE

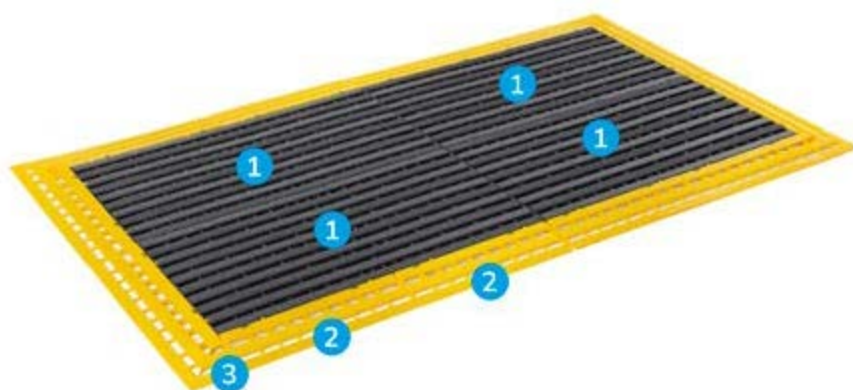

MAT

I tappeti antisdrucciolo sono caratterizzati da:

1. Tappeto antisdrucciolo
2. Raccordo per tappeto
3. Angolo per tappeto

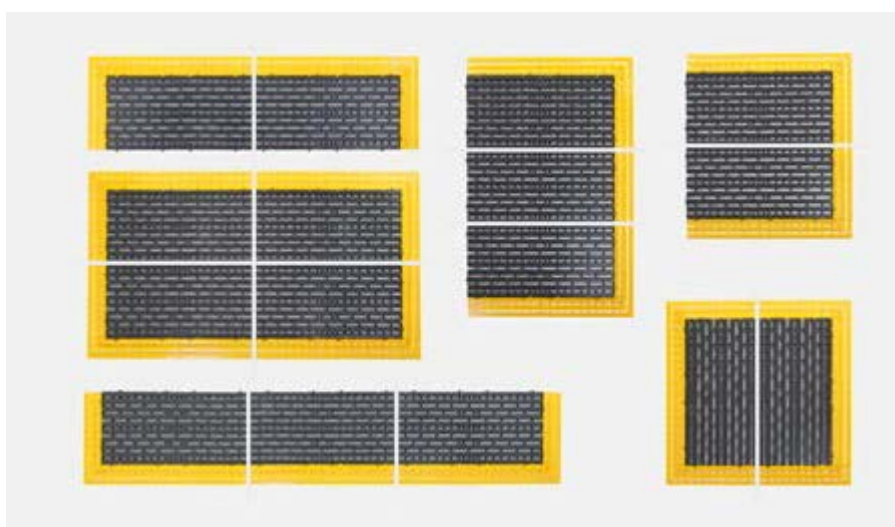



SISTEMA MODULARE

Ogni tappeto antisdrucciolo è dotato di appositi inserti lungo tutto il perimetro per garantire massima libertà nell'unione di più componenti. È possibile così ottenere tappeti di diverse forme e ampiezze, facili da adattare allo spazio a disposizione.





TAPPETO ANTISDRUCCILO IN POLIETILENE

ART.	multiplo d'ordine	L mm	P mm	H mm	colore	€
 FAXBRTA80400039	4	800	400	25		16,50





RACCORDO PER TAPPETO IN POLIETILENE

ART.	multiplo d'ordine	L mm	P mm	H mm	colore	€
 FAXBRRA40010005	12	400	110	25		3,90



ANGOLO PER TAPPETO IN POLIETILENE

ART.	multiplo d'ordine	L mm	P mm	H mm	colore	€
 FAXBRAN01010005	10	110	110	25		2,10

STEEL

CASSETTE, CONTENITORI E CONTAINERS IN METALLO SERIE PRO+



Le **cassette e i contenitori in metallo** hanno una struttura solida per poter trasportare e contenere minuteria e componenti pesanti. Fianchi e fondo, infatti, presentano apposite **nervature** che irrobustiscono l'intero contenitore e garantiscono **resistenza a usi intensivi, urti e carichi pesanti**. Steel presenta **cassette e contenitori a bocca di lupo** di dimensioni contenute per l'organizzazione di componentistica su postazioni di lavoro o in magazzino oppure **cazioni in metallo con fondo apribile o a bocca di lupo di grandi dimensioni** per la gestione degli scarti e dei semilavorati.

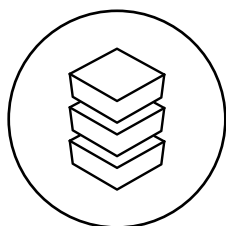

SOVRAPPONIBILE

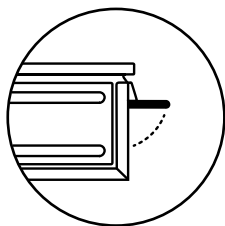

MANIGLIA BLOCCO
A 90°

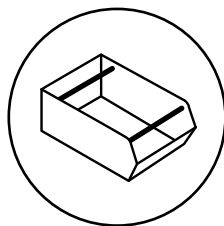

TRAVERSINO DI
SOLLEVAMENTO



ROBUSTI

STEEL

CASSETTE E CONTENITORI



272-3A2



272-3



272-4



272-4A5



272-5

ART.	multiplo d'ordine	mis.	dim. ingombro			dim. utili			L	RAL	€
			Lmm	Pmm	Hmm	Lmm	Pmm	Hmm			
 FLA33200A01	10	272-3A2	325	210	145	300	200	130	8,7	7000	22,80
 FLA41200A01	8	272-3	325	210	200	300	200	185	12	7000	24,00
 FLA65200A01	6	272-4	480	315	200	450	300	185	27	7000	27,30
 FLA73200A01	4	272-4A5	480	315	300	450	300	280	40,5	7000	44,40
 FLA89200A01	6	272-5	660	480	300	630	450	280	85	7000	67,50



CAPACITÀ



RAL 7000

STEEL

CASSETTE E CONTENITORI



1



2



3A2



4A2

ART.	multiplo d'ordine	mis.	dim. ingombro			dim. utili			L	RAL	€
			L mm	P mm	H mm	L mm	P mm	H mm			
FLS17000A01	20	1	105	165	75	95	140	65	1	7000	4,50
FLS25000A01	20	2	150	235	125	140	195	115	3,8	7000	9,30
FLS33000A01	10	3A2	210	350	145	195	300	135	9,4	7000	19,20
FLS57000A01	8	4A2	310	500	145	300	450	135	20	7000	29,70



3



3P4



4



4A5

ART.	multiplo d'ordine	mis.	dim. ingombro			dim. utili			L	RAL	€
			L mm	P mm	H mm	L mm	P mm	H mm			
FLS41000A01	8	3	210	350	200	200	300	185	12,5	7000	19,50
FLS49000A01	9	3P4	210	550	200	200	450	185	18	7000	27,30
FLS65000A01	6	4	310	510	200	300	450	185	28	7000	25,20
FLS73000A01	4	4A5	310	525	315	300	450	280	42	7000	40,50

TRAVERSINO DI SOLLEVAMENTO ABBINATO ALLA MANIGLIA BLOCCO A 90°



STEEL

CASSETTE E CONTENITORI



5P4



5



5P4



5

ART.	multiplo d'ordine	mis.	dim. ingombro			dim. utili			n. slitte	L	RAL	€
			L mm	P mm	H mm	L mm	P mm	H mm				
FLS81000A01	6	5P4	480	540	300	450	450	280	-	63	7000	54,30
FLS89000A01	6	5	480	725	295	450	630	280	-	88	7000	57,00
FLS81100A01	4	5P4	480	540	385	450	450	280	2	63	7000	81,00
FLS89100A01	4	5	480	725	385	450	630	280	2	88	7000	82,20



4



4A5



5P4



5

ART.	multiplo d'ordine	mis.	dim. ingombro			dim. utili			L	RAL	€
			L mm	P mm	H mm	L mm	P mm	H mm			
FLS65010A01	6	4	310	510	200	300	450	185	28	7000	33,60
FLS73010A01	4	4A5	310	525	315	300	450	280	42	7000	50,10
FLS81010A01	6	5P4	480	540	300	450	450	280	63	7000	66,60
FLS89010A01	6	5	480	725	295	450	630	280	88	7000	69,30

APPLICAZIONI SPECIALI

CONTENITORI CON DOPPIO TRAVERSINO



sistema di prelevamento con carrello elevatore

CONTENITORI CON SLITTA



sistema di prelevamento con carrello elevatore



CAPACITÀ



RAL 7000

STEEL

CONTENITORI FONDO APRIBILE



CONTAINER CON FONDO APRIBILE A RULLI

ART.	Lmm	Pmm	Hmm	KG	RAL	€
 FML01210001	1095	865	1265	2000	7000	785,70

CONTAINER CON FONDO APRIBILE A RULLI

ART.	Lmm	Pmm	Hmm	KG	RAL	€
 FML01110001	1095	865	915	2000	7000	680,40

CONTAINERS CON FONDO APRIBILE A RULLI

Sollevati con carrello elevatore tramite le quattro maniglie saldate al bordo superiore, consentono di scaricare il materiale per mezzo del fondo apribile a rulli (apertura dell'87%). L'apertura avviene in modo facile e sicuro tramite la leva posta sul lato da 800 mm, mentre la chiusura mediante un particolare dispositivo composto di leve e rulli d'acciaio.





STEEL

CONTENITORI BOCCA DI LUPO



CONTAINER A BOCCA DI LUPO

ART.	multiplo d'ordine	L mm	P mm	H mm		RAL	€
 FML05100A01	3	830	680	600	1000	7000	183,90



PORTATA



RAL 7000

SYSTEM ST

SCAFFALI
SERIE PRO



SYSTEM ST

System ST è una scaffalatura metallica facile da montare, solida e ad alta portata. La **struttura modulare** consente di creare numerose soluzioni con larghezze variabili e differenti configurazioni. La versione base dello **scaffale per magazzino** con ripiani fessurati, divisori e separatori, infatti, può ampliarsi e trasformarsi fino a diventare uno **scaffale porta pneumatici**, uno **scaffale per magazzino dinamico**, con ripiani inclinati o telai inclinabili con binari e rulli, o uno **scaffale porta minuteria con contenitori**.



1. Montante fessurato passo 25 mm per fiancata
2. Piano fessurato (portata fino a 300 kg)
3. Parete posteriore (su richiesta)
4. Parete laterale (su richiesta)
5. Barra appendi abiti (su richiesta)
6. Cassetto ad estrazione semplice (portata 50 kg)
Cassetto ad estrazione telescopica (portata 100 kg)
7. Zoccolo (su richiesta)
8. Coppia porte a battente con chiusura a cilindro e 2 chiavi (su richiesta)
9. Parete centrale (su richiesta)
10. Traverso di collegamento per fiancate
11. Corrente L=2000 mm
Corrente L=2600 mm (su richiesta)
12. Traverso di collegamento tra scaffali (su richiesta)
13. Piedino/tappo in plastica
14. Divisori verticali (su richiesta)
15. Separatori H=100 mm
16. Set bandinelle con divisori trapezoidali
17. Separatori H=40 mm
18. Innesto in plastica per montanti
19. Coppia supporti porta pneumatici
20. Telaio ad inclinazione variabile con binari a rulli spostabili in lunghezza
21. Coppia staffe per piano inclinato (da 5° a 30° circa)
22. Bordo fermacasse
23. Piano di tenuta
24. Slitte per contenitori
25. Fermo antiribaltamento per contenitori

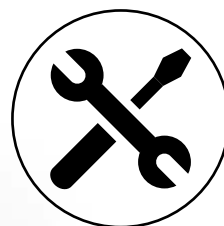

**FACILI DA
MONTARE**

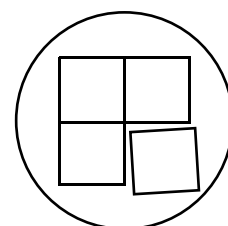

COMPONIBILI

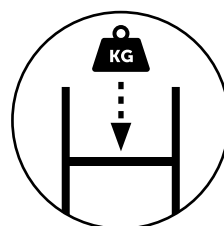

**PORTATA PIANI
FINO A 300 KG**

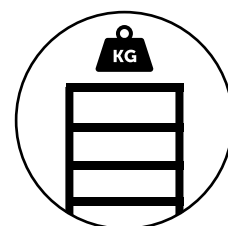

**PORTATA
CAMPATA 2300 KG**

SYSTEM ST



SYSTEM ST



SYSTEM ST



SCAFFALE CON 5 PIANI

	ART.	L mm	P mm	H mm	 per piano	finitura	€
 A	ST1001	1057	321	2011	120	Zincato	190,20
 A	ST1002	1057	421	2011	120	Zincato	195,90
 A	ST1003	1057	521	2011	120	Zincato	205,80
 A	ST1004	1057	621	2011	120	Zincato	235,80
 A	ST1005	1057	821	2011	120	Zincato	262,80
 B	ST1006	1028	321	2011	120	Zincato	134,10
 B	ST1007	1028	421	2011	120	Zincato	140,40
 B	ST1008	1028	521	2011	120	Zincato	149,40
 B	ST1009	1028	621	2011	120	Zincato	178,20
 B	ST1010	1028	821	2011	120	Zincato	203,70



SCAFFALE CON 10 PIANI

	ART.	L mm	P mm	H mm	 per piano	finitura	€
	ST2001	2071	521	2011	120	Zincato	355,20

Composto da:

qtà	descrizione
3	Kit 4 montanti
2	Kit 5 piani fessurati
3	Kit 3 traversini
3	Crociera di irrigidimento
3	Kit 2 piedini in polipropilene
3	Kit 2 innesti

[CONFIGURE](#) 

PATENTED*

SYSTEM ST

COMPONENTI



KIT 5 PIANI FESSURATI

ART.	L mm	P mm	H mm	KG	finitura	€
FST1030S199	1000	300	35	120	Zincato	78,00
FST1040S199	1000	400	35	120	Zincato	84,90
FST1050S199	1000	500	35	120	Zincato	93,00
FST1060S199	1000	600	35	120	Zincato	120,60
FST1080S199	1000	800	35	120	Zincato	144,60

PIANO FESSURATO

ART.	L mm	P mm	H mm	KG	finitura	€
FST1030S099	1000	300	35	120	Zincato	26,10
FST1040S099	1000	400	35	120	Zincato	27,60
FST1050S099	1000	500	35	120	Zincato	29,40
FST1060S099	1000	600	35	120	Zincato	30,90
FST1080S099	1000	800	35	120	Zincato	36,30

RINFORZO PER PIANO FESSURATO

ART.	L mm	P mm	H mm	multiplo d'ordine	finitura	€
FST1310S199	998	50	33	5	Zincato	6,30

Un rinforzo aumenta la portata del piano fessurato a 300 kg. Non può essere installato sui piani fessurati con profondità 300 mm.



CASSETTI AD ESTRAZIONE SEMPLICE 54X27 EH

ART.	dim. utili			h frontale cassetto	KG		RAL	€
	L mm	P mm	H mm					
ST1011	908	449	85	100	50	88%	7035	90,00
ST1012	908	449	85	100	50	88%	5012	90,00
ST1013	908	449	85	100	50	88%	7016	107,70

Si possono inserire massimo 6 cassette per ogni campata e la massima altezza di inserimento è di 950 mm.



CASSETTI AD ESTRAZIONE TELESCOPICA 54X27 EH

ART.	dim. utili			h frontale cassetto	KG		RAL	€
	L mm	P mm	H mm					
ST1014	908	449	85	100	100	100%	7035	115,80
ST1015	908	449	85	100	100	100%	5012	115,80
ST1016	908	449	85	100	100	100%	7016	132,90
ST1017	908	449	135	150	100	100%	7035	129,00
ST1018	908	449	135	150	100	100%	5012	129,00
ST1019	908	449	135	150	100	100%	7016	141,30

Si possono inserire massimo 3 cassette per ogni campata (oppure 6 se si riduce la portata a 50 kg) e la massima altezza di inserimento è di 950 mm.



COPIA STAFFE PER PIANO INCLINATO

ART.	L mm	P mm	H mm	finitura	€
FST1200S099	19	210	64	Zincato	11,70



PORTATA



RAL 5012



RAL 7016



RAL 7035







ZINCATO

SYSTEM ST

COMPONENTI



COPPIA BANDINELLE CON DIVISORI TRAPEZOIDALI

ART.	L mm	P mm	H mm	finitura	€
 ST1061	999	301	200	Zincato	30,60
 ST1062	999	401	200	Zincato	31,50
 ST1063	999	501	200	Zincato	32,40
 ST1064	999	601	200	Zincato	33,30







COPPIA DIVISORI TRAPEZOIDALI ZINCATI AGGIUNTIVI

ART.	L mm	P mm	H mm	finitura	€
 FST9630S099	16	293	187	Zincato	9,30
 FST9640S099	16	393	187	Zincato	10,20
 FST9650S099	16	493	187	Zincato	11,10
 FST9660S099	16	593	187	Zincato	12,00







KIT 4 SEPARATORI ZINCATI PER PIANI

ART.	L mm	P mm	H mm	finitura	€
 FST9230S199	39	297	100	Zincato	16,20
 FST9240S199	39	397	100	Zincato	17,70
 FST9250S199	39	497	100	Zincato	17,10
 FST9260S199	39	597	100	Zincato	18,90
 FST9280S199	39	797	100	Zincato	21,30



KIT 4 SEPARATORI ZINCATI PER PIANI

ART.	L mm	P mm	H mm	finitura	€
 FST9330S199	39	297	40	Zincato	11,70
 FST9340S199	39	397	40	Zincato	12,60
 FST9350S199	39	497	40	Zincato	13,80
 FST9360S199	39	597	40	Zincato	15,00
 FST9380S199	39	797	40	Zincato	17,10



STAFFE FISSAGGIO A MURO

ART.	L mm	P mm	H mm	finitura	€
 FST0710S199	24	20	79	Zincato	5,40



SYSTEM ST

COMPONENTI



COPPIA PIEDINI IN ACCIAIO

ART.	L mm	P mm	H mm	€
FVT01450000	65	68	18	1,50



COPPIA PIEDINI / TAPPI IN PLASTICA

ART.	L mm	P mm	H mm	€
FVT02590000	42	65	55	2,40



KIT 4 PIASTRE PER RUOTE

ART.	L mm	P mm	H mm	colore	€
FST3600S139	105	104	52	7016	31,80



BORDO FERMACASSE PER PIANO FESSURATO

ART.	L mm	P mm	H mm	finitura	€
FST1410S099	972	10	60	Zincato	11,10

KIT 5 BORDI FERMACASSE PER PIANO FESSURATO

ART.	L mm	P mm	H mm	finitura	€
FST1410S199	972	10	60	Zincato	45,60



KIT RUOTE

ART.	Ø mm	KG set ruote	H mm	materiale			€
FKRD1002107	100	225	128	Gomma standard	2	2	44,10
FKRB1252107	125	300	155	Gomma standard	2	2	48,90
FKRU1252101	125	300	155	Gomma antiraccia sintetica	2	2	53,40
FKRS1252101	125	750	155	Gomma elastica	2	2	85,20



PORTATA



RUOTA FISSA



RUOTA GIREVOLE CON FRENO





ZINCATO

SYSTEM ST



SCAFFALE CON 6 PIANI

ART.	L mm	P mm	H mm	KG per piano	cassetti		finitura	€
					n.	KG		
 A ST1020	1057	521	2011	120	1	50	Zincato	447,00
 B ST1021	1028	521	2011	120	1	50	Zincato	390,60

Completo di 4 separatori, 2 coppie bandinelle, 4 divisori trapezoidali, 1 cassetto ad estrazione semplice



SCAFFALE CON 6 PIANI E 9 CONTENITORI PICKING BOX AIR MIS. 4A5

ART.	L mm	P mm	H mm	KG per piano	cassetti		finitura	€
					n.	KG		
 A ST1022	1057	521	2011	120	1	50	Zincato	514,50
 B ST1023	1028	521	2011	120	1	50	Zincato	458,10

Completo di 4 separatori, 1 coppia bandinelle, 4 divisori trapezoidali, 1 cassetto ad estrazione semplice

SCAFFALE CON 6 PIANI SENZA CONTENITORI





ART.	L mm	P mm	H mm	KG per piano	cassetti		finitura	€
					n.	KG		
 A ST1024	1057	521	2011	120	1	50	Zincato	414,60
 B ST1025	1028	521	2011	120	1	50	Zincato	358,20

Completo di 4 separatori, 1 coppia bandinelle, 4 divisori trapezoidali, 1 cassetto ad estrazione semplice

SYSTEM ST



SCAFFALE CON 6 PIANI

	ART.	L mm	P mm	H mm	 per piano	finitura	€
 A	ST1026	1057	321	2011	120	Zincato	296,10
 A	ST1027	1057	421	2011	120	Zincato	306,90
 A	ST1028	1057	521	2011	120	Zincato	322,20
 A	ST1029	1057	621	2011	120	Zincato	357,30

Completo di 2 coppie bandinelle, 4 divisori trapezoidali

 B	ST1030	1028	321	2011	120	Zincato	240,00
 B	ST1031	1028	421	2011	120	Zincato	251,40
 B	ST1032	1028	521	2011	120	Zincato	265,80
 B	ST1033	1028	621	2011	120	Zincato	299,70

Completo di 2 coppie bandinelle, 4 divisori trapezoidali



 PORTATA

 ZINCATO

SYSTEM ST



SCAFFALE PORTA PNEUMATICI

ART.	L mm	P mm	H mm	n. supporti	per supporto	finitura	€
A ST1034	1057	421	2016	6	50	Zincato	171,00
B ST1035	1028	421	2016	6	50	Zincato	123,30

SUPPORTO PORTA PNEUMATICI



ART.	multiplo d'ordine	L mm	P mm	H mm	per supporto	finitura	€
FST9580S199	2	1000	33	98	50	Zincato	12,60



SCAFFALE PORTA PNEUMATICI

ART.	L mm	P mm	H mm	n. supporti	per supporto	finitura	€
ST2002	2071	421	2016	12	50	Zincato	294,30

SYSTEM ST



SCAFFALE CON 6 PIANI E 6 CORRENTI

	ART.	L mm	P mm	H mm	 per coppia corrente	finitura	€
 A	ST2003	2065	321	2016	250	Zincato	449,10
 A	ST2004	2065	421	2016	250	Zincato	456,30
 A	ST2005	2065	521	2016	250	Zincato	468,00
 A	ST2006	2065	621	2016	250	Zincato	499,50
 A	ST2007	2065	821	2016	250	Zincato	531,90
 B	ST2008	2036	321	2016	250	Zincato	400,80
 B	ST2009	2036	421	2016	250	Zincato	408,60
 B	ST2010	2036	521	2016	250	Zincato	419,40
 B	ST2011	2036	621	2016	250	Zincato	449,70
 B	ST2012	2036	821	2016	250	Zincato	480,60



PORTATA



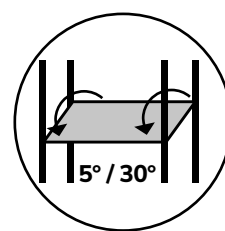

ZINCATO

SYSTEM ST



SCAFFALE CON 6 PIANI INCLINATI

ART.	L mm	P mm	H mm	 per piano	finitura	€
 ST2602	2671	321	2016	100	Zincato	433,20
 ST2603	2671	421	2016	100	Zincato	441,90
 ST2604	2671	521	2016	100	Zincato	456,30
 ST2605	2671	621	2016	100	Zincato	501,00
 ST2606	2671	821	2016	100	Zincato	534,90

Completo di bordi fermacasse e coppia staffe per piani inclinati 5°/30°



SYSTEM ST



Predisposto per ruote e staffe vedi pag. 83

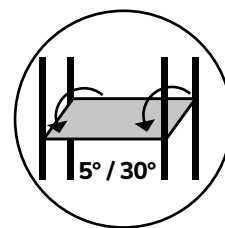

SCAFFALE CON 7 PIANI INCLINATI

	ART.	L mm	P mm	H mm	n. kit 4 separatori	finitura	€
 A	ST1036	1057	521	2016	10	Zincato	654,30
 A	ST1037	1057	621	2016	10	Zincato	762,30
 A	ST1038	1057	821	2016	10	Zincato	821,10
 B	ST1039	1028	521	2016	10	Zincato	605,70
 B	ST1040	1028	621	2016	10	Zincato	712,50
 B	ST1041	1028	821	2016	10	Zincato	769,80

Completo di bordi fermacasse e coppia staffe per piani inclinati 5°/30°

 Piani con profondità 500 mm portata 120 kg. Piani con profondità 600 e 800 mm portata 300 kg.



PORTATA



ZINCATO

SYSTEM ST



A



SCAFFALE CON 4 TELAI INCLINABILI

ART.	L mm	P mm	H mm	KG per telaio	KG per binario al metro lineare	n. binari con rulli	finitura	€
A ST1101	1100	1509	2009	200	4	32	Zincato	1382,40
B ST1102	1100	1009	2009	200	4	32	Zincato	1239,60
C ST1401	1400	1009	2009	200	4	32	Zincato	1317,60
D ST1402	1400	1509	2009	200	4	32	Zincato	1435,20



B



C







D

SYSTEM ST



SCAFFALE CON 4 TELAI INCLINABILI CON RUOTE





ART.	L mm	P mm	H mm	KG per telaio	KG per binario al metro lineare	n. binari con rulli	ruote			finitura	€
							KG set ruote				
 A ST1103	1118	1009	2164	200	4	32	750	2	2	Zincato	1353,60
 B ST1403	1418	1009	2164	200	4	32	750	2	2	Zincato	1431,60





- 
PORTATA
- 
RUOTA FISSA
- 
RUOTA GIREVOLE CON FRENO
- 
ZINCATO



SCAFFALE CON 5 PIANI E 12 CONTENITORI PICKING BOX AIR MIS. 4





ART.	L mm	P mm	H mm	contenitori					per piano	finitura	€
				nr	mis.	kg	L	colore			
 A ST1045	1057	521	1111	12	4	39	28		120	Zincato	267,00
 B ST1046	1028	521	1111	12	4	39	28		120	Zincato	235,50

SCAFFALE CON 5 PIANI SENZA CONTENITORI MIS. 4



ART.	L mm	P mm	H mm	per piano	finitura	€
 A ST1047	1057	521	1111	120	Zincato	166,20
 B ST1048	1028	521	1111	120	Zincato	134,70



SCAFFALE CON 8 PIANI E 24 CONTENITORI PICKING BOX AIR MIS. 4













ART.	L mm	P mm	H mm	contenitori					per piano	finitura	€
				nr	mis.	KG	L	colore			
 A ST1049	1057	521	2056	24	4	39	28		120	Zincato	500,40
 B ST1050	1028	521	2056	24	4	39	28		120	Zincato	441,60

SCAFFALE CON 8 PIANI SENZA CONTENITORI MIS. 4

ART.	L mm	P mm	H mm	per piano	finitura	€
 A ST1051	1057	521	2016	120	Zincato	298,80
 B ST1052	1028	521	2016	120	Zincato	240,00

CONTENITORE CON FONDO RINFORZATO



ART.	multiplo d'ordine	mis.	dim. ingombro			L	colore	€
			L mm	P mm	H mm			
 FPB0004R051LQ	12	4	333	508	203	28		8,40
 FPB0004R05139	12	4	333	508	203	28		8,40
 FPB0004R05132	12	4	333	508	203	28		8,40
 FPB0004R0511Z	12	4	333	508	203	28		8,40
 FPB0004R0512Y	12	4	333	508	203	28		8,40
 FPB0004R0514Q	12	4	333	508	203	28		8,40



PORTATA



CAPACITÀ



ZINCATO



SCAFFALE CON 6 PIANI E 18 CONTENITORI PICKING BOX AIR MIS. 4A5

ART.	L mm	P mm	H mm	contenitori					per piano	finitura	€
				nr	mis.	KG	L	colore			
A ST1053	1057	521	2131	18	4A5	39	42		120	Zincato	439,80
B ST1054	1028	521	2131	18	4A5	39	42		120	Zincato	381,00

SCAFFALE CON 6 PIANI SENZA CONTENITORI MIS. 4A5

ART.	L mm	P mm	H mm	per piano	finitura	€
A ST1055	1057	521	2016	120	Zincato	240,00
B ST1056	1028	521	2016	120	Zincato	181,20





CONTENITORE CON FONDO RINFORZATO





ART.	multiplo d'ordine	mis.	dim. ingombro			L	colore	€
			L mm	P mm	H mm			
FPB04A5R051LQ	9	4A5	333	507	304	42		11,10
FPB04A5R05139	9	4A5	333	507	304	42		11,10
FPB04A5R05132	9	4A5	333	507	304	42		11,10
FPB04A5R0511Z	9	4A5	333	507	304	42		11,10
FPB04A5R0512Y	9	4A5	333	507	304	42		11,10
FPB04A5R0514Q	9	4A5	333	507	304	42		11,10



SCAFFALE CON 7 PIANI E 21 CONTENITORI PICKING BOX AIR MIS. 4/4A5

ART.	L mm	P mm	H mm	contenitori					per piano	finitura	€
				nr	mis.	KG	L	colore			
 A ST1057	1057	521	2111	9+12	4A5/4	39/39	42/28		120	Zincato	470,10
 B ST1058	1028	521	2111	9+12	4A5/4	39/39	42/28		120	Zincato	411,30

SCAFFALE CON 7 PIANI SENZA CONTENITORI MIS. 4/4A5













ART.	L mm	P mm	H mm	per piano	finitura	€
 A ST1059	1057	521	2016	120	Zincato	269,40
 B ST1060	1028	521	2016	120	Zincato	210,60

CONTENITORE CON FONDO RINFORZATO



4



ART.	multiplo d'ordine	mis.	dim. ingombro			L	colore	€
			L mm	P mm	H mm			
 FPB0004R051LQ	12	4	333	508	203	28		8,40
 FPB0004R05139	12	4	333	508	203	28		8,40
 FPB0004R05132	12	4	333	508	203	28		8,40
 FPB0004R0511Z	12	4	333	508	203	28		8,40
 FPB0004R0512Y	12	4	333	508	203	28		8,40
 FPB0004R0514Q	12	4	333	508	203	28		8,40



PORTATA



CAPACITÀ



ZINCATO

SYSTEM ST

P= 300 mm

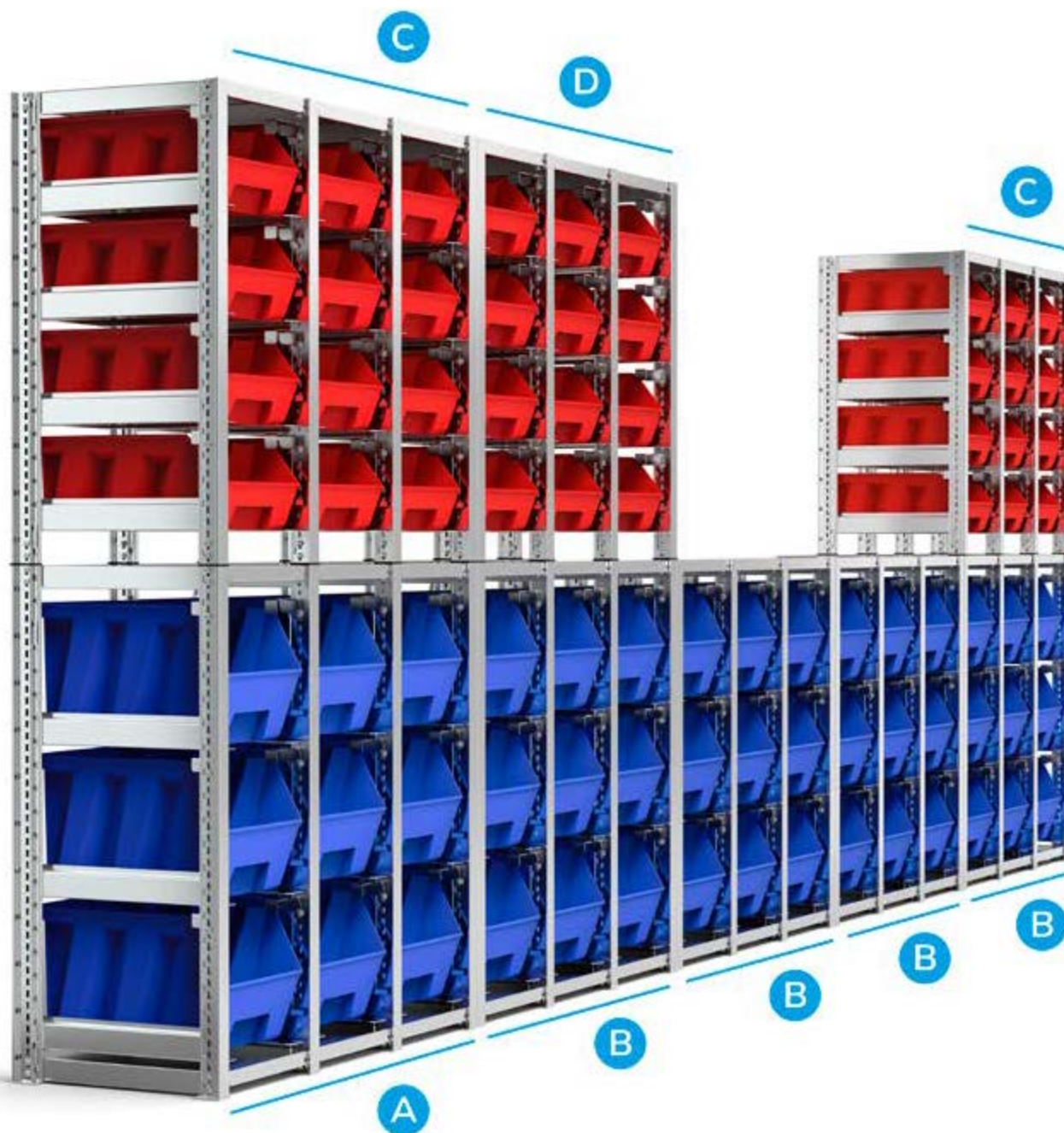

SYSTEM ST

P= 300 mm

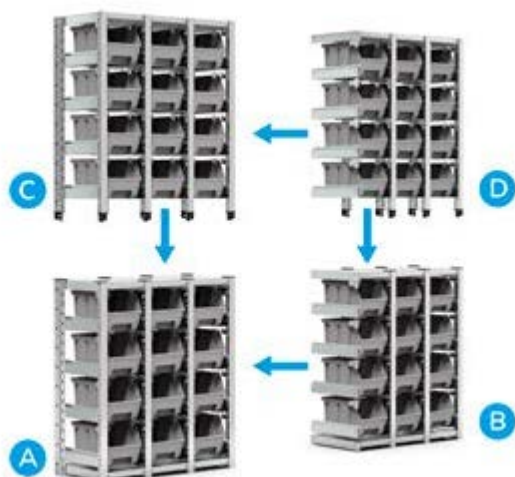

Completo di fermo antiribaltamento di serie



SCAFFALE CON 12 CONTENITORI PICKING BOX AIR MIS. 3

ART.	L mm	P mm	H mm	n. slitte	contenitori					coppia slitte	finitura	€
					nr	mis.	KG	L	colore			
A ST0901	909	421	1009	12 + 12	12	3	22	12,5	■	50	Zincato	529,50
B ST0902	859	421	1009	12 + 12	12	3	22	12,5	■	50	Zincato	512,10
C ST0903	866	421	1048	12 + 12	12	3	22	12,5	■	50	Zincato	488,70
D ST0904	838	421	1048	12 + 12	12	3	22	12,5	■	50	Zincato	470,70

SCAFFALE VUOTO PER CONTENITORI MIS. 3

ART.	L mm	P mm	H mm	n. slitte	KG	finitura	€
					coppia slitte		
A ST0905	909	421	1009	12 + 12	50	Zincato	471,90
B ST0906	859	421	1009	12 + 12	50	Zincato	454,50
C ST0907	866	421	1048	12 + 12	50	Zincato	431,10
D ST0908	838	421	1048	12 + 12	50	Zincato	413,10

CONTENITORE CON FONDO RINFORZATO



ART.	multiplo d'ordine	mis.	dim. ingombro			L	colore	€
			L mm	P mm	H mm			
FPB0003R051LQ	12	3	224	354	203	12,5	■	4,80
FPB0003R05139	12	3	224	354	203	12,5	■	4,80
FPB0003R05132	12	3	224	354	203	12,5	■	4,80
FPB0003R0511Z	12	3	224	354	203	12,5	■	4,80
FPB0003R0512Y	12	3	224	354	203	12,5	■	4,80
FPB0003R0514Q	12	3	224	354	203	12,5	■	4,80

CONTENITORE IN ACCIAIO - DIM. INGOMBRO (mm): L=210 P=350 H=200



ART.	multiplo d'ordine	mis.	dim. utili			L	colore	€
			L mm	P mm	H mm			
FLS41000A01	8	3	200	300	185	12,5	7000	19,50



PORTATA



CAPACITÀ



RAL 7000



ZINCATO

SYSTEM ST

P= 500 mm



Completo di fermo antiribaltamento di serie



SCAFFALE CON 12 CONTENITORI PICKING BOX AIR MIS. 4

ART.	L mm	P mm	H mm	n. slitte	contenitori					coppia slitte	finitura	€
					nr	mis.	KG	L	colore			
A ST1201	1209	521	1009	12 + 12	12	4	39	28	■	50	Zincato	600,60
B ST1202	1159	521	1009	12 + 12	12	4	39	28	■	50	Zincato	583,20
C ST1203	1166	521	1048	12 + 12	12	4	39	28	■	50	Zincato	553,50
D ST1204	1138	521	1048	12 + 12	12	4	39	28	■	50	Zincato	535,50

SCAFFALE VUOTO PER CONTENITORI MIS. 4

ART.	L mm	P mm	H mm	n. slitte	KG	finitura	€
					coppia slitte		
A ST1205	1209	521	1009	12 + 12	50	Zincato	499,80
B ST1206	1159	521	1009	12 + 12	50	Zincato	482,40
C ST1207	1166	521	1048	12 + 12	50	Zincato	452,70
D ST1208	1138	521	1048	12 + 12	50	Zincato	434,70

CONTENITORE CON FONDO RINFORZATO



ART.	multiplo d'ordine	mis.	dim. ingombro			L	colore	€
			L mm	P mm	H mm			
FPB0004R051LQ	12	4	333	508	203	28	■	8,40
FPB0004R05139	12	4	333	508	203	28	■	8,40
FPB0004R05132	12	4	333	508	203	28	■	8,40
FPB0004R0511Z	12	4	333	508	203	28	■	8,40
FPB0004R0512Y	12	4	333	508	203	28	■	8,40
FPB0004R0514Q	12	4	333	508	203	28	■	8,40

CONTENITORE IN ACCIAIO - DIM. INGOMBRO (mm): L=310 P=510 H=200



ART.	multiplo d'ordine	mis.	dim. utili			L	colore	€
			L mm	P mm	H mm			
FLS65000A01	6	4	300	450	185	28	7000	25,20

SYSTEM ST

P= 500 mm

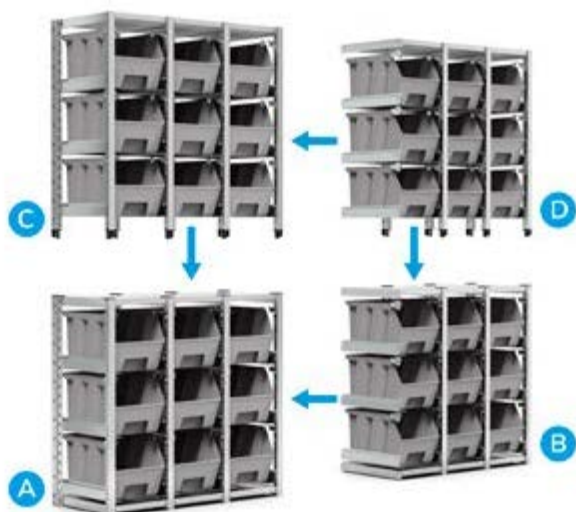

Completo di fermo antiribaltamento di serie



SCAFFALE CON 9 CONTENITORI PICKING BOX AIR MIS. 4A5

ART.	L mm	P mm	H mm	n. slitte	contenitori					coppia slitte	finitura	€
					nr	mis.	KG	L	colore			
A ST1209	1209	521	1109	9+9	9	4A5	39	42	■	50	Zincato	545,70
B ST1210	1159	521	1109	9+9	9	4A5	39	42	■	50	Zincato	521,40
C ST1211	1166	521	1148	9+9	9	4A5	39	42	■	50	Zincato	498,60
D ST1212	1138	521	1148	9+9	9	4A5	39	42	■	50	Zincato	473,70

SCAFFALE VUOTO PER CONTENITORI MIS. 4A5

ART.	L mm	P mm	H mm	n. slitte	KG	finitura	€
					coppia slitte		
A ST1213	1209	521	1109	9+9	50	Zincato	445,80
B ST1214	1159	521	1109	9+9	50	Zincato	421,50
C ST1215	1166	521	1148	9+9	50	Zincato	398,70
D ST1216	1138	521	1148	9+9	50	Zincato	373,80

CONTENITORE CON FONDO RINFORZATO



4A5



ART.	multiplo d'ordine	mis.	dim. ingombro			L	colore	€
			L mm	P mm	H mm			
FPB04A5R051LQ	9	4A5	333	507	304	42	■	11,10
FPB04A5R05139	9	4A5	333	507	304	42	■	11,10
FPB04A5R05132	9	4A5	333	507	304	42	■	11,10
FPB04A5R0511Z	9	4A5	333	507	304	42	■	11,10
FPB04A5R0512Y	9	4A5	333	507	304	42	■	11,10
FPB04A5R0514Q	9	4A5	333	507	304	42	■	11,10

CONTENITORE IN ACCIAIO - DIM. INGOMBRO (mm): L=310 P=525 H=315



ART.	multiplo d'ordine	mis.	dim. utili			L	colore	€
			L mm	P mm	H mm			
FLS73000A01	4	4A5	300	450	280	42	7000	40,50



PORTATA



CAPACITÀ



RAL 7000



ZINCATO

STORAGE DOMINO

SCAFFALI SERIE START



Gli **scaffali monoblocco porta contenitori** Storage Domino presentano una **struttura alveolare** per la creazione di magazzini modulari in cui organizzare contenitori a bocca di lupo in ferro o polipropilene. È possibile, infatti, **sovrapporli** in tutta sicurezza per creare soluzioni che si sviluppano in altezza e in larghezza in base agli spazi a disposizione. L'estrazione dei contenitori è rapida e sicura: un apposito gancio installato nella parte anteriore delle guide impedisce la fuoriuscita totale e accidentale del contenitore.

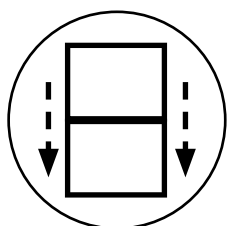

SOVRAPPONIBILI

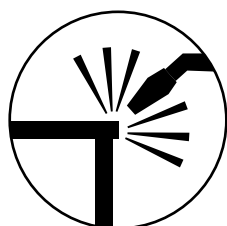

STRUTTURA
SALDATA



PORTATA MODULO
FINO A 1600 KG

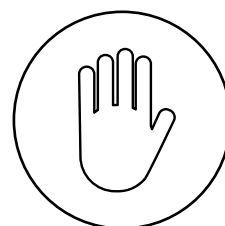

FERMO ANTICADUTA

STORAGE DOMINO



SCAFFALE CON 16 PICKING BOX CLASSIC MIS. 3

ART.	L mm	P mm	H mm	RAL	€
 FED30440301	1025	355	885	7000	380,40

Composto da:

qtà	descrizione
1	Scaffale a 16 posti per contenitori mis. 3
16	Contenitore in polipropilene Picking Box Classic mis. 3

SOVRAPPONIBILITÀ



n. telai sovrapposti	 di ogni telaio	 di ogni box
2	960	60
3	640	40



SCAFFALE CON 20 PICKING BOX CLASSIC MIS. 4

ART.	L mm	P mm	H mm	RAL	€
 FED40540301	1765	500	885	7000	571,50

Composto da:

qtà	descrizione
1	Scaffale a 20 posti per contenitori mis. 4
20	Contenitore in polipropilene Picking Box Classic mis. 4

SOVRAPPONIBILITÀ

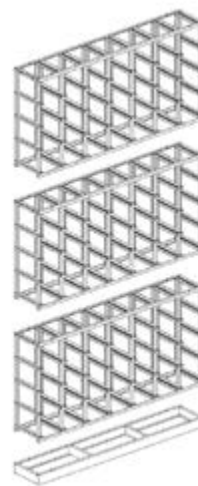

n. telai sovrapposti	 di ogni telaio	 di ogni box
3	1600	80



PORTATA



RAL7000

STORAGE DOMINO



SCAFFALE CON 16 CONTENITORI MIS. 3

ART.	L mm	P mm	H mm	RAL	€
 FED30440201	1025	355	885	7000	517,50

Composto da:

qtà	descrizione
1	Scaffale a 16 posti per contenitori mis. 3
16	Contenitore in metallo mis. 3

[CONFIGURE](#) 



SCAFFALE CON 20 CONTENITORI MIS. 4

ART.	L mm	P mm	H mm	RAL	€
 FED40540201	1765	500	885	7000	801,60

Composto da:

qtà	descrizione
1	Scaffale a 20 posti per contenitori mis. 4
20	Contenitore in metallo mis. 4

[CONFIGURE](#) 

SOVRAPPONIBILITÀ



n. telai sovrapposti	 di ogni telaio	 di ogni box
2	960	60
3	640	40

SOVRAPPONIBILITÀ

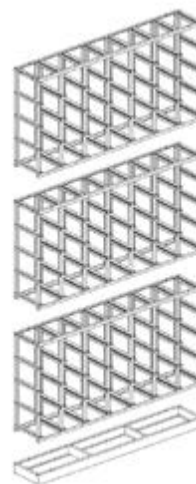

n. telai sovrapposti	 di ogni telaio	 di ogni box
3	1600	80

STORAGE DOMINO

COMPONENTI



SCAFFALE VUOTO

ART.	L mm	P mm	H mm	RAL	€
 FED30440A01	1025	310	885	7000	265,20

[CONFIGURE](#) 



SCAFFALE VUOTO

ART.	L mm	P mm	H mm	RAL	€
 FED40540A01	1765	460	885	7000	331,20

[CONFIGURE](#) 



COPERCHIO PARAPOLVERE

ART.	L mm	P mm	H mm	RAL	€
 FED90340001	1020	315	20	7000	27,00



COPERCHIO PARAPOLVERE

ART.	L mm	P mm	H mm	RAL	€
 FED90450001	1765	465	20	7000	38,40



ZOCOLO DI APPOGGIO

ART.	L mm	P mm	H mm	RAL	€
 FED92340001	1020	313	85	7000	51,00



ZOCOLO DI APPOGGIO

ART.	L mm	P mm	H mm	RAL	€
 FED92450001	1765	463	85	7000	74,70



PORTATA



RAL 7000

WORK

BANCHI DA LAVORO SERIE START

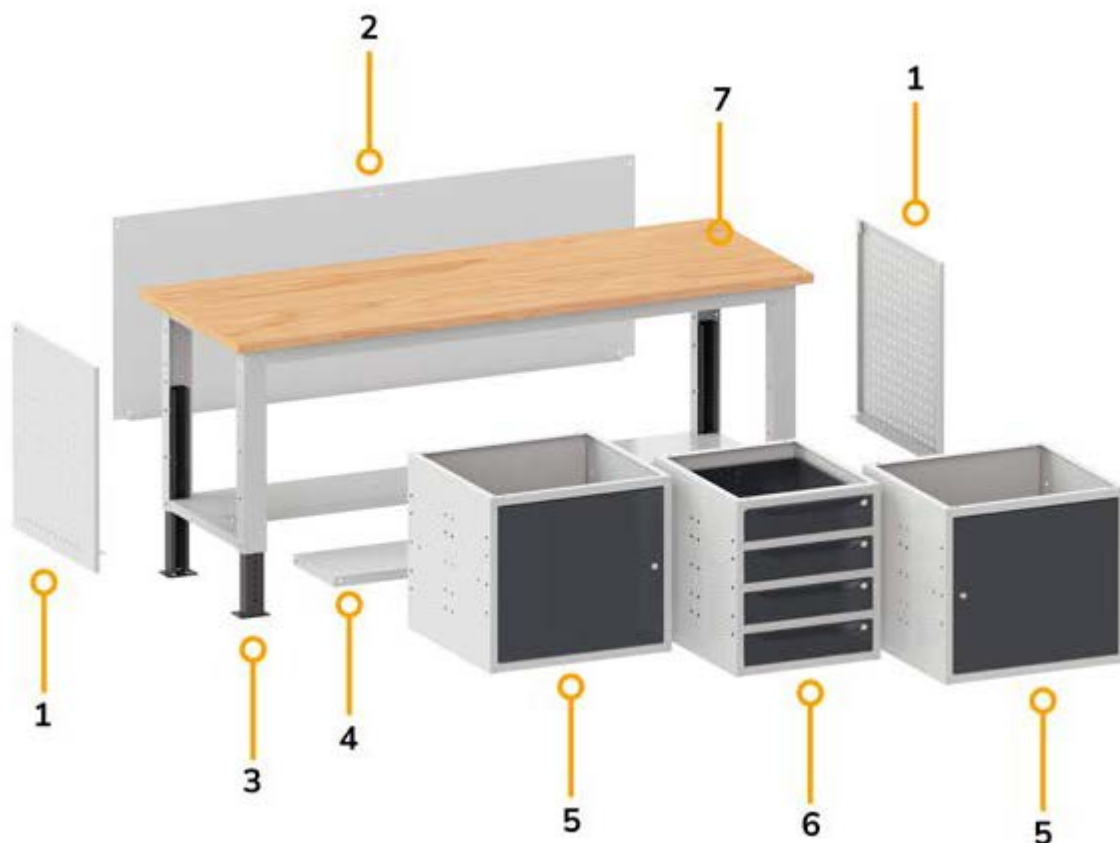

1. Pannello forato laterale
2. Chiusura posteriore
3. Gambe regolabili
4. Semipiano aggiuntivo

5. Armadio con porta
6. Armadio a 4 cassetti
7. Piano in Multiplex

I banchi della serie Work sono **soluzioni flessibili** e facilmente personalizzabili a seconda delle esigenze. Possono essere allestiti con **piano** in legno multiplex di **faggio** da 30 mm o con piano in acciaio da 3 mm e sono disponibili in **3 larghezze**: 1000, 1500 o 2000 mm. I banchi Work possono presentare **gambe in acciaio fisse** e **piano inferiore** di serie, oppure **semipiano inferiore** di serie e **gambe regolabili in altezza** predisposte per l'installazione di ruote. La struttura in acciaio può ospitare armadi a porte o con cassetti, ripiani o semipiani, pannelli forati e mensole.

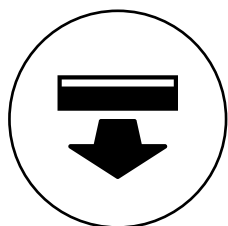

**CASSETTI AD
ESTRAZIONE
SEMPLICE**

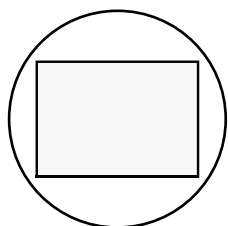

**FONDO CASSETTO
LISCIO**

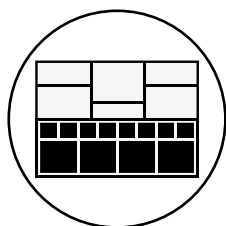

**MATERIALE DI
SEPARAZIONE**

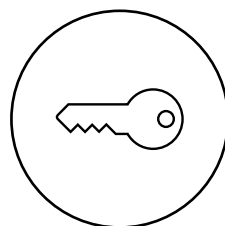

**CHIUSURA A
CHIAVE**

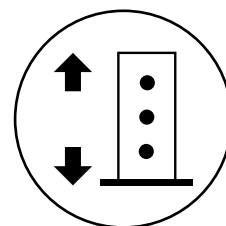

**GAMBE REGOLABILI IN
ALTEZZA**

CONFIGURAZIONI ALTERNATIVE



Utensili esclusi

[CONFIGURE](#)

[SHOP](#)

PATENTED*

ART.	L mm	P mm	H mm	KG	RAL	€
WORK2043	2307	750	1977/2352	1000	7035+7016	2013,60

Composto da:

qtà	descrizione	qtà	descrizione
1	Banco smontato regolabile con piano in multiplex 30 mm	2	Kit 3 pannelli forati/mensole con 2 bordi fermacasse
2	Armadio L=629 mm con 1 porta e 1 piano regolabile	1	Lampada doppia
1	Armadio L=500 mm con 3 cassetti H=150 mm	2	Porta bombolette inclinato a 2 posti
1	Semipiano non fessurato L=1760 mm	1	Kit porta rotolo con carta Ø=240 mm
2	Pannello forato laterale	7	Gancio Unipok per utensili - confezione 30 pezzi
1	Cestino capacità 30 L	1	Supporto multipresa a 4 scomparti
2	Porta silicone inclinato a 2 posti	1	Multipresa schuko a 4 scomparti
1	Tasca porta documenti A4	1	Cavo di collegamento wieland schuko/francese
1	Kit 3 montanti biasolati	1	Mensola grande reversibile
1	Kit 3 supporti inclinati con 2 binari		



PORTATA



RAL 7035 + RAL 7016



1000 kg

regolabili in altezza

piano in multiplex spessore 30 mm

Forniti smontati

passo fori gambe 25 mm



ART.	L mm	P mm	H mm	RAL	€
WORK1501	1500	750	732/1107	7035+7016	418,20
WORK1502	1500	750	732/1107	5012	407,40

Composto da:

qtà	descrizione
1	Banco smontato regolabile con piano in multiplex 30 mm
1	Armadio L=500 mm con 1 cassetto H=150 mm

CONFIGURE



ART.	L mm	P mm	H mm	RAL	€
WORK1503	1500	750	732/1107	7035+7016	696,90
WORK1504	1500	750	732/1107	5012	671,70

Composto da:

qtà	descrizione
1	Banco smontato regolabile con piano in multiplex 30 mm
1	Armadio L=500 mm con 4 cassetti H=105 mm
1	Semipiano non fessurato L=1260 mm

CONFIGURE



ART.	L mm	P mm	H mm	RAL	€
WORK1507	1500	750	732/1107	7035+7016	754,20
WORK1508	1500	750	732/1107	5012	729,00

Composto da:

qtà	descrizione
1	Banco smontato regolabile con piano in multiplex 30 mm
1	Armadio L=500 mm con 4 cassetti H=105 mm
1	Chiusura posteriore
1	Semipiano non fessurato L=760 mm
1	Supporto semipiano intermedio

CONFIGURE

ESEMPI DI CONFIGURAZIONE

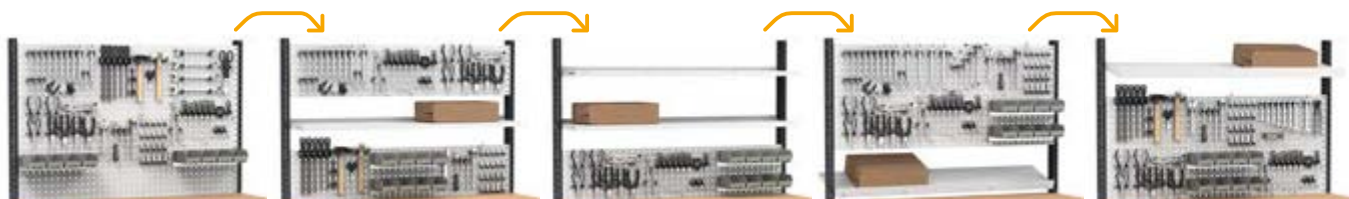

ART.	L mm	P mm	H mm	RAL	€
 WORK1528	1500	750	1675/2050	7035+7016	672,60
 WORK1534	1500	750	1675/2050	5012	661,80

Composto da:

qtà	descrizione
1	Banco smontato regolabile con piano in multiplex 30 mm
1	Armadio L=500 mm con 1 cassetto H=150 mm
1	Kit 2 montanti biasolati
1	Kit 3 pannelli forati/mensole con 2 bordi fermacasse
6	Gancio Unipok per utensili - confezione 30 pezzi
2	Barra aggancio per contenitori Picking Box mis. 1/2
2	Kit 4 contenitori Picking Box Air mis. 1

Utensili esclusi



[CONFIGURE](#) 



ART.	L mm	P mm	H mm	RAL	€
 WORK1529	1500	750	1675/2050	7035+7016	951,30
 WORK1535	1500	750	1675/2050	5012	926,10

Composto da:

qtà	descrizione
1	Banco smontato regolabile con piano in multiplex 30 mm
1	Armadio L=500 mm con 4 cassetti H=105 mm
1	Semipiano non fessurato L=1260 mm
1	Kit 2 montanti biasolati
1	Kit 3 pannelli forati/mensole con 2 bordi fermacasse
6	Gancio Unipok per utensili - confezione 30 pezzi
2	Barra aggancio per contenitori Picking Box mis. 1/2
2	Kit 4 contenitori Picking Box Air mis. 1

Utensili esclusi



[CONFIGURE](#) 



ART.	L mm	P mm	H mm	RAL	€
 WORK1530	1500	750	1675/2050	7035+7016	1008,60
 WORK1536	1500	750	1675/2050	5012	983,40

Composto da:

qtà	descrizione
1	Banco smontato regolabile con piano in multiplex 30 mm
1	Chiusura posteriore
1	Armadio L=500 mm con 4 cassetti H=105 mm
1	Semipiano non fessurato L=760 mm
1	Supporto semipiano intermedio
1	Kit 2 montanti biasolati
1	Kit 3 pannelli forati/mensole con 2 bordi fermacasse
6	Gancio Unipok per utensili - confezione 30 pezzi
2	Barra aggancio per contenitori Picking Box mis. 1/2
2	Kit 4 contenitori Picking Box Air mis. 1

Utensili esclusi



[CONFIGURE](#) 



PORTATA



RAL 7035 + RAL 7016



RAL 5012



1000 kg

regolabili in altezza

piano in multiplex spessore 30 mm

Forniti smontati

passo fori gambe 25 mm



ART.	L mm	P mm	H mm	RAL	€
WORK1505	1500	750	732/1107	7035+7016	833,70
WORK1506	1500	750	732/1107	5012	805,50

Composto da:

qtà	descrizione
1	Banco smontato regolabile con piano in multiplex 30 mm
1	Armadio L=500 mm con 4 cassetti H=105 mm
1	Armadio L=500 mm con 1 porta e 1 piano regolabile
1	Fondo di chiusura per armadio L=500 mm

CONFIGURE



ART.	L mm	P mm	H mm	RAL	€
WORK1511	1500	750	732/1107	7035+7016	728,70
WORK1512	1500	750	732/1107	5012	710,40

Composto da:

qtà	descrizione
1	Banco smontato regolabile con piano in multiplex 30 mm
2	Armadio L=629 mm con 1 cassetto H=150 mm e 1 porta
1	Semipiano non fessurato L=1260 mm

CONFIGURE



ART.	L mm	P mm	H mm	RAL	€
WORK1509	1500	750	732/1107	7035+7016	872,10
WORK1510	1500	750	732/1107	5012	843,60

Composto da:

qtà	descrizione
1	Banco smontato regolabile con piano in multiplex 30 mm
1	Armadio L=629 mm con 4 cassetti H=105 mm
1	Armadio L=629 mm con 1 porta e 1 piano regolabile
1	Semipiano non fessurato L=1260 mm

CONFIGURE

ESEMPI DI CONFIGURAZIONE

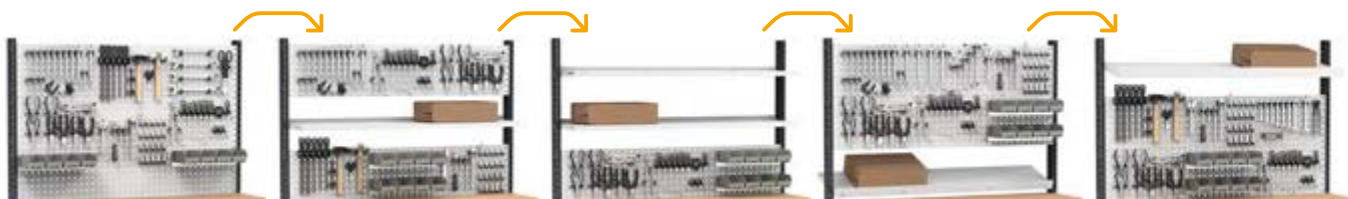

Utensili esclusi



[CONFIGURE](#)

ART.	L mm	P mm	H mm	RAL	€
WORK1531	1500	750	1675/2050	7035+7016	1088,10
WORK1537	1500	750	1675/2050	5012	1059,90

Composto da:

qtà	descrizione
1	Banco smontato regolabile con piano in multiplex 30 mm
1	Armadio L=500 mm con 1 porta e 1 piano regolabile
1	Fondo di chiusura per armadio L=500 mm
1	Armadio L=500 mm con 4 cassetti H=105 mm
1	Kit 2 montanti biasolati
1	Kit 3 pannelli forati/mensole con 2 bordi fermacasse
6	Gancio Unipok per utensili - confezione 30 pezzi
2	Barra aggancio per contenitori Picking Box mis. 1/2
2	Kit 4 contenitori Picking Box Air mis. 1



Utensili esclusi



[CONFIGURE](#)

ART.	L mm	P mm	H mm	RAL	€
WORK1532	1500	750	1675/2050	7035+7016	983,10
WORK1538	1500	750	1675/2050	5012	964,80

Composto da:

qtà	descrizione
1	Banco smontato regolabile con piano in multiplex 30 mm
2	Armadio L=629 mm con 1 cassetto H=150 mm e 1 porta
1	Semipiano non fessurato L=1260 mm
1	Kit 2 montanti biasolati
1	Kit 3 pannelli forati/mensole con 2 bordi fermacasse
6	Gancio Unipok per utensili - confezione 30 pezzi
2	Barra aggancio per contenitori Picking Box mis. 1/2
2	Kit 4 contenitori Picking Box Air mis. 1



Utensili esclusi



[CONFIGURE](#)

ART.	L mm	P mm	H mm	RAL	€
WORK1533	1500	750	1675/2050	7035+7016	1126,50
WORK1539	1500	750	1675/2050	5012	1098,00

Composto da:

qtà	descrizione
1	Banco smontato regolabile con piano in multiplex 30 mm
1	Armadio L=629 mm con 1 porta e 1 piano regolabile
1	Armadio L=629 mm con 4 cassetti H=105 mm
1	Semipiano non fessurato L=1260 mm
1	Kit 2 montanti biasolati
1	Kit 3 pannelli forati/mensole con 2 bordi fermacasse
6	Gancio Unipok per utensili - confezione 30 pezzi
2	Barra aggancio per contenitori Picking Box mis. 1/2
2	Kit 4 contenitori Picking Box Air mis. 1



PORTATA



RAL 7035 + RAL 7016



RAL 5012



1000 kg

regolabili in altezza

piano in multiplex spessore 30 mm

Forniti smontati

passo fori gambe 25 mm



ART.	L mm	P mm	H mm	RAL	€
WORK2001	2000	750	732/1107	7035+7016	460,80



WORK2002	2000	750	732/1107	5012	453,00
-----------------	------	-----	----------	------	--------

Composto da:

qtà	descrizione
1	Banco smontato regolabile con piano in multiplex 30 mm
1	Armadio L=500 mm con 1 cassetto H=150 mm

CONFIGURE



ART.	L mm	P mm	H mm	RAL	€
WORK2003	2000	750	732/1107	7035+7016	749,10



WORK2004	2000	750	732/1107	5012	726,90
-----------------	------	-----	----------	------	--------

Composto da:

qtà	descrizione
1	Banco smontato regolabile con piano in multiplex 30 mm
1	Armadio L=500 mm con 4 cassetti H=105 mm
1	Semipiano non fessurato L=1760 mm

CONFIGURE



ART.	L mm	P mm	H mm	RAL	€
WORK2005	2000	750	732/1107	7035+7016	892,50



WORK2006	2000	750	732/1107	5012	867,30
-----------------	------	-----	----------	------	--------

Composto da:

qtà	descrizione
1	Banco smontato regolabile con piano in multiplex 30 mm
1	Armadio L=500 mm con 4 cassetti H=105 mm
1	Armadio L=500 mm con 1 porta e 1 piano regolabile
1	Semipiano non fessurato L=1760 mm

CONFIGURE

ESEMPI DI CONFIGURAZIONE

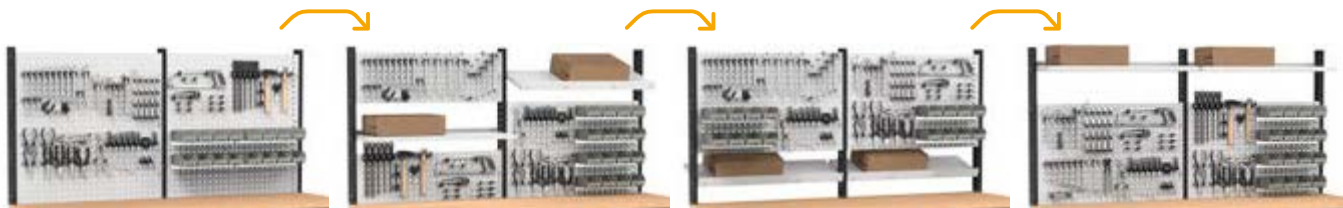

Utensili esclusi



[CONFIGURE](#)



Utensili esclusi



[CONFIGURE](#)



Utensili esclusi



[CONFIGURE](#)

ART.	L mm	P mm	H mm	RAL	€
WORK2030	2000	750	1675/2050	7035+7016	829,50
WORK2036	2000	750	1675/2050	5012	821,70

Composto da:

qtà	descrizione
1	Banco smontato regolabile con piano in multiplex 30 mm
1	Armadio L=500 mm con 1 cassetto H=150 mm
1	Kit 3 montanti biasolati
2	Kit 3 pannelli forati/mensole con 2 bordi fermacasse
6	Gancio Unipok per utensili - confezione 30 pezzi
4	Barra aggancio per contenitori Picking Box mis. 1/2
4	Kit 4 contenitori Picking Box Air mis. 1

ART.	L mm	P mm	H mm	RAL	€
WORK2031	2000	750	1675/2050	7035+7016	1117,80
WORK2037	2000	750	1675/2050	5012	1095,60

Composto da:

qtà	descrizione
1	Banco smontato regolabile con piano in multiplex 30 mm
1	Armadio L=500 mm con 4 cassetti H=105 mm
1	Semipiano non fessurato L=1760 mm
1	Kit 3 montanti biasolati
2	Kit 3 pannelli forati/mensole con 2 bordi fermacasse
6	Gancio Unipok per utensili - confezione 30 pezzi
4	Barra aggancio per contenitori Picking Box mis. 1/2
4	Kit 4 contenitori Picking Box Air mis. 1

ART.	L mm	P mm	H mm	RAL	€
WORK2032	2000	750	1675/2050	7035+7016	1261,20
WORK2038	2000	750	1675/2050	5012	1236,00

Composto da:

qtà	descrizione
1	Banco smontato regolabile con piano in multiplex 30 mm
1	Armadio L=500 mm con 1 porta e 1 piano regolabile
1	Armadio L=500 mm con 4 cassetti H=105 mm
1	Semipiano non fessurato L=1760 mm
1	Kit 3 montanti biasolati
2	Kit 3 pannelli forati/mensole con 2 bordi fermacasse
6	Gancio Unipok per utensili - confezione 30 pezzi
4	Barra aggancio per contenitori Picking Box mis. 1/2
4	Kit 4 contenitori Picking Box Air mis. 1



PORTATA



RAL 7035 + RAL 7016



RAL 5012



1000 kg



regolabili in altezza

piano in multiplex spessore 30 mm

Forniti smontati



passo fori gambe 25 mm



CONFIGURE



CONFIGURE



CONFIGURE

ART.	L mm	P mm	H mm	RAL	€
WORK2007	2000	750	732/1107	7035+7016	981,60
WORK2008	2000	750	732/1107	5012	956,40

Composto da:

qtà	descrizione
1	Banco smontato regolabile con piano in multiplex 30 mm
1	Armadio L=500 mm con 4 cassetti H=105 mm
1	Armadio L=500 mm con 1 porta e 1 piano regolabile
1	Chiusura posteriore
1	Semipiano non fessurato L=760 mm
1	Fondo di chiusura per armadio L=500 mm

ART.	L mm	P mm	H mm	RAL	€
WORK2011	2000	750	732/1107	7035+7016	953,10
WORK2012	2000	750	732/1107	5012	928,20

Composto da:

qtà	descrizione
1	Banco smontato regolabile con piano in multiplex 30 mm
1	Armadio L=500 mm con 1 cassetto H=150 mm e 1 porta
2	Armadio L=629 mm con 1 cassetto H=150 mm e 1 porta
1	Semipiano non fessurato L=1760 mm

ART.	L mm	P mm	H mm	RAL	€
WORK2009	2000	750	732/1107	7035+7016	1061,10
WORK2010	2000	750	732/1107	5012	1032,90

Composto da:

qtà	descrizione
1	Banco smontato regolabile con piano in multiplex 30 mm
1	Armadio L=500 mm con 4 cassetti H=105 mm
2	Armadio L=629 mm con 1 porta e 1 piano regolabile
1	Semipiano non fessurato L=1760 mm

ESEMPI DI CONFIGURAZIONE

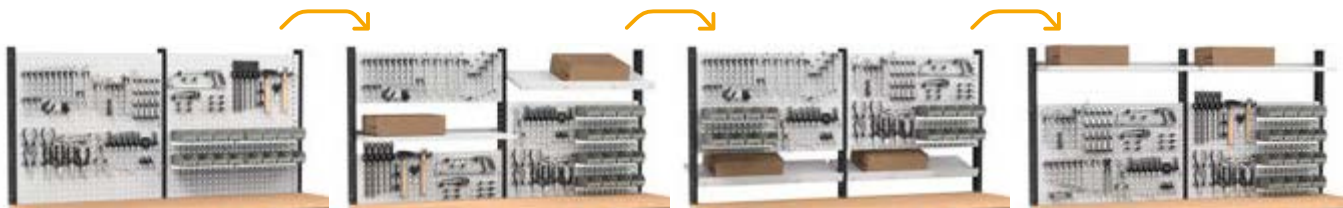

Utensili esclusi



[CONFIGURE](#)



Utensili esclusi



[CONFIGURE](#)



Utensili esclusi





[CONFIGURE](#)

ART.	L mm	P mm	H mm	RAL	€
 WORK2033	2000	750	1675/2050	7035+7016	1350,30
 WORK2039	2000	750	1675/2050	5012	1325,10



Composto da:

qtà	descrizione
1	Banco smontato regolabile con piano in multiplex 30 mm
1	Chiusura posteriore
1	Armadio L=500 mm con 1 porta e 1 piano regolabile
1	Fondo di chiusura per armadio L=500 mm
1	Armadio L=500 mm con 4 cassetti H=105 mm
1	Semipiano non fessurato L=760 mm
1	Kit 3 montanti biasolati
2	Kit 3 pannelli forati/mensole con 2 bordi fermacasse
6	Gancio Unipok per utensili - confezione 30 pezzi
4	Barra aggancio per contenitori Picking Box mis. 1/2
4	Kit 4 contenitori Picking Box Air mis. 1

ART.	L mm	P mm	H mm	RAL	€
 WORK2034	2000	750	1675/2050	7035+7016	1321,80
 WORK2040	2000	750	1675/2050	5012	1296,90

Composto da:

qtà	descrizione
1	Banco smontato regolabile con piano in multiplex 30 mm
2	Armadio L=629 mm con 1 cassetto H=150 mm e 1 porta
1	Armadio L=500 mm con 1 cassetto H=150 mm e 1 porta
1	Semipiano non fessurato L=1760 mm
1	Kit 3 montanti biasolati
2	Kit 3 pannelli forati/mensole con 2 bordi fermacasse
6	Gancio Unipok per utensili - confezione 30 pezzi
4	Barra aggancio per contenitori Picking Box mis. 1/2
4	Kit 4 contenitori Picking Box Air mis. 1

ART.	L mm	P mm	H mm	RAL	€
 WORK2035	2000	750	1675/2050	7035+7016	1429,80
 WORK2041	2000	750	1675/2050	5012	1401,60

Composto da:

qtà	descrizione
1	Banco smontato regolabile con piano in multiplex 30 mm
2	Armadio L=629 mm con 1 porta e 1 piano regolabile
1	Armadio L=500 mm con 4 cassetti H=105 mm
1	Semipiano non fessurato L=1760 mm
1	Kit 3 montanti biasolati
2	Kit 3 pannelli forati/mensole con 2 bordi fermacasse
6	Gancio Unipok per utensili - confezione 30 pezzi
4	Barra aggancio per contenitori Picking Box mis. 1/2
4	Kit 4 contenitori Picking Box Air mis. 1



PORTATA



RAL 7035 + RAL 7016



RAL 5012

COMPONENTI

L ➔ 1000 - 1500 - 2000 mm

 1000 kg

 regolabili in altezza

 piano in multiplex spessore 30 mm

 Forniti smontati

 passo fori gambe 25 mm

 piano in acciaio spessore 3 mm

BANCO WORK CON PIANO IN ACCIAIO



3D



3D



3D



ART.	L mm	P mm	H mm	piano		RAL	€
				materiale	mm		
FBG01S1000R00PD	1031	704	737/1112	Acciaio	2,5	7035+7016	271,80
FBG01S1000R0004	1031	704	737/1112	Acciaio	2,5	5012	258,90
FBG01S1500R00PD	1507	704	737/1112	Acciaio	2,5	7035+7016	327,60
FBG01S1500R0004	1507	704	737/1112	Acciaio	2,5	5012	308,40
FBG01S2000R00PD	2007	704	737/1112	Acciaio	2,5	7035+7016	370,20
FBG01S2000R0004	2007	704	737/1112	Acciaio	2,5	5012	354,00

BANCO WORK CON PIANO IN LEGNO



3D



3D



3D



ART.	L mm	P mm	H mm	piano		RAL	€
				materiale	mm		
FBG02S1000R00PD	1024	750	732/1107	Multiplex	30	7035+7016	271,80
FBG02S1000R0004	1024	750	732/1107	Multiplex	30	5012	258,90
FBG02S1500R00PD	1500	750	732/1107	Multiplex	30	7035+7016	314,70
FBG02S1500R0004	1500	750	732/1107	Multiplex	30	5012	308,40
FBG02S2000R00PD	2000	750	732/1107	Multiplex	30	7035+7016	357,30
FBG02S2000R0004	2000	750	732/1107	Multiplex	30	5012	354,00



IMBALLO BANCO SMONTATO

KIT RUOTE

Adatte solo per i banchi Work



3D

3D

ART.	Ø mm	 KG	H mm	materiale			€
FKRU1252101	125	300	155	Gomma antitraccia sintetica	2	2	53,40
FKRS1252101	125	750	155	Gomma elastica	2	2	85,20



RUOTA GIREVOLE CON FRENO



RUOTA FISSA

COPPIA SQUADRE DI RINFORZO



ART.	L mm	P mm	H mm	RAL	€
FBGKITS0008	145	39	145	7035	17,10
FBGKITS0004	145	39	145	5012	17,10



Utilizzare una coppia squadre per gamba se non è presente la cassettera

WORK

COMPONENTI

L ➤ 1000 - 1500 - 2000 mm

 1000 kg

 piano in multiplex spessore 30 mm

 Forniti smontati

 piano in acciaio spessore 3 mm

BANCO WORK CON PIANO IN ACCIAIO



3D



3D



3D



ART.	L mm	P mm	H mm	piano		RAL	€
				materiale	mm		
FBG01S1000F00PD	1031	704	887	Acciaio	2,5	7035+7016	229,20
FBG01S1000F0004	1031	704	887	Acciaio	2,5	5012	222,90
FBG01S1500F00PD	1507	704	887	Acciaio	2,5	7035+7016	291,60
FBG01S1500F0004	1507	704	887	Acciaio	2,5	5012	278,70
FBG01S2000F00PD	2007	704	887	Acciaio	2,5	7035+7016	341,10
FBG01S2000F0004	2007	704	887	Acciaio	2,5	5012	324,60

BANCO WORK CON PIANO IN LEGNO



3D



3D



3D



ART.	L mm	P mm	H mm	piano		RAL	€
				materiale	mm		
FBG02S1000F0008	1024	750	882	Multiplex	30	7035	222,90
FBG02S1000F0004	1024	750	882	Multiplex	30	5012	222,90
FBG02S1500F0008	1500	750	882	Multiplex	30	7035	278,70
FBG02S1500F0004	1500	750	882	Multiplex	30	5012	278,70
FBG02S2000F0008	2000	750	882	Multiplex	30	7035	324,60
FBG02S2000F0004	2000	750	882	Multiplex	30	5012	324,60



IMBALLO BANCO SMONTATO

COPERTURA PER PIANO IN ACCIAIO



3D

3D

3D

ART.	L mm	P mm	H mm	€
FBG32100007	1024	702	27	82,80
FBG32150007	1500	702	27	114,60
FBG32200007	2000	702	27	146,40

COPERTURA PER PIANO IN MULTIPLEX



3D

3D

3D

3D

ART.	L mm	P mm	H mm	€
FBL22300007	1028	754	22	82,80
FBL22600007	1504	754	22	114,60
FBL22900007	2004	754	22	146,40
FBL23200007	3004	754	22	274,20



PORTATA



SPESORE



RAL 7035 + RAL 7016



RAL 5012



RAL 7035

1000



1500

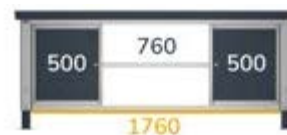

ARMADI CON CASSETTI

L → 500 mm

ARMADIO CON 1 CASSETTO



ART.	L mm	P mm	H mm	cassetti			porta		RAL	€	
				n.	KG	h mm	n.	h ingresso mm			
FBG03S50C0001PD	500	630	210	1	80	86%	150	-	-	7035+7016	103,50
FBG03S50C000104	500	630	210	1	80	86%	150	-	-	5012	99,00

ARMADIO CON 3 CASSETTI



ART.	L mm	P mm	H mm	cassetti			porta		RAL	€	
				n.	KG	h mm	n.	h ingresso mm			
FBG03S50C0002PD	500	630	570	3	80	86%	150	-	-	7035+7016	251,40
FBG03S50C000204	500	630	570	3	80	86%	150	-	-	5012	237,30

ARMADIO CON 4 CASSETTI



ART.	L mm	P mm	H mm	cassetti			porta		RAL	€	
				n.	KG	h mm	n.	h ingresso mm			
FBG03S50C0003PD	500	630	570	4	80	86%	105	-	-	7035+7016	343,80
FBG03S50C000304	500	630	570	4	80	86%	105	-	-	5012	324,90

ARMADIO CON 1 CASSETTO E 1 PORTA



ART.	L mm	P mm	H mm	cassetti			porta		RAL	€	
				n.	KG	h mm	n.	h ingresso mm			
FBG03S50C0004PD	500	630	570	1	80	86%	150	1	310	7035+7016	172,20
FBG03S50C000404	500	630	570	1	80	86%	150	1	310	5012	162,60

Senza fondo di chiusura

ARMADIO CON 1 PORTA E 1 PIANO





ART.	L mm	P mm	H mm	cassetti			porta		RAL	€	
				n.	KG	h mm	n.	h ingresso mm			
FBG03S50C0005PD	500	612	570	-	-	-%	-	1	491	7035+7016	143,40
FBG03S50C000504	500	612	570	-	-	-%	-	1	491	5012	140,40

Senza fondo di chiusura



FONDO DI CHIUSURA

FONDO DI CHIUSURA PER ARMADI L= 500 mm

ART.	L mm	P mm	H mm	RAL	€
 FBG16S50V0V0008	494	572	4	7035	31,80
 FBG16S50V0V0004	494	572	4	5012	31,80

 Da utilizzare sull'armadio con porta quando è presente il semipiano

FONDO DI CHIUSURA PER ARMADI L= 629 mm

ART.	L mm	P mm	H mm	RAL	€
 FBG16S63V0V0008	623	572	4	7035	31,80
 FBG16S63V0V0004	623	572	4	5012	31,80



 Da utilizzare sull'armadio con porta quando è presente il semipiano





ARMADI CON CASSETTI

L → 629 mm



ARMADIO CON 3 CASSETTI

ART.	L mm	P mm	H mm	cassetti				porta		RAL	€
				n.	KG		h mm	n.	h ingresso mm		
 FBG03S63C0002PD	629	630	570	3	80	86%	150	-	-	7035+7016	280,20
 FBG03S63C000204	629	630	570	3	80	86%	150	-	-	5012	264,30

ARMADIO CON 4 CASSETTI



ART.	L mm	P mm	H mm	cassetti				porta		RAL	€
				n.	KG		h mm	n.	h ingresso mm		
 FBG03S63C0003PD	629	630	570	4	80	86%	105	-	-	7035+7016	363,00
 FBG03S63C000304	629	630	570	4	80	86%	105	-	-	5012	343,80

ARMADIO CON 1 CASSETTO E 1 PORTA

ART.	L mm	P mm	H mm	cassetti				porta		RAL	€
				n.	KG		h mm	n.	h ingresso mm		
 FBG03S63C0004PD	629	630	570	1	80	86%	150	1	310	7035+7016	187,80
 FBG03S63C000404	629	630	570	1	80	86%	150	1	310	5012	181,80

 Senza fondo di chiusura

ARMADIO CON 1 PORTA E 1 PIANO

ART.	L mm	P mm	H mm	cassetti				porta		RAL	€
				n.	KG		h mm	n.	h ingresso mm		
 FBG03S63C0005PD	629	612	570	-	-	-%	-	1	491	7035+7016	156,00
 FBG03S63C000504	629	612	570	-	-	-%	-	1	491	5012	153,00

 Senza fondo di chiusura

 PORTATA
  ESTRAZIONE
  RAL 7035 + RAL 7016
  RAL 5012
  RAL 7035



CHIUSURA POSTERIORE

ART.	L mm	H mm	adatto per banco L mm	RAL	€
FBG12S080000008	825	665	1024-1031	7035	46,50
FBG12S080000004	825	665	1024-1031	5012	46,50
FBG12S130000008	1325	665	1500-1507	7035	55,80
FBG12S130000004	1325	665	1500-1507	5012	55,80
FBG12S180000008	1825	665	2000-2007	7035	75,00
FBG12S180000004	1825	665	2000-2007	5012	75,00



COPIA TAMPONI LATERALI

Per banco L=1024-1031 mm con armadio L=629 mm

ART.	L mm	P mm	H mm	RAL	€
FBG14S130V00008	65	35	568	7035	17,70
FBG14S130V00004	65	35	568	5012	17,70



PANNELLO FORATO LATERALE

ART.	L mm	P mm	H mm	Dim. foro mm	RAL	€
FBG15S00V0V0008	610	75	669	10x10	7035	44,70
FBG15S00V0V0004	610	75	669	10x10	5012	44,70



PIANO NON FESSURATO AGGIUNTIVO

ART.	L mm	P mm	H mm	KG	RAL	€
FBG08S070600108	760	600	35	250	7035	44,70
FBG08S070600104	760	600	35	250	5012	44,70
FBG08S120600108	1260	600	35	250	7035	59,10
FBG08S120600104	1260	600	35	250	5012	59,10
FBG08S170600108	1760	600	35	200	7035	75,00
FBG08S170600104	1760	600	35	200	5012	75,00



SEMIPIANO NON FESSURATO AGGIUNTIVO

ART.	L mm	P mm	H mm	KG	RAL	€
FBG09S070300108	760	300	35	100	7035	30,30
FBG09S070300104	760	300	35	100	5012	30,30
FBG09S120300108	1260	300	35	100	7035	38,40
FBG09S120300104	1260	300	35	100	5012	38,40
FBG09S170300108	1760	300	35	100	7035	48,00
FBG09S170300104	1760	300	35	100	5012	48,00



SUPPORTO SOLO PER SEMIPIANO AGGIUNTIVO

ART.	L mm	P mm	H mm	RAL	€
FBG13S605V00008	605	77	35	7035	9,60
FBG13S605V00004	605	77	35	5012	9,60

ART.	L mm	P mm	H mm	KG	RAL	€
WORK2014	2007	704	737/1112	1000	7035+7016	1083,90



Composto da:

qtà	descrizione
1	Banco smontato regolabile con piano in acciaio 2,5 mm
1	Armadio L=500 mm con 4 cassetti H=105 mm
1	Armadio L=500 mm con 1 porta e 1 piano regolabile
1	Chiusura posteriore
1	Semipiano non fessurato L=760 mm
1	Fondo di chiusura per armadio L=500 mm
2	Pannello forato laterale

[CONFIGURE](#)



PORTATA



RAL 7035 + RAL 7016



RAL 5012



RAL 7035



MATERIALE DI SEPARAZIONE

L → 500 mm



ART.	adatto per cassetto H mm	n. divisori trasversali	€
FBG18S50DV00199	105/150	3	12,60



ART.	adatto per cassetto H mm	n. divisori trasversali	n. divisori longitudinali	€
FBG18S50DV00299	105/150	1	1	9,00



ART.	adatto per cassetto H mm	componenti	€
FBG18S50CD00103	105/150	4 x Cassetta divisorio 100x50 mm	7,50



ART.	adatto per cassetto H mm	componenti	€
FBG18S50CD00203	105/150	3 x Cassetta divisorio 100x50 mm 2 x Cassetta divisorio 150x75 mm 1 x Cassetta divisorio 150x150 mm	11,40



ART.	adatto per cassetto H mm	componenti	€
MATSEP001	105/150	1 x FBG18S50CD00103 1 x FBG18S50CD00203 1 x FBG18S50DV00299	27,90



ART.	adatto per cassetto H mm	componenti	€
MATSEP002	105/150	1 x FBG18S50CD00103 2 x FBG18S50CD00203 1 x FBG18S50DV00299	39,30



TAPPETO PER CASSETTIERA L=500 MM

ART.	materiale	€
FBG18S50TP00107	Poliestere	4,50



MATERIALE DI SEPARAZIONE

L → 629 mm



ART.	adatto per cassetto H mm	n. divisori trasversali	€
FBG18S63DV00199	105/150	3	13,50



ART.	adatto per cassetto H mm	n. divisori trasversali	n. divisori longitudinali	€
FBG18S63DV00299	105/150	1	1	9,60



ART.	adatto per cassetto H mm	componenti	€
FBG18S63CD00103	105/150	5 x Cassetta divisorio 100x50 mm	9,30



ART.	adatto per cassetto H mm	componenti	€
FBG18S63CD00203	105/150	2 x Cassetta divisorio 75x75 mm 2 x Cassetta divisorio 150x75 mm 2 x Cassetta divisorio 150x150 mm	11,40



ART.	adatto per cassetto H mm	componenti	€
MATSEP003	105/150	1 x FBG18S63CD00103 1 x FBG18S63CD00203 1 x FBG18S63DV00299	30,30



ART.	adatto per cassetto H mm	componenti	€
MATSEP004	105/150	1 x FBG18S63CD00103 2 x FBG18S63CD00203 1 x FBG18S63DV00299	41,70



TAPPETO PER CASSETTIERA L=629 MM

ART.	materiale	€
FBG18S63TP00107	Poliestere	5,70



CONFIGURAZIONI ALTERNATIVE



Utensili esclusi



ART.	L mm	P mm	H mm	KG	RAL	€
WORK2042	2260	704	2098	1000	7035+7016	1906,80

Composto da:

qtà	descrizione	qtà	descrizione
1	Banco smontato con piano in acciaio 2,5 mm	7	Gancio Unipok per utensili - confezione 30 pezzi
2	Armadio L=629 mm con 1 cassetto H=150 mm e 1 porta	1	Kit porta rotolo con carta Ø=240 mm
1	Armadio L=500 mm con 1 cassetto H=150 mm e 1 porta	2	Porta bombolette inclinato a 2 posti
2	Pannello forato laterale	1	Mensola grande reversibile
1	Cestino capacità 30 L	1	Supporto multipresa a 4 scomparti
1	Kit 3 montanti biasolati	1	Multipresa schuko a 4 scomparti
1	Kit 3 supporti inclinati con 2 binari	1	Cavo di collegamento wieland schuko/francese
2	Kit 3 pannelli forati/mensole con 2 bordi fermacasse	2	Barra aggancio per contenitori Picking Box mis. 1/2
1	Lampada doppia	2	Kit 4 contenitori Picking Box Air mis. 1

CONFIGURAZIONI ALTERNATIVE

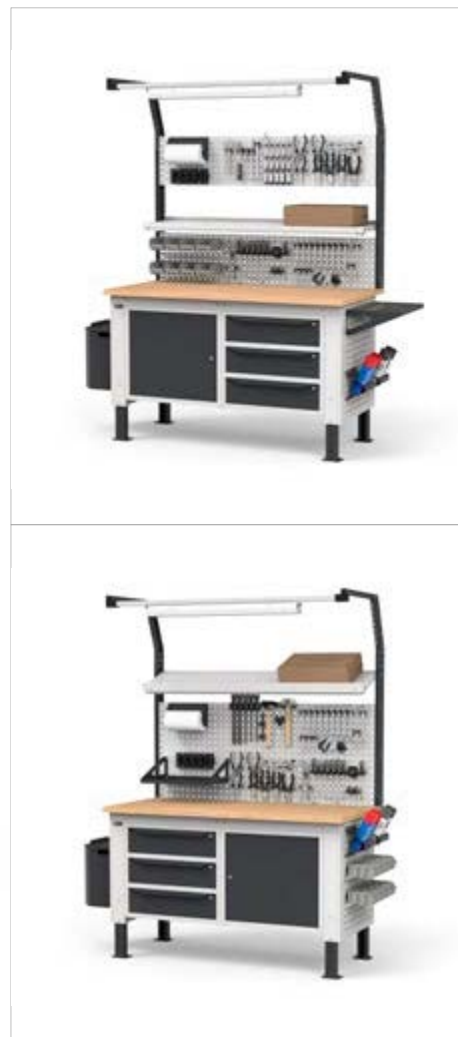

Utensili esclusi



ART.	L mm	P mm	H mm	KG	RAL	€
WORK1540	2052	750	1977/2352	1000	7035+7016	1717,20

Composto da:

qtà	descrizione	qtà	descrizione
1	Banco smontato regolabile con piano in multiplex 30 mm	1	Kit 3 pannelli forati/mensole con 2 bordi fermacasse
1	Armadio L=629 mm con 1 porta e 1 piano regolabile	1	Lampada doppia
1	Fondo di chiusura per armadio L=629 mm	1	Lampada singola
1	Armadio L=629 mm con 3 cassetti H=150 mm	1	Kit porta rotolo con carta Ø=130 mm
2	Pannello forato laterale	1	Supporto multipresa a 4 scomparti
1	Cestino capacità 30 L	1	Multipresa schuko a 4 scomparti
1	Mensola grande reversibile	1	Cavo di collegamento wieland schuko/francese
2	Porta bombolette inclinato a 2 posti	4	Gancio Unipok per utensili - confezione 30 pezzi
1	Kit 2 montanti biasolati	2	Barra aggancio per contenitori Picking Box mis. 1/2
1	Kit 2 supporti inclinati con binario	2	Kit 4 contenitori Picking Box Air mis. 1



PORTATA



RAL 7035 + RAL 7016

WORK MASTER BR

BANCHI DA LAVORO SERIE PRO

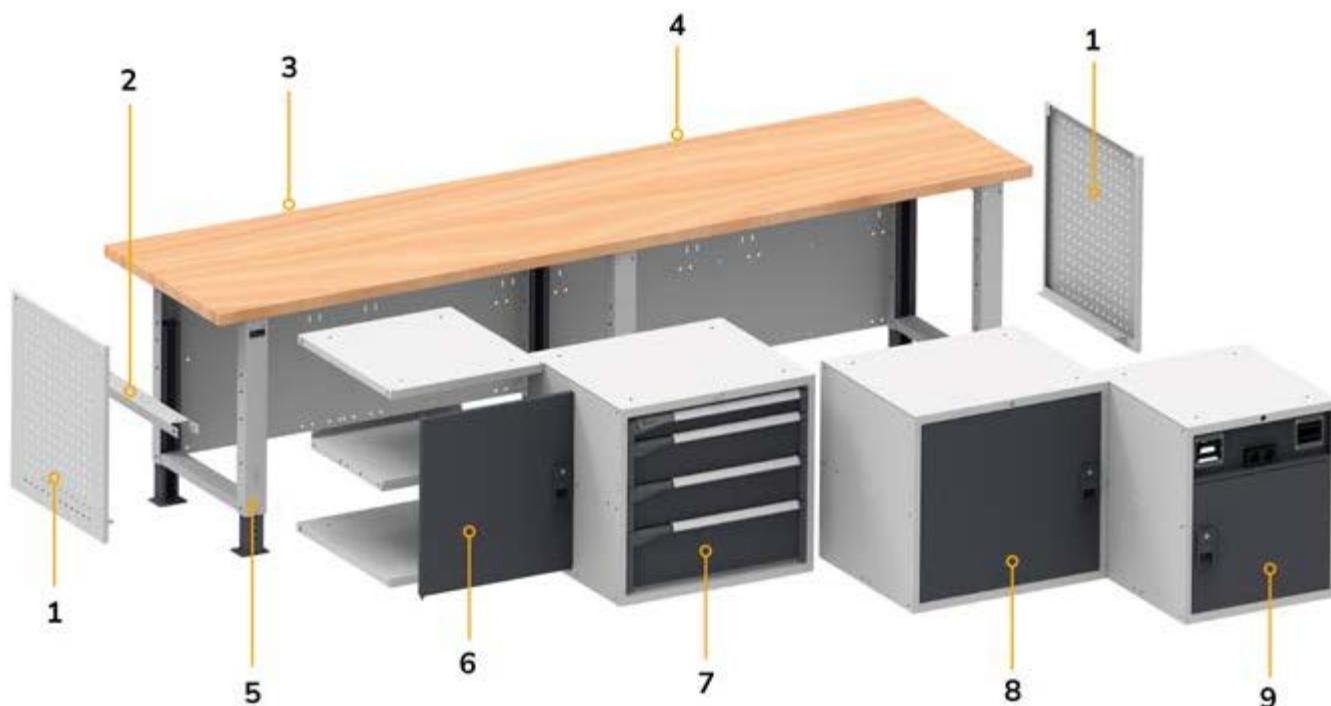

1. Pannello forato laterale
2. Supporto semipiano intermedio
3. Chiusura posteriore
4. Piano in Multiplex
5. Gambe regolabili
6. Modulo componibile
7. Armadio a cassetti
8. Armadio con porta
9. Armadio tecnico con porta

Il banco Work Master BR presenta una **struttura modulare** che permette di ampliarlo e arricchirlo in qualsiasi momento, adattandosi costantemente ai bisogni dell'utilizzatore. Disponibile in **4 larghezze**, da 1000 a 3000 mm, è dotato di un robusto **piano** di lavoro in legno multiplex di **faggio** con spessore 40 mm e da **gambe regolabili in altezza** per una posizione ergonomica nel lavoro. Può essere allestito con soluzioni ad alta capacità come pareti porta attrezzi, armadi a ripiani, con porte e cassettiere. Quest'ultime sono personalizzabili sia in termini di estrazione, da 92 a 100%, che di portata, da 50 a 100 kg.

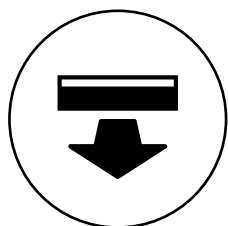

CASSETTI AD
ESTRAZIONE
TOTALE

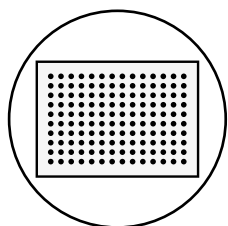

FONDO CASSETTO
FORATO

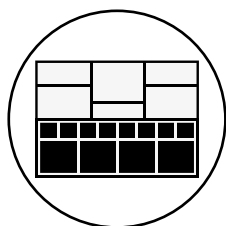

MATERIALE DI
SEPARAZIONE

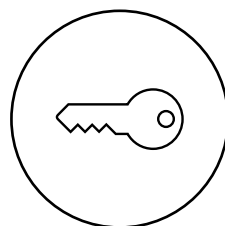

CHIUSURA A
CHIAVE

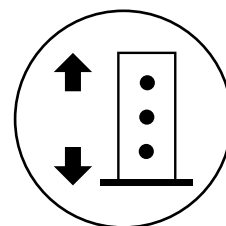

GAMBE REGOLABILI IN
ALTEZZA

WORK MASTER BR



CONFIGURE

SHOP

PATENTED

ART.	L mm	P mm	H mm	KG	RAL	€
MASTERBR2007	2206	750	1805/2180	1000	7035+7016	2784,00

Composto da:

qtà	descrizione	qtà	descrizione
1	Banco smontato con piano in multiplex 40 mm	2	Pensile vasistas senza serratura
1	Armadio L=560 mm con 4 cassetti 1x75 2x150 1x200	2	Coppia staffe di fissaggio pensile su montanti
4	Piano superiore/inferiore L=560 mm	2	Barra led
1	Porta totale destra H=600 mm con maniglia Dark Grey	2	Multipresa schuko a 2 scomparti
1	Porta totale sinistra H=600 mm con maniglia Dark Grey	1	Multipresa schuko a 4 scomparti
2	Supporto semipiano intermedio	1	Magnetotermico differenziale
2	Piano interno L=558 mm	1	Cavo di collegamento wieland schuko/francese
2	Pannello forato laterale	1	Tasca porta documenti A4
1	Pannello forato/mensola con 1 bordo fermacasse	1	Kit porta rotolo con carta Ø=240 mm
1	Kit 3 montanti biasolati	2	Porta bombole inclinato a 2 posti
1	Kit 2 pannelli forati/mensole con 1 bordo fermacasse	5	Gancio Unipok per utensili - confezione 30 pezzi
1	Pannello forato Electric	1	Cestino capacità 30 L

KG

PORTATA

■ ■

RAL 7035 + RAL 7016



1000 kg

regolabili in altezza

piano in multiplex spessore 40 mm

Forniti smontati

passo fori gambe 25 mm



ART.	L mm	P mm	H mm	RAL	€
MASTERBR1505	1500	750	740/1115	7035+7016	796,20

Composto da:

qtà	descrizione
1	Banco smontato con piano in multiplex 40 mm
1	Armadio L=560 mm con 3 cassetti 1x75 2x100
1	Coppia squadre di rinforzo



[CONFIGURE](#)



ART.	L mm	P mm	H mm	RAL	€
MASTERBR1506	1500	750	740/1115	7035+7016	873,60

Composto da:

qtà	descrizione
1	Banco smontato con piano in multiplex 40 mm
1	Armadio L=560 mm con 4 cassetti 1x75 2x150 1x200
1	Coppia squadre di rinforzo



[CONFIGURE](#)



ART.	L mm	P mm	H mm	RAL	€
MASTERBR1501	1500	750	740/1115	7035+7016	1014,30

Composto da:

qtà	descrizione
1	Banco smontato con piano in multiplex 40 mm
1	Armadio L=560 mm con 4 cassetti 1x75 2x150 1x200
2	Semipiano aggiuntivo L=560 mm
1	Supporto semipiano intermedio
2	Pannello forato laterale



[CONFIGURE](#)

ESEMPI DI CONFIGURAZIONE



Utensili esclusi



[CONFIGURE](#)



ART.	L mm	P mm	H mm	RAL	€
MASTERBR1514	1500	750	1683/2058	7035+7016	1050,60

Composto da:

qtà	descrizione
1	Banco smontato con piano in multiplex 40 mm
1	Armadio L=560 mm con 3 cassetti 1x75 2x100
1	Coppia squadre di rinforzo
1	Kit 2 montanti biasolati
1	Kit 3 pannelli forati/mensole con 2 bordi fermacasse
6	Gancio Unipok per utensili - confezione 30 pezzi
2	Barra aggancio per contenitori Picking Box mis. 1/2
2	Kit 4 contenitori Picking Box Air mis. 1



Utensili esclusi



[CONFIGURE](#)



ART.	L mm	P mm	H mm	RAL	€
MASTERBR1515	1500	750	1683/2058	7035+7016	1128,00

Composto da:

qtà	descrizione
1	Banco smontato con piano in multiplex 40 mm
1	Armadio L=560 mm con 4 cassetti 1x75 2x150 1x200
1	Coppia squadre di rinforzo
1	Kit 2 montanti biasolati
1	Kit 3 pannelli forati/mensole con 2 bordi fermacasse
6	Gancio Unipok per utensili - confezione 30 pezzi
2	Barra aggancio per contenitori Picking Box mis. 1/2
2	Kit 4 contenitori Picking Box Air mis. 1



Utensili esclusi



[CONFIGURE](#)



ART.	L mm	P mm	H mm	RAL	€
MASTERBR1510	1500	750	1683/2058	7035+7016	1268,70

Composto da:

qtà	descrizione
1	Banco smontato con piano in multiplex 40 mm
2	Pannello forato laterale
1	Armadio L=560 mm con 4 cassetti 1x75 2x150 1x200
2	Semipiano aggiuntivo L=560 mm
1	Supporto semipiano intermedio
1	Kit 2 montanti biasolati
1	Kit 3 pannelli forati/mensole con 2 bordi fermacasse
6	Gancio Unipok per utensili - confezione 30 pezzi
2	Barra aggancio per contenitori Picking Box mis. 1/2
2	Kit 4 contenitori Picking Box Air mis. 1



PORTATA

RAL 7035 + RAL 7016



1000 kg



regolabili in altezza

piano in multiplex spessore 40 mm

Forniti smontati



passo fori gambe 25 mm



ART.	L mm	P mm	H mm	RAL	€
MASTERBR1502	1500	750	740/1115	7035+7016	1103,40

Composto da:

qtà	descrizione
1	Banco smontato con piano in multiplex 40 mm
1	Armadio L=560 mm con 4 cassetti 1x75 2x150 1x200
2	Piano superiore/inferiore L=560 mm
1	Porta totale sinistra H=600 mm con maniglia Dark Grey
1	Supporto semipiano intermedio
1	Piano interno L=558 mm
2	Pannello forato laterale



CONFIGURE



ART.	L mm	P mm	H mm	RAL	€
MASTERBR1503	1500	750	740/1115	7035+7016	1480,50

Composto da:

qtà	descrizione
1	Banco smontato con piano in multiplex 40 mm
1	Armadio L=560 mm con 4 cassetti 1x75 2x150 1x200
1	Armadio L=560 mm con 5 cassetti 1x75 3x100 1x200



CONFIGURE



ART.	L mm	P mm	H mm	RAL	€
MASTERBR1504	1500	750	740/1115	7035+7016	1025,10

Composto da:

qtà	descrizione
1	Banco smontato con piano in multiplex 40 mm
2	Armadio L=560 mm predisposto per porta con 1 cassetto H=150 mm
1	Porta parziale sinistra H=435 mm con maniglia Dark Grey
1	Porta parziale destra H=435 mm con maniglia Dark Grey



CONFIGURE

ESEMPI DI CONFIGURAZIONE



Utensili esclusi



CONFIGURE



Utensili esclusi



CONFIGURE



Utensili esclusi



CONFIGURE



ART.	L mm	P mm	H mm	RAL	€
MASTERBR1511	1500	750	1683/2058	7035+7016	1357,80

Composto da:

qtà	descrizione
1	Banco smontato con piano in multiplex 40 mm
2	Pannello forato laterale
1	Armadio L=560 mm con 4 cassetti 1x75 2x150 1x200
2	Piano superiore/inferiore L=560 mm
1	Porta totale sinistra H=600 mm con maniglia Dark Grey
1	Piano interno L=558 mm
1	Supporto semipiano intermedio
1	Kit 2 montanti biasolati
1	Kit 3 pannelli forati/mensole con 2 bordi fermacasse
6	Gancio Unipok per utensili - confezione 30 pezzi
2	Barra aggancio per contenitori Picking Box mis. 1/2
2	Kit 4 contenitori Picking Box Air mis. 1



ART.	L mm	P mm	H mm	RAL	€
MASTERBR1512	1500	750	1683/2058	7035+7016	1734,90

Composto da:

qtà	descrizione
1	Banco smontato con piano in multiplex 40 mm
1	Armadio L=560 mm con 4 cassetti 1x75 2x150 1x200
1	Armadio L=560 mm con 5 cassetti 1x75 3x100 1x200
1	Kit 2 montanti biasolati
1	Kit 3 pannelli forati/mensole con 2 bordi fermacasse
6	Gancio Unipok per utensili - confezione 30 pezzi
2	Barra aggancio per contenitori Picking Box mis. 1/2
2	Kit 4 contenitori Picking Box Air mis. 1



ART.	L mm	P mm	H mm	RAL	€
MASTERBR1513	1500	750	1683/2058	7035+7016	1279,50

Composto da:

qtà	descrizione
1	Banco smontato con piano in multiplex 40 mm
2	Armadio L=560 mm predisposto per porta con 1 cassetto H=150 mm
1	Porta parziale sinistra H=435 mm con maniglia Dark Grey
1	Porta parziale destra H=435 mm con maniglia Dark Grey
1	Kit 2 montanti biasolati
1	Kit 3 pannelli forati/mensole con 2 bordi fermacasse
6	Gancio Unipok per utensili - confezione 30 pezzi
2	Barra aggancio per contenitori Picking Box mis. 1/2
2	Kit 4 contenitori Picking Box Air mis. 1



PORTATA



RAL 7035 + RAL 7016



1000 kg

regolabili in altezza

piano in multiplex spessore 40 mm

Forniti smontati

passo fori gambe 25 mm



ART.	L mm	P mm	H mm	RAL	€
MASTERBR2005	2000	750	740/1115	7035+7016	850,80

Composto da:

qtà	descrizione
1	Banco smontato con piano in multiplex 40 mm
1	Armadio L=560 mm con 3 cassetti 1x75 2x100
1	Coppia squadre di rinforzo



[CONFIGURE](#)



ART.	L mm	P mm	H mm	RAL	€
MASTERBR2006	2000	750	740/1115	7035+7016	928,20

Composto da:

qtà	descrizione
1	Banco smontato con piano in multiplex 40 mm
1	Armadio L=560 mm con 4 cassetti 1x75 2x150 1x200
1	Coppia squadre di rinforzo



[CONFIGURE](#)



ART.	L mm	P mm	H mm	RAL	€
MASTERBR2001	2000	750	740/1115	7035+7016	1236,00

Composto da:

qtà	descrizione
1	Banco smontato con piano in multiplex 40 mm
1	Armadio L=560 mm con 4 cassetti 1x75 2x150 1x200
1	Armadio L=560 mm predisposto per porta con 1 piano regolabile
1	Porta totale sinistra H=600 mm con maniglia Dark Grey
2	Semipiano aggiuntivo L=560 mm



[CONFIGURE](#)

ESEMPI DI CONFIGURAZIONE

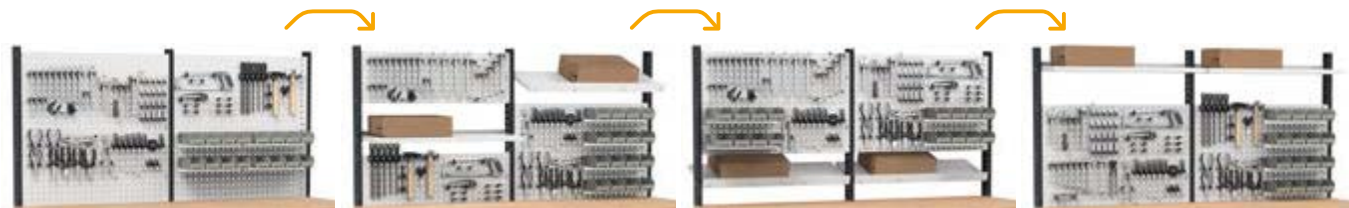

Utensili esclusi



[CONFIGURE](#)



Utensili esclusi



[CONFIGURE](#)



Utensili esclusi



[CONFIGURE](#)



ART.	L mm	P mm	H mm	RAL	€
MASTERBR2013	2000	750	1683/2058	7035+7016	1219,50

Composto da:

qtà	descrizione
1	Banco smontato con piano in multiplex 40 mm
1	Armadio L=560 mm con 3 cassetti 1x75 2x100
1	Coppia squadre di rinforzo
1	Kit 3 montanti biasolati
2	Kit 3 pannelli forati/mensole con 2 bordi fermacasse
6	Gancio Unipok per utensili - confezione 30 pezzi
4	Barra aggancio per contenitori Picking Box mis. 1/2
4	Kit 4 contenitori Picking Box Air mis. 1



ART.	L mm	P mm	H mm	RAL	€
MASTERBR2014	2000	750	1683/2058	7035+7016	1296,90

Composto da:

qtà	descrizione
1	Banco smontato con piano in multiplex 40 mm
1	Armadio L=560 mm con 4 cassetti 1x75 2x150 1x200
1	Coppia squadre di rinforzo
1	Kit 3 montanti biasolati
2	Kit 3 pannelli forati/mensole con 2 bordi fermacasse
6	Gancio Unipok per utensili - confezione 30 pezzi
4	Barra aggancio per contenitori Picking Box mis. 1/2
4	Kit 4 contenitori Picking Box Air mis. 1



ART.	L mm	P mm	H mm	RAL	€
MASTERBR2009	2000	750	1683/2058	7035+7016	1604,70

Composto da:

qtà	descrizione
1	Banco smontato con piano in multiplex 40 mm
1	Armadio L=560 mm predisposto per porta con 1 piano regolabile
1	Porta totale sinistra H=600 mm con maniglia Dark Grey
1	Armadio L=560 mm con 4 cassetti 1x75 2x150 1x200
2	Semipiano aggiuntivo L=560 mm
1	Kit 3 montanti biasolati
2	Kit 3 pannelli forati/mensole con 2 bordi fermacasse
6	Gancio Unipok per utensili - confezione 30 pezzi
4	Barra aggancio per contenitori Picking Box mis. 1/2
4	Kit 4 contenitori Picking Box Air mis. 1



PORTATA

RAL 7035 + RAL 7016



1000 kg

regolabili in altezza

piano in multiplex spessore 40 mm

Forniti smontati

passo fori gambe 25 mm



ART.	L mm	P mm	H mm	RAL	€
MASTERBR2002	2000	750	740/1115	7035+7016	1593,90

Composto da:

qtà	descrizione
1	Banco smontato con piano in multiplex 40 mm
1	Armadio L=560 mm con 4 cassetti 1x75 2x150 1x200
1	Armadio L=560 mm con 5 cassetti 1x75 3x100 1x200
2	Semipiano aggiuntivo L=560 mm



CONFIGURE



ART.	L mm	P mm	H mm	RAL	€
MASTERBR2003	2000	750	740/1115	7035+7016	1398,30

Composto da:

qtà	descrizione
1	Banco smontato con piano in multiplex 40 mm
1	Armadio L=560 mm con 5 cassetti 1x75 3x100 1x200
4	Piano superiore/inferiore L=560 mm
1	Porta totale destra H=600 mm con maniglia Dark Grey
1	Porta totale sinistra H=600 mm con maniglia Dark Grey
2	Supporto semipiano intermedio
2	Piano interno L=558 mm
2	Pannello forato laterale



CONFIGURE



ART.	L mm	P mm	H mm	RAL	€
MASTERBR2004	2000	750	740/1115	7035+7016	1434,60

Composto da:

qtà	descrizione
1	Banco smontato con piano in multiplex 40 mm
3	Armadio L=560 mm predisposto per porta con 1 cassetto H=150 mm
1	Porta parziale destra H=435 mm con maniglia Dark Grey
2	Porta parziale sinistra H=435 mm con maniglia Dark Grey



CONFIGURE

ESEMPI DI CONFIGURAZIONE

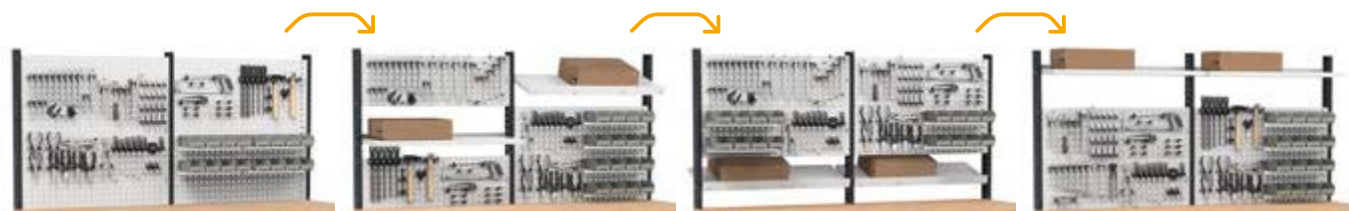

Utensili esclusi



CONFIGURE



ART.	L mm	P mm	H mm	RAL	€
MASTERBR2010	2000	750	1683/2058	7035+7016	1962,60

Composto da:

qtà	descrizione
1	Banco smontato con piano in multiplex 40 mm
1	Armadio L=560 mm con 5 cassetti 1x75 3x100 1x200
1	Armadio L=560 mm con 4 cassetti 1x75 2x150 1x200
2	Semipiano aggiuntivo L=560 mm
1	Kit 3 montanti biasolati
2	Kit 3 pannelli forati/mensole con 2 bordi fermacasse
6	Gancio Unipok per utensili - confezione 30 pezzi
4	Barra aggancio per contenitori Picking Box mis. 1/2
4	Kit 4 contenitori Picking Box Air mis. 1



Utensili esclusi



CONFIGURE



ART.	L mm	P mm	H mm	RAL	€
MASTERBR2011	2000	750	1683/2058	7035+7016	1767,00

Composto da:

qtà	descrizione
1	Banco smontato con piano in multiplex 40 mm
4	Piano superiore/inferiore L=560 mm
1	Porta totale sinistra H=600 mm con maniglia Dark Grey
1	Porta totale destra H=600 mm con maniglia Dark Grey
2	Piano interno L=558 mm
2	Supporto semipiano intermedio
1	Armadio L=560 mm con 5 cassetti 1x75 3x100 1x200
2	Pannello forato laterale
1	Kit 3 montanti biasolati
2	Kit 3 pannelli forati/mensole con 2 bordi fermacasse
6	Gancio Unipok per utensili - confezione 30 pezzi
4	Barra aggancio per contenitori Picking Box mis. 1/2
4	Kit 4 contenitori Picking Box Air mis. 1



Utensili esclusi



CONFIGURE



ART.	L mm	P mm	H mm	RAL	€
MASTERBR2012	2000	750	1683/2058	7035+7016	1803,30

Composto da:

qtà	descrizione
1	Banco smontato con piano in multiplex 40 mm
3	Armadio L=560 mm predisposto per porta con 1 cassetto H=150 mm
2	Porta parziale sinistra H=435 mm con maniglia Dark Grey
1	Porta parziale destra H=435 mm con maniglia Dark Grey
1	Kit 3 montanti biasolati
2	Kit 3 pannelli forati/mensole con 2 bordi fermacasse
6	Gancio Unipok per utensili - confezione 30 pezzi
4	Barra aggancio per contenitori Picking Box mis. 1/2
4	Kit 4 contenitori Picking Box Air mis. 1



PORTATA

RAL 7035 + RAL 7016

WORK MASTER BR

COMPONENTI

 1000 kg



regolabili in altezza

 piano in multiplex spessore 40 mm

 Forniti smontati



passo fori gambe 25 mm



ART.	L mm	P mm	H mm	piano		RAL	€
				materiale	mm		
MBR01S0V0V001PD	1024	750	740/1115	Multiplex	40	7035+7016	270,60

[CONFIGURE](#) 

[SHOP](#) 



ART.	L mm	P mm	H mm	piano		RAL	€
				materiale	mm		
MBR02S0V0V001PD	1500	750	740/1115	Multiplex	40	7035+7016	315,30

[CONFIGURE](#) 

[SHOP](#) 



ART.	L mm	P mm	H mm	piano		RAL	€
				materiale	mm		
MBR03S0V0V001PD	2000	750	740/1115	Multiplex	40	7035+7016	369,90

[CONFIGURE](#) 

[SHOP](#) 



ART.	L mm	P mm	H mm	piano		RAL	€
				materiale	mm		
MBR04S0V0V001PD	3000	750	740/1115	Multiplex	40	7035+7016	650,70

[CONFIGURE](#) 

[SHOP](#) 



IMBALLO BANCO SMONTATO



COPIA SQUADRE DI RINFORZO

ART.	L mm	P mm	H mm	RAL	€
FBGKITS0008	145	39	145	7035	17,10

 Utilizzare una squadra per gamba se non è presente la cassettera o il piano (una coppia per banchi 1024/1500/2000, due coppie per banchi 3000)

[SHOP](#) 

WORK MASTER BR

COMPONENTI



COPERTURA PER PIANO IN MULTIPLEX

ART.	Lmm	Pmm	Hmm	€
FBL22300007	1028	754	22	82,80
FBL22600007	1504	754	22	114,60
FBL22900007	2004	754	22	146,40
FBL23200007	3004	754	22	274,20

SCHEMA TECNICO

L → 1000 mm



L → 1500 mm

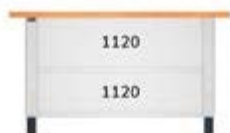

L → 2000 mm



L → 3000 mm



PORTATA



SPESORE



RAL 7035 + RAL 7016



RAL 7035

WORK MASTER BR

COMPONENTI



ARMADI CON CASSETTI

L  560 mm

27X27 EH

ARMADIO CON 3 CASSETTI





ART.	L mm	P mm	H mm	cassetti					RAL	€
				n.	h 75 mm	h 100 mm	 KG			
MBR05SC010203PD	560	610	369	3	1	2	100-75-50	92-96-100%	7035+7016	463,80

[SHOP](#) 



ARMADIO CON 4 CASSETTI





ART.	L mm	P mm	H mm	cassetti					RAL	€	
				n.	h 75 mm	h 150 mm	h 200 mm	 KG			
MBR05SC010204PD	560	610	669	4	1	2	1	100-75-50	92-96-100%	7035+7016	541,20

[SHOP](#) 



ARMADIO CON 5 CASSETTI



ART.	L mm	P mm	H mm	cassetti					RAL	€	
				n.	h 75 mm	h 100 mm	h 200 mm	 KG			
MBR05SC010205PD	560	610	669	5	1	3	1	100-75-50	92-96-100%	7035+7016	624,00

[SHOP](#) 



ARMADIO CON PIANO INTERMEDIO PREDISPOSTO PER PORTE



ART.	Lmm	Pmm	Hmm	piano regolabile	RAL	€
MBR05SX00020708	560	610	669	1	7035	210,60

[SHOP](#) 

PORTA TOTALE SINISTRA H=600 MM CON MANIGLIA DARK GREY



ART.	Lmm	Pmm	Hmm	apertura	RAL	€
MBR06SC01020239	504	34	600	Sinistra	7016	55,50

[SHOP](#) 

PORTA TOTALE DESTRA H=600 MM CON MANIGLIA DARK GREY



ART.	Lmm	Pmm	Hmm	apertura	RAL	€
MBR06SC01020139	504	34	600	Destra	7016	55,50

[SHOP](#) 

WORK MASTER BR

COMPONENTI

ARMADI CON CASSETTI

L → 560 mm

27X27 EH



ARMADIO TECNICO L=560 MM PREDISPOSTO PER PORTA
Adatto per porte Art. MBR06SC01020339 e Art. MBR06SC01020439

ART.	L mm	P mm	H mm	RAL	€
MBR05SX000208PD	560	610	669	7035+7016	233,70



ARROTOLATORE ELETTRICO CON PRESA SCHUKO

ART.	L cavo m	tipo presa	Volt	Watt	€
MBR13S0V0V00100	20	Schuko	230	1600	533,10



ARROTOLATORE PER ARIA COMPRESSA

ART.	L cavo m	Pressione max Mpa	Ø mm	€
MBR13S0V0V00200	14	1,5	10	244,80



RULLO PER ARROTOLATORE

ART.	€
MBR13S0V0V00339	29,10



PIASTRA PER ARROTOLATORE
Da fissare alla parte posteriore dell'armadio

ART.	€
MBR13S0V0V00499	20,70



1. Armadio tecnico L=560 mm predisposto per porta
2. Modulo: Rullo per arrotolatore

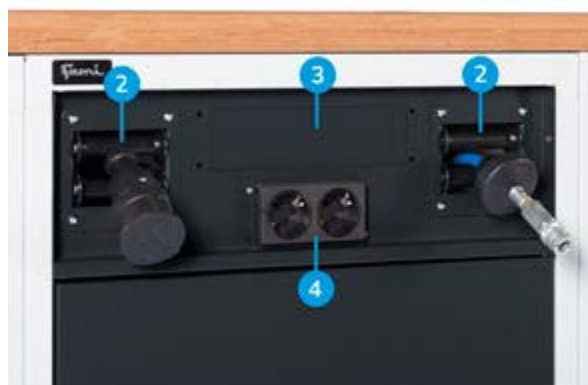

3. Modulo: Multipresa a 4 scomparti
4. Modulo: Multipresa a 2 scomparti



PORTATA



ESTRAZIONE



RAL 7035 + RAL 7016



RAL 7016



RAL 7035

WORK MASTER BR

COMPONENTI

ARMADI CON CASSETTI

L → 560 mm

27X27 EH



ARMADIO L=560 MM PREDISPOSTO PER PORTA CON 1 CASSETTO H=150 MM

ART.	L mm	P mm	H mm	cassetti			RAL	€
				h 150 mm				
MBR05SC010206PD	560	610	669	1	100-75-50	92-96-100%	7035+7016	302,40



PORTA PARZIALE SINISTRA H=435 MM CON MANIGLIA DARK GREY

ART.	L mm	P mm	H mm	apertura	RAL	€
MBR06SC01020439	504	34	435	Sinistra	7016	52,50



PORTA PARZIALE DESTRA H=435 MM CON MANIGLIA DARK GREY

ART.	L mm	P mm	H mm	apertura	RAL	€
MBR06SC01020339	504	34	435	Destra	7016	52,50



ARMADI CON CASSETTI

L → 713 mm

36X27 EH



ARMADIO L=713 MM CON 4 CASSETTI 1X75 2X150 1X200

ART.	L mm	P mm	H mm	cassetti					RAL	€	
				n.	h 75 mm	h 150 mm	h 200 mm				
MBR05SC010304PD	713	610	669	4	1	2	1	100-75-50	92-96-100%	7035+7016	573,00



ARMADIO L=713 MM CON 5 CASSETTI 1X75 3X100 1X200

ART.	L mm	P mm	H mm	cassetti					RAL	€	
				n.	h 75 mm	h 100 mm	h 200 mm				
MBR05SC010305PD	713	610	669	5	1	3	1	100-75-50	92-96-100%	7035+7016	649,50



WORK MASTER BR

COMPONENTI

ARMADI CON CASSETTI

L → 713 mm

36X27 EH



ARMADIO L=713 MM PREDISPOSTO PER PORTA CON 1 PIANO REGOLABILE

ART.	L mm	P mm	H mm	RAL	€
MBR05SX00030708	713	610	669	7035	226,50

[SHOP](#)



PORTA TOTALE SINISTRA H=600 MM CON MANIGLIA DARK GREY

ART.	L mm	P mm	H mm	apertura	RAL	€
MBR06SC01030239	657	34	600	Sinistra	7016	58,80

[SHOP](#)



PORTA TOTALE DESTRA H=600 MM CON MANIGLIA DARK GREY

ART.	L mm	P mm	H mm	apertura	RAL	€
MBR06SC01030139	657	34	600	Destra	7016	58,80

[SHOP](#)



ARMADIO L=713 MM PREDISPOSTO PER PORTA CON 1 CASSETTO H=150 MM

ART.	L mm	P mm	H mm	cassetti			RAL	€
				h 150 mm				
MBR05SC010306PD	713	610	669	1	100-75-50	92-96-100%	7035+7016	319,50

[SHOP](#)



PORTA PARZIALE SINISTRA H=435 MM CON MANIGLIA DARK GREY

ART.	L mm	P mm	H mm	apertura	RAL	€
MBR06SC01030439	657	34	435	Sinistra	7016	55,50

[SHOP](#)



PORTA PARZIALE DESTRA H=435 MM CON MANIGLIA DARK GREY

ART.	L mm	P mm	H mm	apertura	RAL	€
MBR06SC01030339	657	34	435	Destra	7016	55,50

[SHOP](#)



PORTATA



ESTRAZIONE



RAL 7035 + RAL 7016



RAL 7016



RAL 7035

WORK MASTER BR

COMPONENTI







PANNELLO FORATO LATERALE

ART.	L mm	P mm	H mm	Dim. foro mm	RAL	€
 FBG15S00V0V0008	610	75	669	10x10	7035	44,70









PIANO AGGIUNTIVO

ART.	L mm	P mm	H mm	 KG	RAL	€
 MBR08S070600008	713	605	35	250	7035	43,20
 MBR08S090600008	967	605	35	250	7035	54,00
 MBR08S110600008	1120	605	35	250	7035	54,00
 MBR08S120600008	1273	605	35	250	7035	57,30
 MBR08S160600008	1680	605	35	200	7035	72,60



SEMIPIANO AGGIUNTIVO

ART.	L mm	P mm	H mm	 KG	RAL	€
 MBR09S050300008	560	305	35	100	7035	29,40
 MBR09S070300008	713	305	35	100	7035	29,40
 MBR09S090300008	967	305	35	100	7035	33,60
 MBR09S110300008	1120	305	35	100	7035	33,60
 MBR09S120300008	1273	305	35	100	7035	38,40
 MBR09S160300008	1680	305	35	100	7035	46,50



SUPPORTO SEMIPIANO INTERMEDIO

ART.	L mm	P mm	H mm	RAL	€
 FBG13S605V00008	605	77	35	7035	9,60

WORK MASTER BR

COMPONENTI

MODULO COMPONIBILE



SHOP

PIANO INTERNO 27X27 EH

ART.	L mm	P mm	H mm	KG	RAL	€
MBR11S0V0020008	558	466	60	100	7035	28,20



SHOP

PIANO SUPERIORE E INFERIORE 27X27 EH

ART.	L mm	P mm	H mm	KG	RAL	€
MBR10S050600008	560	610	32	100	7035	32,10

1. Piano interno 27x27 EH
2. Piano superiore e inferiore 27x27 EH
3. Supporto semipiano intermedio
4. Porta totale destra H=600 mm con maniglia Dark Grey
5. Porta totale sinistra H=600 mm con maniglia Dark Grey



SHOP

PORTA TOTALE DESTRA H=600 MM CON MANIGLIA DARK GREY

ART.	L mm	P mm	H mm	apertura	RAL	€
MBR06SC01020539	554	34	600	Destra	7016	55,50



SHOP

SUPPORTO SEMIPIANO INTERMEDIO

ART.	L mm	P mm	H mm	RAL	€
FBG13S605V00008	605	77	35	7035	9,60



SHOP

PORTA TOTALE SINISTRA H=600 MM CON MANIGLIA DARK GREY

ART.	L mm	P mm	H mm	apertura	RAL	€
MBR06SC01020639	554	34	600	Sinistra	7016	55,50



PORTATA



RAL 7016



RAL 7035

MATERIALE DI SEPARAZIONE

L ➔ 560 mm



ART.	adatto per cassetto H mm	componenti	€
FFH84050200	50/300	16 x Divisorio trasversale L=36 mm 7 x Divisorio trasversale L=47 mm 6 x Divisorio a 3 canali 3 x Divisorio a 4 canali	21,90



ART.	adatto per cassetto H mm	componenti	€
FFH84050300	50/300	15 x Divisorio trasversale L=47 mm 8 x Divisorio trasversale L=73 mm 6 x Divisorio a 2 canali 3 x Divisorio a 3 canali	21,90



ART.	adatto per cassetto H mm	componenti	€
FFH84050400	50/300	18 x Divisorio trasversale L=73 mm 9 x Divisorio a 2 canali	21,00



ART.	adatto per cassetto H mm	componenti	€
FFH84071800	75	6 x Cassetta divisorio 150x75 mm 6 x Cassetta divisorio 150x150 mm	22,50
FFH84101800	100/125		24,60



ART.	adatto per cassetto H mm	componenti	€
FFH84070800	75	2 x Divisorio longitudinale fessurato L=457 mm 3 x Divisorio trasversale L=151 mm	12,90
FFH84100800	100/125		15,90
FFH84150800	150/175		20,40
FFH84200800	200/250		29,70

MATERIALE DI SEPARAZIONE

L ➔ 713 mm



ART.	adatto per cassetto H mm	componenti	€
FFH10051000	50/300	3 x Divisorio a 3 canali 9 x Divisorio a 4 canali 12 x Divisorio trasversale L=47 mm 36 x Divisorio trasversale L=36 mm	30,90



ART.	adatto per cassetto H mm	componenti	€
FFH10051300	50/300	18 x Divisorio trasversale L=47 mm 12 x Divisorio trasversale L=73 mm 6 x Divisorio a 2 canali 6 x Divisorio a 3 canali	27,90



ART.	adatto per cassetto H mm	componenti	€
FFH10051500	50/300	20 x Divisorio trasversale L=36 mm 20 x Divisorio trasversale L=47 mm 6 x Divisorio a 3 canali 5 x Divisorio a 4 canali 1 x Porta chiavi a brugola	30,90



ART.	adatto per cassetto H mm	componenti	€
FFH10071800	75	16 x Cassetta divisorio 75x75 mm 8 x Cassetta divisorio 150x75 mm 4 x Cassetta divisorio 150x150 mm	31,50



ART.	adatto per cassetto H mm	componenti	€
FFH10071600	75	12 x Cassetta divisorio 150x75 mm 6 x Cassetta divisorio 150x150 mm	28,80
FFH10101600	100/125		33,60



ART.	adatto per cassetto H mm	componenti	€
FFH10070500	75	2 x Divisorio longitudinale fessurato L=457 mm 3 x Divisorio trasversale L=202 mm	15,90
FFH10100500	100/125		16,50
FFH10150500	150/175		21,90
FFH10200500	200/250		31,20

WORK MASTER BR



CONFIGURE

SHOP

PATENTED

ART.	L mm	P mm	H mm	KG	RAL	€
MASTERBR3001	3206	750	1985/2360	1000	7035+7016	4673,70

Composto da:

qtà	descrizione	qtà	descrizione
1	Banco smontato con piano in multiplex 40 mm	1	Tasca porta documenti A4
1	Armadio L=560 mm predisposto per porta con 1 piano regolabile	1	Kit porta rotolo con carta Ø=240 mm
2	Armadio L=713 mm con 4 cassetti 1x75 2x150 1x200	4	Porta bombolette inclinato a 2 posti
1	Armadio tecnico L=560 mm predisposto per porta	6	Gancio Unipok per utensili - confezione 30 pezzi
1	Porta parziale destra H=435 mm con maniglia Dark Grey	1	Barra aggancio per contenitori Picking Box mis. 1/2
1	Porta totale sinistra H=600 mm con maniglia Dark Grey	1	Kit 4 contenitori Picking Box Air mis. 1
2	Pannello forato laterale	2	Mensola grande reversibile
1	Kit 3 montanti biasolati	1	Cestino capacità 30 L
2	Kit 3 pannelli forati/mensole con 2 bordi fermacasse	3	Kit 2 contenitori Picking Box Air mis. 3A2
2	Lampada doppia	1	Piastra per arrotolatore
2	Pensile con porta	2	Rullo per arrotolatore
1	Multipresa schuko a 2 scomparti	1	Arrotolatore per aria compressa
1	Cavo di collegamento wieland schuko/francese	1	Arrotolatore elettrico con presa Schuko
1	Kit 3 supporti inclinati con 2 binari		



WORK MASTER BR



CONFIGURE

SHOP

PATENTED*

ART.	L mm	P mm	H mm		RAL	€
MASTERBR1508	1706	750	1985/2360	1000	7035+7016	2136,30

Composto da:

qtà	descrizione	qtà	descrizione
1	Banco smontato con piano in multiplex 40 mm	1	Cavo di collegamento wieland schuko/francese
1	Armadio L=560 mm con 5 cassetti 1x75 3x100 1x200	1	Tasca porta documenti A4
2	Piano superiore/inferiore L=560 mm	1	Kit porta rotolo con carta Ø=240 mm
1	Porta totale sinistra H=600 mm con maniglia Dark Grey	2	Porta bombolette inclinato a 2 posti
1	Supporto semipiano intermedio	4	Gancio Unipok per utensili - confezione 30 pezzi
1	Piano interno L=558 mm	1	Cestino capacità 30 L
2	Pannello forato laterale	2	Pensile con porta
1	Supporto multipresa a 2 scomparti	1	Lampada doppia
1	Supporto multipresa a 4 scomparti	1	Kit 3 pannelli forati/mensole con 2 bordi fermacasse
1	Multipresa schuko a 2 scomparti	1	Kit 2 supporti inclinati con binario
1	Multipresa schuko a 4 scomparti	1	Kit 2 montanti biasolati

PORTATA

RAL 7035 + RAL 7016

DYNAMIC

BANCHI DA LAVORO SERIE PRO+

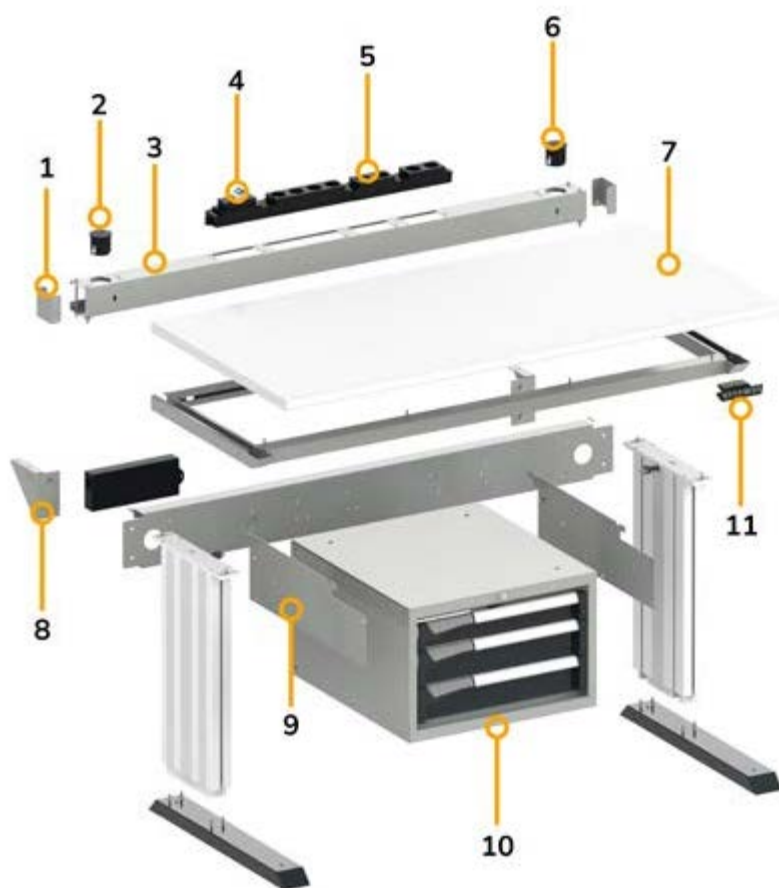

- | | | |
|-------------------|----------------------|------------------------|
| 1. Tampone | 5. Multiprese | 9. Supporto |
| 2. USB Dati | 6. USB Ricarica | 10. Armadio a cassette |
| 3. Telaio | 7. Piano in laminato | 11. Tastierino |
| 4. Magnetotermico | 8. Angolare | |

La postazione di lavoro Dynamic è una soluzione dinamica ed ergonomica con **gambe regolabili in altezza elettronicamente** tramite un pratico tastierino con 3 memorie di posizionamento. È disponibile con larghezza 985 e 1470 mm ed è dotato di un **piano di lavoro in laminato**. La componentistica elettrica può essere installata nel traverso di serie o nel telaio aggiuntivo che consente anche il fissaggio dei montanti per parete attrezzata. Dynamic può essere personalizzato con armadi a cassette e con **prodotti per l'ESD** quali tappeti e prese di messa a terra per poter essere impiegato anche per la lavorazione di componenti elettroniche.



**PORTATA BANCO 400
KG**

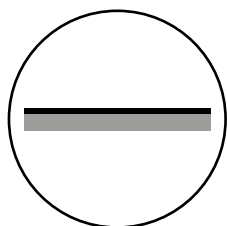

PIANO IN LAMINATO

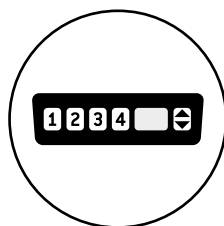

**TASTIERINO CON 3
MEMORIE**

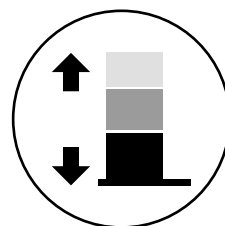

**REGOLABILE IN
ALTEZZA
ELETTRONICAMENTE**



CONFIGURE

SHOP



ART.	L mm	P mm	H mm	KG	RAL	€
DYNAMIC1504	1497	780	740/1140	400	7035+7016	2671,20

Composto da:

qtà	descrizione	qtà	descrizione
1	Banco smontato regolabile elettricamente	1	Multipresa schuko a 4 scomparti
1	Armadio L=560 mm con 3 cassetti 1x75 2x100	1	Magnetotermico differenziale
1	Telaio portaprese aggiuntivo completo di tamponi e angolari	1	Cavo di collegamento wieland con spine in/out
1	Coppia supporti per armadio	1	Cavo di collegamento wieland schuko/francese
2	Multipresa schuko a 2 scomparti	1	Presse usb dati
		1	Presse usb ricarica



PORTATA



RAL 7035 + RAL 7016



CONFIGURE

SHOP

PATENTED

ART.	L mm	P mm	H mm	KG	RAL	€
DYNAMIC1501	1497	780	1983/2383	400	7035+7016	3490,50

Composto da:

qtà	descrizione	qtà	descrizione
1	Banco smontato regolabile elettricamente	2	Lampada singola
1	Armadio L=560 mm con 3 cassetti 1x75 2x100	1	Binario supplementare con attacchi
2	Pannello forato/mensola con 1 bordo fermacasse	1	Presse usb ricarica
1	Kit 2 montanti biasolati	1	Presse usb dati
1	Kit 2 supporti inclinati con binario	1	Cavo di collegamento wieland schuko/francese
1	Pannello forato Electric	1	Magnetotermico differenziale
1	Lampada doppia	1	Multiprese schuko a 4 scomparti
1	Coppia supporti per armadio	2	Multiprese schuko a 2 scomparti
1	Telaio portaprese aggiuntivo completo di tamponi e angolari	36	Contenitore in polipropilene Picking Box Air mis. 2



ART.	L mm	P mm	H mm	KG	RAL	€
DYNAMIC1503	1497	780	1983/2383	400	7035+7016	3361,50

Composto da:

qtà	descrizione
1	Banco smontato regolabile elettricamente
1	Armadio L=500 mm con 1 cassetto H=150 mm
1	Binario supplementare con attacchi
1	Pannello forato/mensola
2	Pannello forato/mensola con 1 bordo fermacasse
1	Kit 2 montanti biasolati
1	Kit 2 supporti inclinati con binario
1	Mensola porta oggetti reversibile
1	Gancio Unipok per utensili - confezione 30 pezzi
1	Coperchio per armadio L=500 mm
2	Multipresa schuko a 2 scomparti
1	Multipresa schuko a 4 scomparti
1	Magnetotermico differenziale
1	Cavo di collegamento wieland schuko/francese
1	Presse usb dati
1	Presse usb ricarica
1	Pannello forato Electric
1	Lampada doppia
3	Lampada singola
1	Telaio portaprese aggiuntivo completo di tamponi e angolari
1	Coppia supporti per armadio
36	Contenitore in polipropilene Picking Box Air mis. 2



ART.	L mm	P mm	H mm	KG	RAL	€
DYNAMIC1502	1497	780	1983/2383	400	7035+7016	3081,60

Composto da:

qtà	descrizione
1	Banco smontato regolabile elettricamente
2	Pensile con porta
1	Binario supplementare con attacchi
2	Pannello forato/mensola con 1 bordo fermacasse
1	Kit 2 montanti biasolati
1	Kit 2 supporti inclinati con binario
1	Pannello forato Electric
1	Multipresa schuko a 4 scomparti
1	Magnetotermico differenziale
1	Cavo di collegamento wieland schuko/francese
1	Presse usb dati
1	Presse usb ricarica
1	Mensola porta oggetti reversibile
1	Lampada doppia
1	Lampada singola
1	Telaio portaprese aggiuntivo completo di tamponi e angolari
2	Multipresa schuko a 2 scomparti
6	Kit 3 contenitori Picking Box Air mis. 2



PORTATA



RAL 7035 + RAL 7016

DYNAMIC

COMPONENTI

L ➔ 1000 - 1500 mm

 400 kg

 regolabili in altezza

 Forniti smontati



BANCO BASE CON TRAVERSO REVERSIBILE



ART.	L mm	P mm	H mm	RAL	€
FLE0970E0PD	985	700	740/1140	7035+7016	1486,80
FLE1470E0PD	1470	700	740/1140	7035+7016	1589,40

1. Traverso reversibile



Il banco è dotato di gambe regolabili in altezza elettronicamente. L'altezza può variare da un minimo di 740 mm a un massimo di 1140 mm.



Il tastierino numerico consente di controllare il meccanismo di regolazione del banco. Oltre a consentire di modificare l'altezza del piano di lavoro, è dotato anche di 3 memorie di posizionamento per modificare rapidamente l'altezza del banco in base all'utilizzatore.

VISTA ANTERIORE DEL TRAVERSO



VISTA POSTERIORE DEL TRAVERSO



Il traverso del banco presenta delle incisioni per la collocazione delle prese elettriche e degli interruttori magnetotermici Iron Team Electric. In base alla dimensione scelta, il numero di intagli varia. I diversi componenti possono essere installati sia nella parte posteriore che anteriore del traverso. Gli Iron Team Electric non sono compresi con il traverso.

SCHEMA PRESE TRAVERSO

1000



① ② ③ ⑤ ①

1500



① ② ③ ④ ⑤ ①

① foro per cavi ② magnetotermico ③ multipresa 2 scomparti ④ multipresa 4 scomparti ⑤ centralina

DYNAMIC

COMPONENTI

L ➤ 1000 - 1500 mm

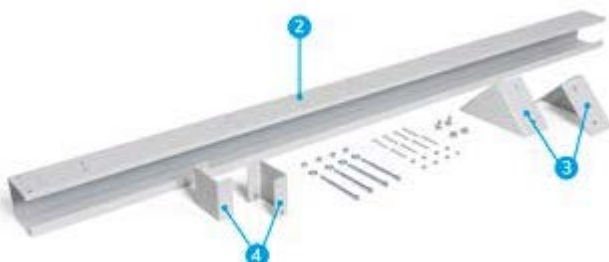

1. Traverso reversibile
2. Telaio
3. Angolari
4. Tamponi

TELAIO PORTAPRESE AGGIUNTIVO COMPLETO DI TAMPONI E ANGOLARI

ART.	L mm	P mm	H mm	RAL	€
FBL46600008	1014	130	208	7035	63,60
FBL46650008	1499	130	208	7035	70,20



VISTA SUPERIORE DEL TELAIIO



VISTA INFERIORE DEL TELAIIO

Per il montaggio del montante Work Look è necessaria l'installazione del telaio aggiuntivo.

Il telaio reversibile per banco presenta delle incisioni per la collocazione delle prese elettriche e degli interruttori magnetotermici Iron Team Electric. In base alla dimensione scelta, il numero di intagli varia. I diversi componenti possono essere installati sia nella parte superiore che inferiore del telaio reversibile. Gli Iron Team Electric non sono compresi con il telaio aggiuntivo.

SCHEMA PRESE TELAIIO

1000



- 1 2 4 3 3 5

1500



- 1 2 4 3 3 1

- 1 USB dati 2 magnetotermico 3 multipresa 2 scomparti 4 multipresa 4 scomparti 5 USB ricarica



PORTATA



RAL 7035 + RAL 7016



RAL 7035



ARMADIO CON 3 CASSETTI



ART.	L mm	P mm	H mm	cassetti				RAL	€	
				n.	h 75 mm	h 100 mm	KG			
MBR05SC010203PD	560	610	369	3	1	2	100-75-50	92-96-100%	7035+7016	463,80

ARMADIO CON 1 CASSETTO



ART.	L mm	P mm	H mm	cassetti			RAL	€	
				n.	KG				h mm
FBG03S50C0001PD	500	630	210	1	80	86%	150	7035+7016	103,50



COPERCHIO PER ARMADIO L=500 MM

Per armadio ad 1 cassetto



ART.	L mm	P mm	H mm	RAL	€
FBL66900008	496	601	2	7035	28,80



COPPIA SUPPORTI PER ARMADIO



ART.	L mm	P mm	H mm	RAL	€
FBL46010008	2	648	181	7035	22,50

IRONTEAM ELECTRIC



FBLET012007



FBLET004007



FBLET005007



FBLET016007



FBLET013007



FBLET020007



FBLET019007

vedi pag. 196

DYNAMIC

COMPONENTI



Il banco regolabile in altezza elettronicamente Dynamic consente di creare una postazione di lavoro dinamica ed ergonomica, adatta all'impiego in numerosi settori. Per massimizzare il comfort dell'utilizzatore Dynamic offre numerose soluzioni: armadi con cassetti, telai aggiuntivi o traversi per componenti elettrici, pareti forate Work Look. Le gambe regolabili in altezza sono controllate da un pratico tastierino numerico. L'altezza del banco può essere regolata al millimetro da un minimo di 740 mm ad un massimo di 1140 mm. Consente di memorizzare tre altezze diverse per regolare in velocità e semplicità il piano di lavoro in poche mosse.

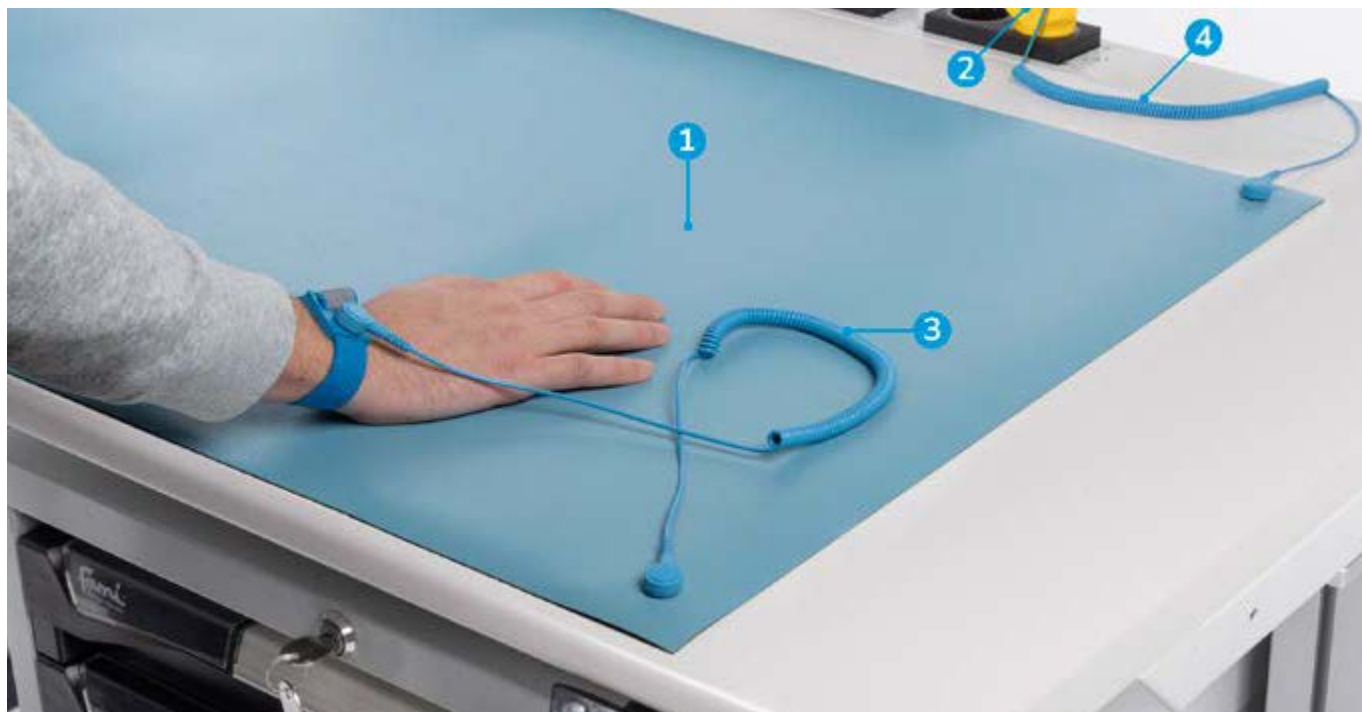

1. Tappeto ESD a 2 strati
2. Spina schuko ESD
3. Cinturino regolabile con bottoni completo di cavetto
4. Cavetto con bottoni

TAPPETO ESD A 2 STRATI

ART.	L mm	P mm	H mm	€
FAXTAPPIER120XB	900	600	2	105,00



SPINA SCHUKO ESD

ART.	L mm	P mm	H mm	€
FAXSCHUKOESD005	52	52	72	24,00



CINTURINO REGOLABILE CON BOTTONI COMPLETO DI CAVETTO

ART.	L cavo m	€
FAXITE780419304	2,5	9,90



CAVETTO CON BOTTONI

ART.	L mm	€
FAXITE7804885XB	2500	6,60



PORTATA



ESTRAZIONE



RAL 7035 + RAL 7016



RAL 7035

WORK LOOK

PANNELLI FORATI SERIE PRO

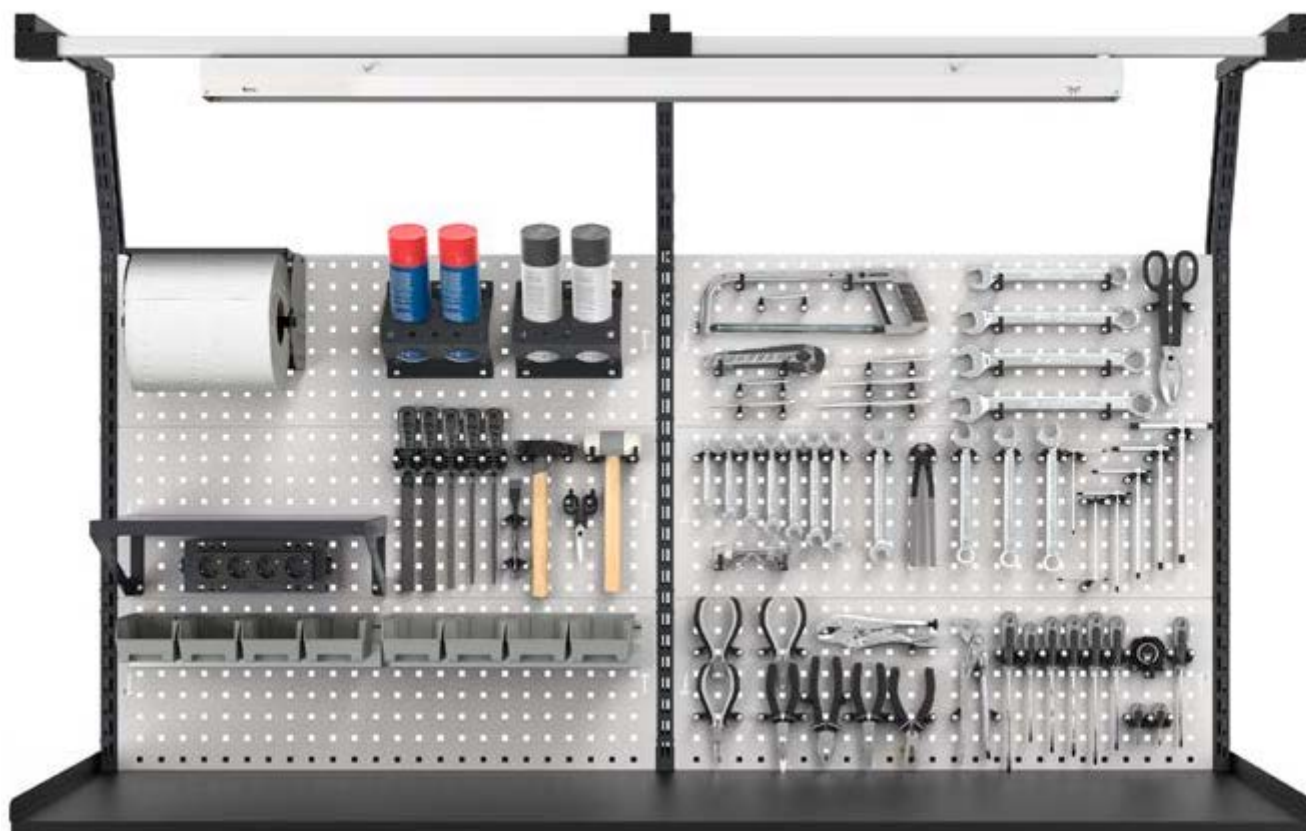

I **pannelli forati** Work Look con foro **10x10** mm possono essere posizionati su banchi da lavoro, carrelli, pareti in legno o muri per creare pareti porta attrezzi di diverse dimensioni. Se installato su montanti per banchi da lavoro, l'utente potrà scegliere se impiegare il pannello come **parete porta utensili** oppure come **mensola orizzontale o inclinata** con bordo fermacasse. Work Look può ospitare una vasta gamma di componenti: da strutture aree e lampade, fino a pensili vasistas, accessori e ganci.

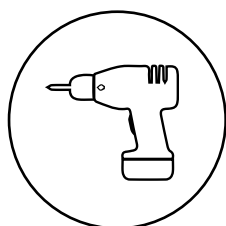

FISSAGGIO A MURO

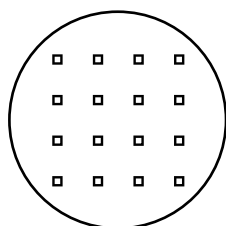

FORI QUADRI
10X10

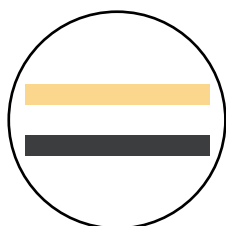

ADATTE PER PIANI
IN LEGNO E
ACCIAIO

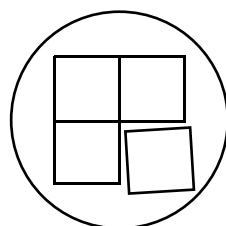

MODULARI

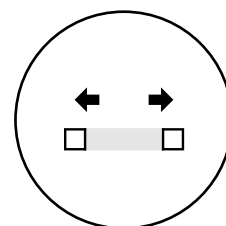

PASSO 38 MM

WORK LOOK



CONFIGURE

SHOP

PATENTED*

ART.	L mm	P mm	H mm	KG	RAL	€
MASTERBR1507	1706	750	1985/2360	1000	7035+7016	2304,00

Composto da:

qtà	descrizione	qtà	descrizione
1	Banco smontato con piano in multiplex 40 mm	1	Kit 2 montanti biasolati
1	Armadio L=560 mm con 5 cassette 1x75 3x100 1x200	1	Cestino capacità 30 L
2	Piano superiore/inferiore L=560 mm	1	Mensola grande reversibile
1	Porta totale sinistra H=600 mm con maniglia Dark Grey	1	Barra aggancio per contenitori Picking Box mis. 1/2
1	Piano interno L=558 mm	1	Kit 4 contenitori Picking Box Air mis. 1
1	Supporto semipiano intermedio	3	Gancio Unipok per utensili - confezione 30 pezzi
2	Pannello forato laterale	2	Porta bombolette inclinato a 2 posti
1	Barra led	1	Kit porta rotolo con carta Ø=130 mm
1	Coppia staffe di fissaggio pensile su montanti	1	Tasca porta documenti A4
1	Pensile vasistas senza serratura	1	Cavo di collegamento wieland schuko/francese
1	Lampada doppia	1	Multipresa schuko a 4 scomparti
1	Kit 2 pannelli forati/mensole con 1 bordo fermacasse	1	Multipresa schuko a 2 scomparti
1	Kit 2 supporti inclinati con binario	1	Supporto multipresa a 4 scomparti
		1	Supporto multipresa a 2 scomparti



PORTATA



RAL 7035 + RAL 7016

WORK LOOK

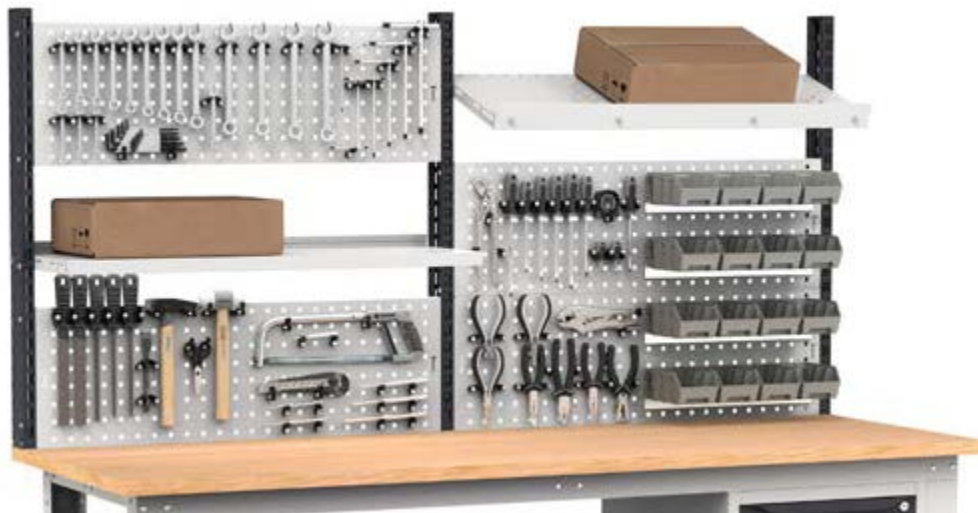

CAMBIA L'ASPETTO DEL TUO BANCO DA LAVORO PER ADATTARLO A DIVERSI UTILIZZI CON WORK LOOK!

In base a come lo installi lo puoi utilizzare come:

pannello forato, mensola orizzontale, mensola inclinata con bordo fermacasse.



ART.	L mm	P mm	H mm	KG montanti	RAL	€
WORKLOOK1001	1015	80	639	50	7035+7016	97,50
WORKLOOK1002	1015	80	639	50	5012	97,50

Composto da:

qtà	descrizione
1	Kit 2 montanti biasolati
1	Kit 2 pannelli forati/mensole con 1 bordo fermacasse



ART.	L mm	P mm	H mm	KG montanti	RAL	€
WORKLOOK1003	1015	80	943	50	7035+7016	137,10
WORKLOOK1004	1015	80	943	50	5012	137,10

Composto da:

qtà	descrizione
1	Kit 2 montanti biasolati
1	Kit 3 pannelli forati/mensole con 2 bordi fermacasse



ART.	L mm	P mm	H mm	KG montanti	RAL	€
WORKLOOK1501	1500	80	639	50	7035+7016	109,20
WORKLOOK1502	1500	80	639	50	5012	109,20

Composto da:

qtà	descrizione
1	Kit 2 montanti biasolati
1	Kit 2 pannelli forati/mensole con 1 bordo fermacasse



ART.	L mm	P mm	H mm	KG montanti	RAL	€
WORKLOOK1503	1500	80	943	50	7035+7016	153,60
WORKLOOK1504	1500	80	943	50	5012	153,60

Composto da:

qtà	descrizione
1	Kit 2 montanti biasolati
1	Kit 3 pannelli forati/mensole con 2 bordi fermacasse

WORK LOOK

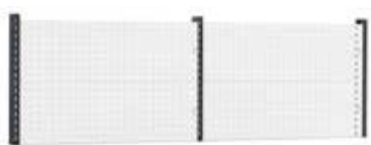

ART.	L mm	P mm	H mm	montanti	RAL	€
WORKLOOK2001	2000	80	639	50	7035+7016	175,80
WORKLOOK2002	2000	80	639	50	5012	175,80

Composto da:

qtà	descrizione
1	Kit 3 montanti biasolati
2	Kit 2 pannelli forati/mensole con 1 bordo fermacasse

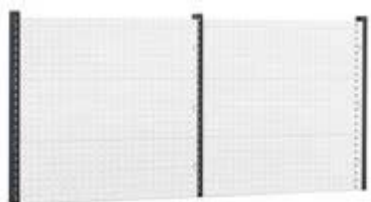

ART.	L mm	P mm	H mm	montanti	RAL	€
WORKLOOK2003	2000	80	943	50	7035+7016	248,10
WORKLOOK2004	2000	80	943	50	5012	248,10

Composto da:

qtà	descrizione
1	Kit 3 montanti biasolati
2	Kit 3 pannelli forati/mensole con 2 bordi fermacasse

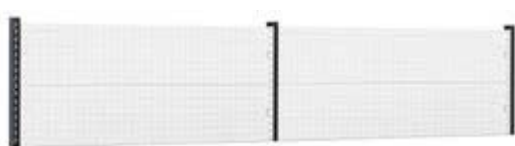

ART.	L mm	P mm	H mm	montanti	RAL	€
WORKLOOK3001	2970	80	639	50	7035+7016	199,20
WORKLOOK3002	2970	80	639	50	5012	199,20

Composto da:

qtà	descrizione
1	Kit 3 montanti biasolati
2	Kit 2 pannelli forati/mensole con 1 bordo fermacasse

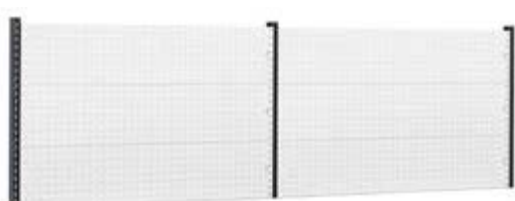

ART.	L mm	P mm	H mm	montanti	RAL	€
WORKLOOK3003	2970	80	943	50	7035+7016	281,10
WORKLOOK3004	2970	80	943	50	5012	281,10

Composto da:

qtà	descrizione
1	Kit 3 montanti biasolati
2	Kit 3 pannelli forati/mensole con 2 bordi fermacasse

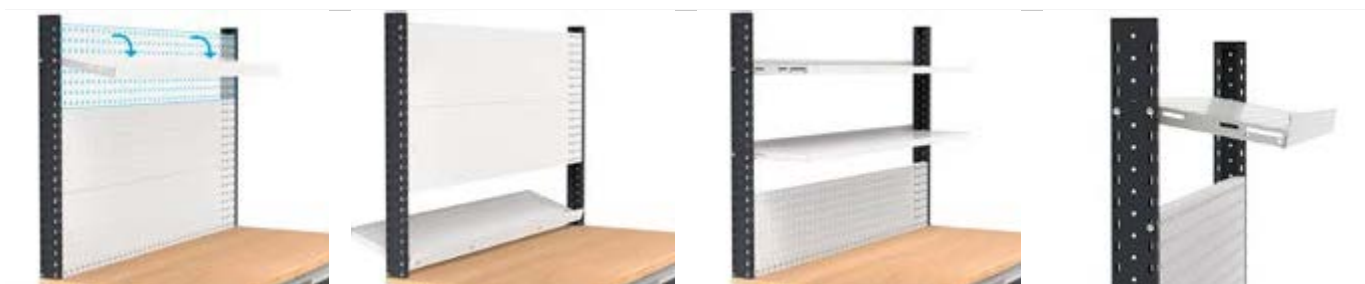

PORTATA



RAL 7035 + RAL 7016



RAL 5012



WORK LOOK

COMPONENTI

PENSILI



PENSILE VASISTAS SENZA SERRATURA

ART.	L mm	P mm	H mm	KG	RAL	€
 FBL8005X000PD	943	350	456	50	7035+7016	309,00
 FBL8005X00004	943	350	456	50	5012	309,00
 FBL8010X000PD	1428	350	456	50	7035+7016	337,50
 FBL8010X00004	1428	350	456	50	5012	337,50



SET DI CHIUSURA PER PENSILE

ART.	€
 FBL8020C00000	11,70



COPPIA STAFFE DI FISSAGGIO PENSILE SU MONTANTI

ART.	L mm	P mm	H mm	RAL	€
 FBL8025000008	33	21	455	7035	24,00
 FBL8025000004	33	21	455	5012	24,00

 Da utilizzare per il fissaggio del pensile ai montanti biasolati



BARRA LED

Senza pulsante on/off

ART.	L mm	temperatura colore K	Watt	Hz	Lumen	€
 FBL99350213	573	4000	10	50/60	1000	45,00
 FBL99400213	873	4000	15	50/60	1500	47,40
 FBL99450213	1173	4000	20	50/60	2000	48,60

WORK LOOK

PENSILI CON MONTANTI E PANNELLI PER BANCHI



ART.	L mm	P mm	H mm	KG montanti	RAL	€
WORKLOOK1005	1015	373	1063	50	7035+7016	466,50
WORKLOOK1006	1015	373	1063	50	5012	466,50

Composto da:

qtà	descrizione
1	Kit 2 montanti biasolati
1	Kit 2 pannelli forati/mensole con 1 bordo fermacasse
1	Pensile vasistas senza serratura
1	Coppia staffe di fissaggio pensile su montanti
2	Gancio Unipok per utensili - confezione 30 pezzi



ART.	L mm	P mm	H mm	KG montanti	RAL	€
WORKLOOK1505	1500	373	1063	50	7035+7016	526,50
WORKLOOK1506	1500	373	1063	50	5012	526,50

Composto da:

qtà	descrizione
1	Kit 2 montanti biasolati
1	Kit 2 pannelli forati/mensole con 1 bordo fermacasse
1	Pensile vasistas senza serratura
1	Coppia staffe di fissaggio pensile su montanti
2	Gancio Unipok per utensili - confezione 30 pezzi
2	Barra aggancio per contenitori Picking Box mis. 1/2
2	Kit 4 contenitori Picking Box Air mis. 1

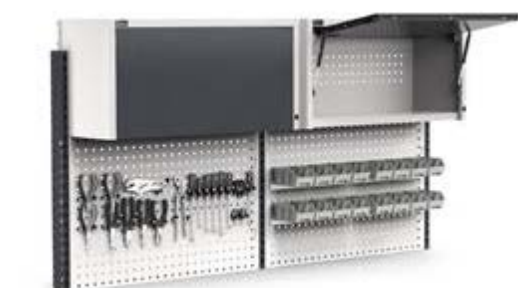

ART.	L mm	P mm	H mm	KG montanti	RAL	€
WORKLOOK2005	2000	373	1063	50	7035+7016	919,50
WORKLOOK2006	2000	373	1063	50	5012	919,50

Composto da:

qtà	descrizione
1	Kit 3 montanti biasolati
2	Kit 2 pannelli forati/mensole con 1 bordo fermacasse
2	Pensile vasistas senza serratura
2	Coppia staffe di fissaggio pensile su montanti
2	Gancio Unipok per utensili - confezione 30 pezzi
4	Barra aggancio per contenitori Picking Box mis. 1/2
4	Kit 4 contenitori Picking Box Air mis. 1



ART.	L mm	P mm	H mm	KG montanti	RAL	€
WORKLOOK3005	2970	373	1063	50	7035+7016	1020,60
WORKLOOK3006	2970	373	1063	50	5012	1020,60

Composto da:

qtà	descrizione
1	Kit 3 montanti biasolati
2	Kit 2 pannelli forati/mensole con 1 bordo fermacasse
2	Pensile vasistas senza serratura
2	Coppia staffe di fissaggio pensile su montanti
5	Gancio Unipok per utensili - confezione 30 pezzi
2	Barra aggancio per contenitori Picking Box mis. 1/2
2	Kit 4 contenitori Picking Box Air mis. 1



PORTATA



RAL 7035 + RAL 7016



RAL 5012



RAL 7035







WORK LOOK

COMPONENTI

TAPPARELLE



ARMADIO CON TAPPARELLA

ART.	L mm	P mm	H mm	RAL	€
 FBL8050C00008	943	220	912	7035	501,90
 FBL8050C00004	943	220	912	5012	501,90
 FBL8054C00008	1428	220	912	7035	685,50
 FBL8054C00004	1428	220	912	5012	685,50
 FBL8056C00008	1928	220	912	7035	749,70
 FBL8056C00004	1928	220	912	5012	749,70

COPPIA STAFFE DI FISSAGGIO ARMADIO CON TAPPARELLA SU MONTANTI



ART.	L mm	P mm	H mm	RAL	€
 FBL8060000008	33	21	904	7035	27,90
 FBL8060000004	33	21	904	5012	27,90

 Da utilizzare per il fissaggio dell'armadio con tapparella ai montanti biasolati



BARRA LED

Senza pulsante on/off

ART.	L mm	temperatura colore K	Watt	Hz	Lumen	€
 FBL99400213	873	4000	15	50/60	1500	47,40
 FBL99450213	1173	4000	20	50/60	2000	48,60



WORK LOOK

TAPPARELLE CON MONTANTI E PANNELLI PER BANCHI



ART.	L mm	P mm	H mm	KG montanti	RAL	€
WORKLOOK1009	1015	710	1243	50	7035+7016	1002,60
WORKLOOK1010	1015	710	1243	50	5012	991,50

Composto da:

qtà	descrizione
1	Kit 2 montanti biasolati
1	Kit 2 supporti inclinati con binario
1	Lampada L=988 mm
1	Pannello forato Electric
1	Coppia staffe di fissaggio armadio con tapparella su montanti
1	Armadio con tapparella
4	Gancio Unipok per utensili - confezione 30 pezzi



ART.	L mm	P mm	H mm	KG montanti	RAL	€
WORKLOOK1515	1500	710	1243	50	7035+7016	1232,10
WORKLOOK1516	1500	710	1243	50	5012	1216,50

Composto da:

qtà	descrizione
1	Kit 2 montanti biasolati
1	Kit 2 supporti inclinati con binario
1	Lampada L=988 mm
1	Pannello forato Electric
1	Coppia staffe di fissaggio armadio con tapparella su montanti
1	Armadio con tapparella
6	Gancio Unipok per utensili - confezione 30 pezzi



ART.	L mm	P mm	H mm	KG montanti	RAL	€
WORKLOOK2009	2000	710	1243	50	7035+7016	1766,10
WORKLOOK2010	2000	710	1243	50	5012	1747,20

Composto da:

qtà	descrizione
1	Kit 3 montanti biasolati
1	Kit 3 supporti inclinati con 2 binari
1	Lampada L=1473 mm
2	Pannello forato Electric
2	Coppia staffe di fissaggio armadio con tapparella su montanti
2	Armadio con tapparella
8	Gancio Unipok per utensili - confezione 30 pezzi



ART.	L mm	P mm	H mm	KG montanti	RAL	€
WORKLOOK2011	2000	300	1064	50	7035+7016	1042,50
WORKLOOK2012	2000	300	1064	50	5012	1035,90

Composto da:

qtà	descrizione
1	Kit 3 montanti biasolati
2	Pannello forato Electric
1	Coppia staffe di fissaggio armadio con tapparella su montanti
1	Armadio con tapparella
8	Gancio Unipok per utensili - confezione 30 pezzi



PORTATA



RAL 7035 + RAL 7016



RAL 5012



RAL 7035

WORK LOOK

PANNELLI FORATI A MURO



KIT STAFFE PER FISSAGGIO PANNELLI A PARETE

ART.	finitura	€
FVT02550000	Zincato	16,50

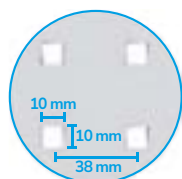
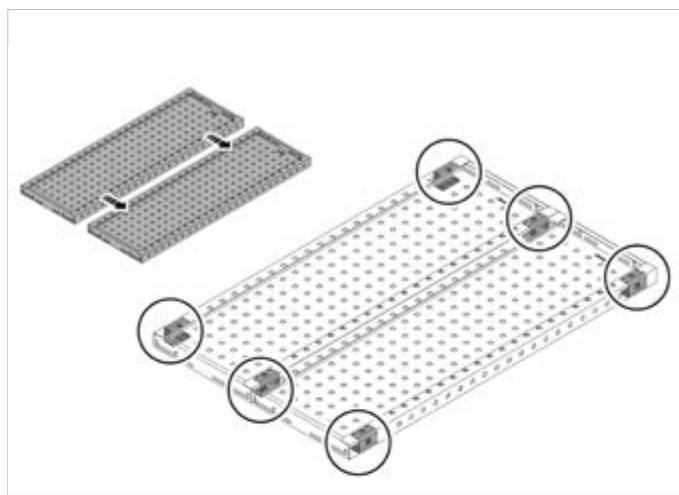

PANNELLO FORATO/MENSOLA

ART.	L mm	P mm	H mm	RAL	€
FBL76160008	953	40	304	7035	26,40
FBL76160004	953	40	304	5012	26,40
FBL76310008	1438	40	304	7035	31,20
FBL76310004	1438	40	304	5012	31,20

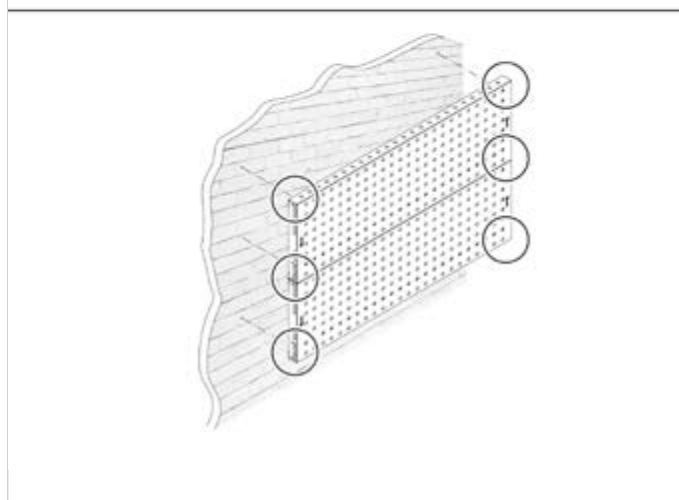

PARETE PORTA ATTREZZI

ART.	L mm	P mm	H mm	RAL	€
WORKLOOK1510	1438	151	608	7035	140,70
WORKLOOK1509	1438	151	608	5012	140,70

Composto da:

qtà	descrizione
2	Pannello forato/mensola
2	Kit staffe per fissaggio pannelli a parete
1	Porta bombolette inclinato a 2 posti
1	Gancio Unipok per utensili - confezione 30 pezzi
10	Gancio con puntale P=100 mm

WORK LOOK

PANNELLI FORATI A MURO

Pannelli forati vedi pag. 166 / 167
 Fissaggio a muro dei pannelli forati vedi pag. 162
 Ganci Unipok vedi pag. 191
 Ganci The Block vedi pag. 195
 Accessori Iron Team vedi pag. 196



PARETE PORTA ATTREZZI

ART.	Lmm	Pmm	Hmm	RAL	€
WORKLOOK1512	1438	218	608	7035	169,80
WORKLOOK1511	1438	218	608	5012	169,80

Composto da:

qtà	descrizione
2	Pannello forato/mensola
2	Kit staffe per fissaggio pannelli a parete
1	Kit porta rotolo con carta Ø=130 mm
1	Gancio Unipok per utensili - confezione 30 pezzi
10	Gancio con puntale P=100 mm
1	Barra aggancio per contenitori Picking Box mis. 1/2
1	Kit 4 contenitori Picking Box Air mis. 1



PARETE PORTA ATTREZZI

ART.	Lmm	Pmm	Hmm	RAL	€
WORKLOOK1514	1438	275	608	7035	157,20
WORKLOOK1513	1438	275	608	5012	157,20

Composto da:

qtà	descrizione
2	Pannello forato/mensola
2	Kit staffe per fissaggio pannelli a parete
1	Gancio Unipok per utensili - confezione 30 pezzi
10	Gancio con puntale P=100 mm
10	Gancio con puntale P=150 mm
1	Barra aggancio per contenitori Picking Box mis. 1/2
1	Kit 3 contenitori Picking Box Air mis. 2



RAL 5012

RAL 7035





ZINCATO

WORK LOOK

COMPONENTI MONTANTI







KIT 2 MONTANTI BIASOLATI

ART.	L mm	P mm	H mm	KG	adatto per banco L mm	RAL	€
 FBL75301604	30	80	639	50	1000-1500	5012	39,90
 FBL75301639	30	80	639	50	1000-1500	7016	39,90
 FBL75351604	30	80	943	50	1000-1500	5012	48,90
 FBL75351639	30	80	943	50	1000-1500	7016	48,90



KIT 3 MONTANTI BIASOLATI

ART.	L mm	P mm	H mm	KG	adatto per banco L mm	RAL	€
 FBL75302104	30	80	639	50	2000-3000	5012	60,60
 FBL75302139	30	80	639	50	2000-3000	7016	60,60
 FBL75352104	30	80	943	50	2000-3000	5012	71,70
 FBL75352139	30	80	943	50	2000-3000	7016	71,70

WORK LOOK

COMPONENTI

SUPPORTI INCLINATI CON BINARIO BASE



KIT 2 SUPPORTI INCLINATI CON BINARIO

ART.	L mm	P mm	H mm	RAL	€
FBL98102039	1015	686	307	7016	89,40
FBL98102004	1015	686	307	5012	81,60



KIT 2 SUPPORTI INCLINATI CON BINARIO

ART.	L mm	P mm	H mm	RAL	€
FBL98152039	1500	686	307	7016	92,40
FBL98152004	1500	686	307	5012	84,90



KIT 3 SUPPORTI INCLINATI CON 2 BINARI

ART.	L mm	P mm	H mm	RAL	€
FBL98202039	2000	686	307	7016	140,40
FBL98202004	2000	686	307	5012	128,10



KIT 3 SUPPORTI INCLINATI CON 2 BINARI

ART.	L mm	P mm	H mm	RAL	€
FBL98302039	2970	686	307	7016	146,40
FBL98302004	2970	686	307	5012	135,90



BINARIO SUPPLEMENTARE CON ATTACCHI

ART.	L mm	P mm	H mm	materiale	€
FBL98101000	1015	60	67	Alluminio	37,20
FBL98151000	1500	60	67	Alluminio	42,00



SET ARIA COMPRESSA CON BILANCIATORE E FILTRO

ART.	€
FBL97200300	469,20

Completo di:
 1 cavo flessibile Ø 10 mm
 1 connettore a T da 1/4" con tappo (B)
 2 attacchi di scorrimento
 1 moschettone
 1 bilanciatore con cavo in acciaio lunghezza 1600 mm portata 1/2 kg
 1 attacco universale 1/4" per utensili (A)
 1 tubo a spirale diametro interno 5,5 mm
 1 tubo diametro interno 5,5 mm per lo spurgo del filtro
 1 gruppo filtro regolatore con manometro - il quale può essere utilizzato con una pressione massima di 10 bar, la sua capacità è di circa 9 litri al secondo (sul punto A) e di 11 litri al secondo (sul punto B) con una pressione di utilizzo pari a 6,3 bar (la capacità può variare a seconda delle caratteristiche tecniche della rete pneumatica a cui l'impianto Fami viene allacciato)
 raccordi da 1/4"



PORTATA



RAL 5012



RAL 7016



ALLUMINIO

WORK LOOK

COMPONENTI

PANNELLI FORATI/MENSOLA 953 mm

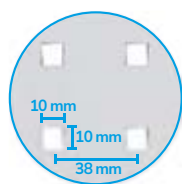

1. USB Dati
2. Magnetotermico differenziale
3. Multipresa 4 scomparti
4. Multipresa 2 scomparti
5. USB Ricarica

PANNELLO FORATO/MENSOLA

ART.	L mm	P mm	H mm	Dim. foro mm	Passo mm	RAL	€
FBL76160008	953	40	304	10x10	38	7035	26,40
FBL76160004	953	40	304	10x10	38	5012	26,40

KIT 2 PANNELLI FORATI/MENSOLE CON 1 BORDO FERMACASSE

ART.	L mm	P mm	H mm	Dim. foro mm	Passo mm	RAL	€
FBL76160208	953	40	304	10x10	38	7035	57,60
FBL76160204	953	40	304	10x10	38	5012	57,60

KIT 3 PANNELLI FORATI/MENSOLE CON 2 BORDI FERMACASSE

ART.	L mm	P mm	H mm	Dim. foro mm	Passo mm	RAL	€
FBL76160308	953	40	304	10x10	38	7035	88,20
FBL76160304	953	40	304	10x10	38	5012	88,20

PANNELLO FORATO/MENSOLA CON 1 BORDO FERMACASSE

ART.	L mm	P mm	H mm	Dim. foro mm	Passo mm	RAL	€
FBL76170108	953	40	456	10x10	38	7035	42,90
FBL76170104	953	40	456	10x10	38	5012	42,90

PANNELLO FORATO ELECTRIC

ART.	L mm	P mm	H mm	Dim. foro mm	Passo mm	RAL	€
FBL76180008	953	31	152	10x10	38	7035	42,60
FBL76180004	953	31	152	10x10	38	5012	39,30

WORK LOOK

COMPONENTI

PANNELLI FORATI/MENSOLA 1438 mm

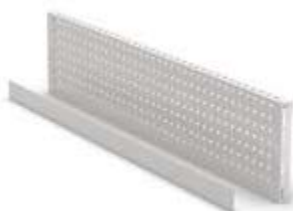
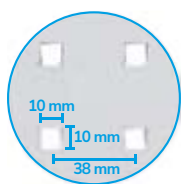

1. USB Dati
2. Magnetotermico differenziale
3. Multipresa 4 scomparti
4. Multipresa 2 scomparti
5. USB Ricarica

PANNELLO FORATO/MENSOLA

ART.	L mm	P mm	H mm	Dim. foro mm	Passo mm	RAL	€
FBL76310008	1438	40	304	10x10	38	7035	31,20
FBL76310004	1438	40	304	10x10	38	5012	31,20

KIT 2 PANNELLI FORATI/MENSOLE CON 1 BORDO FERMACASSE

ART.	L mm	P mm	H mm	Dim. foro mm	Passo mm	RAL	€
FBL76310208	1438	40	304	10x10	38	7035	69,30
FBL76310204	1438	40	304	10x10	38	5012	69,30

KIT 3 PANNELLI FORATI/MENSOLE CON 2 BORDI FERMACASSE

ART.	L mm	P mm	H mm	Dim. foro mm	Passo mm	RAL	€
FBL76310308	1438	40	304	10x10	38	7035	104,70
FBL76310304	1438	40	304	10x10	38	5012	104,70

PANNELLO FORATO/MENSOLA CON 1 BORDO FERMACASSE

ART.	L mm	P mm	H mm	Dim. foro mm	Passo mm	RAL	€
FBL76320108	1438	40	456	10x10	38	7035	51,00
FBL76320104	1438	40	456	10x10	38	5012	51,00

PANNELLO FORATO ELECTRIC

ART.	L mm	P mm	H mm	Dim. foro mm	Passo mm	RAL	€
FBL76330008	1438	31	152	10x10	38	7035	58,50
FBL76330004	1438	31	152	10x10	38	5012	50,40

RAL 5012

RAL 7035

WORK LOOK

COMPONENTI

PANNELLI FORATI/MENSOLA 1938 mm

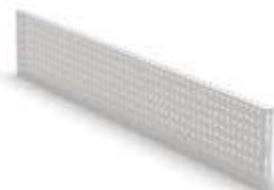
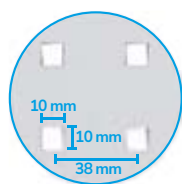

PANNELLO FORATO/MENSOLA

ART.	L mm	P mm	H mm	Dim. foro mm	Passo mm	RAL	€
FBL76360008	1938	40	304	10x10	38	7035	40,50
FBL76360004	1938	40	304	10x10	38	5012	40,50

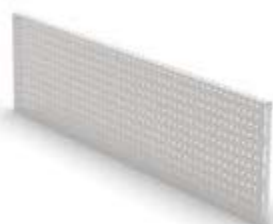

PANNELLO FORATO/MENSOLA

ART.	L mm	P mm	H mm	Dim. foro mm	Passo mm	RAL	€
FBL76370008	1938	40	456	10x10	38	7035	47,40
FBL76370004	1938	40	456	10x10	38	5012	47,40



COPPIA SUPPORTI PER PANNELLO FORATO/MENSOLA

ART.	L mm	P mm	H mm	RAL	€
FVT01010039	12	237	99	7016	14,40



WORK LOOK



ART.	RAL	€
 WORKLOOK9001	7035	1167,30



Composto da:

qtà	descrizione	qtà	descrizione
2	Pannello forato/mensola con 1 bordo fermacasse	1	Cestino capacità 30 L
3	Pannello forato/mensola	5	Gancio Unipok per utensili - confezione 30 pezzi
5	Kit staffe per fissaggio pannelli a parete	1	Multipresa schuko a 2 scomparti
1	Mensola porta oggetti reversibile	1	Multipresa schuko a 4 scomparti
1	Porta flacone igienizzante reversibile	1	Magnetotermico differenziale
1	Kit porta rotolo con carta Ø=240 mm	1	Cavo di collegamento wieland schuko/francese
1	Dispenser per guanti	1	Supporto multipresa a 2 scomparti
1	Tasca porta documenti A4	1	Supporto multipresa a 4 scomparti
2	Mensola grande reversibile	1	Supporto per magnetotermico differenziale
		2	Lampada doppia

RAL 5012

RAL 7016



RAL 7035

COMPONENTS

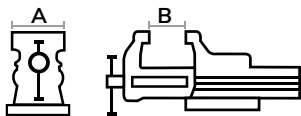

COMPONENTS

MORSE WORK TECH



Ganasce stringitubo di serie



KIT VITI PER FISSAGGIO MORSA AL PIANO

ART.	€
F22VT000050Z000	3,30



MORSA PROFESSIONALE MODELLO WORK TECH

ART.	L mm	P mm	H mm	A mm	B mm	RAL	€
F22FABL11500039	100	300	138	100	125	7016	127,20

⚠ Con ganasce stringitubo per tubi con Ø esterno 16-40 mm



MORSA PROFESSIONALE CON BASE GIREVOLE MODELLO WORK TECH

ART.	L mm	P mm	H mm	A mm	B mm	RAL	€
IRONTEAM003	100	300	138	100	125	7016	172,50

⚠ Con ganasce stringitubo per tubi con Ø esterno 16-40 mm



MORSA PROFESSIONALE MODELLO WORK TECH

ART.	L mm	P mm	H mm	A mm	B mm	RAL	€
F22FABL11550039	120	375	170	120	150	7016	170,70

⚠ Con ganasce stringitubo per tubi con Ø esterno 16-58 mm



MORSA PROFESSIONALE CON BASE GIREVOLE MODELLO WORK TECH

ART.	L mm	P mm	H mm	A mm	B mm	RAL	€
IRONTEAM004	120	375	170	120	150	7016	228,30

⚠ Con ganasce stringitubo per tubi con Ø esterno 16-58 mm

COMPONENTS

MORSE WORK GO

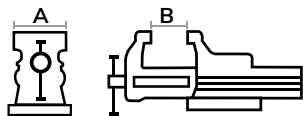

Ganasce stringitubo di serie



MORSA PROFESSIONALE MODELLO WORK GO

ART.	L mm	P mm	H mm	A mm	B mm	RAL	€
F22FABL11600039	120	333	122	100	125	7016	141,30

⚠ Con ganasce stringitubo per tubi con Ø esterno 17-42 mm



MORSA PROFESSIONALE CON BASE GIREVOLE MODELLO WORK GO

ART.	L mm	P mm	H mm	A mm	B mm	RAL	€
IRONTEAM005	120	333	122	100	125	7016	180,60

⚠ Con ganasce stringitubo per tubi con Ø esterno 17-42 mm



MORSA PROFESSIONALE MODELLO WORK GO

ART.	L mm	P mm	H mm	A mm	B mm	RAL	€
F22FABL11650039	150	389	150	120	150	7016	155,10

⚠ Con ganasce stringitubo per tubi con Ø esterno 17-48 mm



MORSA PROFESSIONALE CON BASE GIREVOLE MODELLO WORK GO

ART.	L mm	P mm	H mm	A mm	B mm	RAL	€
IRONTEAM006	150	389	150	120	150	7016	199,80

⚠ Con ganasce stringitubo per tubi con Ø esterno 17-48 mm

COMPONENTS

MORSE WORK STRONG

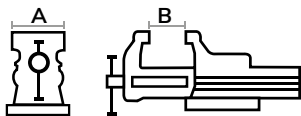

Ganasce stringitubo di serie



MORSA PROFESSIONALE MODELLO WORK STRONG

ART.	L mm	P mm	H mm	A mm	B mm	RAL	€
F22FABL11700039	160	425	167	135	170	7016	200,40

⚠ Con ganasce stringitubo per tubi con Ø esterno 17-48 mm



MORSA PROFESSIONALE CON BASE GIREVOLE MODELLO WORK STRONG

ART.	L mm	P mm	H mm	A mm	B mm	RAL	€
IRONTEAM007	160	425	167	135	170	7016	249,30

⚠ Con ganasce stringitubo per tubi con Ø esterno 17-48 mm



MORSA PROFESSIONALE MODELLO WORK STRONG

ART.	L mm	P mm	H mm	A mm	B mm	RAL	€
F22FABL11750039	180	480	187	150	190	7016	216,30

⚠ Con ganasce stringitubo per tubi con Ø esterno 17-76 mm



MORSA PROFESSIONALE CON BASE GIREVOLE MODELLO WORK STRONG

ART.	L mm	P mm	H mm	A mm	B mm	RAL	€
IRONTEAM008	180	480	187	150	190	7016	269,40

⚠ Con ganasce stringitubo per tubi con Ø esterno 17-76 mm

COMPONENTS

SEDIE DA LAVORO



SEDIA REGOLABILE CON POMPA A GAS CON RUOTE

ART.	L mm	P mm	materiale	H seduta mm	n. ruote	€
 FAX1100RG000000	630	630	Faggio	510/690	5	169,20



SEDIA REGOLABILE CON POMPA A GAS CON PIEDINI

ART.	L mm	P mm	materiale	H seduta mm	n. piedini	colore	€
 FAX120000000007	630	630	Poliuretano	580/840	5	Nero	254,70



SEDIA REGOLABILE CON POMPA A GAS CON RUOTE

ART.	L mm	P mm	materiale	H seduta mm	n. ruote	colore	€
 FAX125000000007	630	630	Poliuretano	540/730	5	Nero	210,30



SEDIA REGOLABILE CON POMPA A GAS CON RUOTE

ART.	L mm	P mm	materiale	H seduta mm	n. ruote	colore	€
 FAXCATY50000007	630	630	Poliuretano	435/565	5	Nero	362,40

COMPONENTS

SEDIE DA LAVORO



SEDIA REGOLABILE CON POMPA A GAS CON RUOTE

ART.	L mm	P mm	materiale	H seduta mm	n. ruote	colore	€
 FAXCATY8000007	630	630	Poliuretano	525/710	5	Nero	432,00





SEDIA ANTISTATICA REGOLABILE CON POMPA A GAS CON RUOTE

ART.	L mm	P mm	materiale	H seduta mm	n. ruote	colore	€
 FAXGREF21200001	640	640	Tessuto antistatico	470/600	5	Grigio scuro	411,90

TAVOLO PIEGHEVOLE





TAVOLO CON GAMBE PIEGHEVOLI

ART.	Dim. ingombro aperto			Dim. ingombro chiuso			materiale piano	 KG	RAL	€
	L mm	P mm	H mm	L mm	P mm	H mm				
 F22WWTABLE00039	1184	590	896	1100	590	60	Multiplex	400	7016	287,10



KIT 3 GANCI PER FISSAGGIO VERTICALE TAVOLO

ART.	L mm	P mm	H mm	 KG	RAL	€
 F22WWTABLEFIS39	152	81	92	25	7016	29,70

 PORTATA

 RAL 7016

ERGO WORK

BRACCI ESTENSIBILI SERIE PRO



I **bracci estensibili** Ergo Work aumentano lo spazio di stoccaggio a disposizione dell'operatore su banchi da lavoro e carrelli. È possibile scegliere tra due diverse tipologie di bracci: i primi possono essere installati direttamente sul **montante** della parete attrezzata, mentre i secondi sono fissati sul **piano di lavoro**. Grazie all'ampio angolo di rotazione, la posizione del braccio può essere facilmente regolata così da avere tutto a portata di mano e rendere la postazione sempre più ergonomica. Ergo Work può ospitare vassoi, piastre porta monitor, soluzioni con contenitori e pannelli forati.

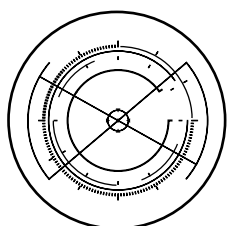

CONFIGURABILE

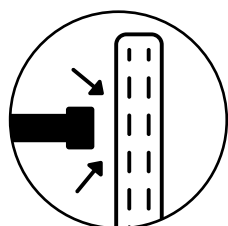

FISSAGGIO SU
MONTANTE

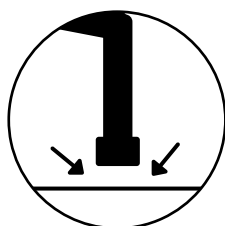

FISSAGGIO SU
PIANO



PORTATA 20 KG

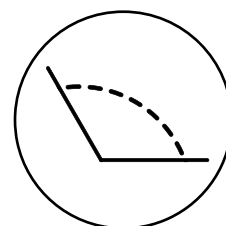

ANGOLO
ROTAZIONE 240-
260°

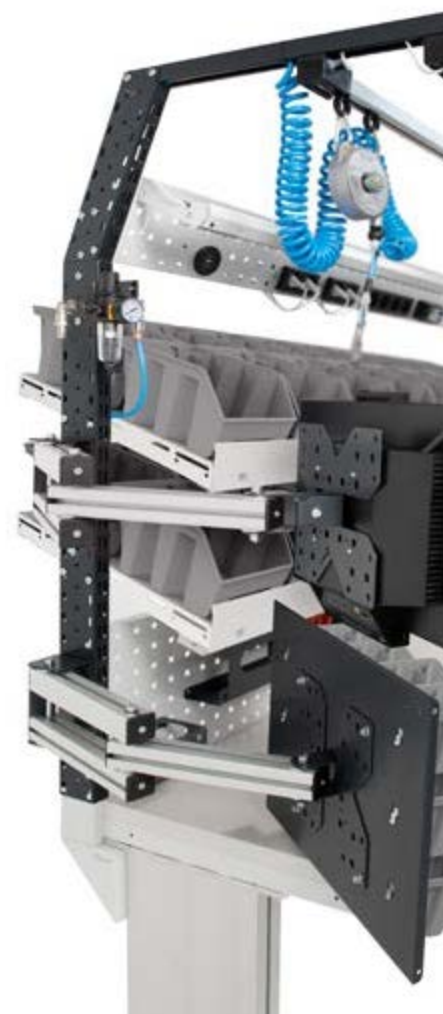

CONFIGURE

SHOP

PATENTED*

ART.	L mm	P mm	H mm	KG	RAL	€
DYNAMIC1506	1497/3139	780	1983/2383	400	7035+7016	4530,90

Composto da:

qtà	descrizione	qtà	descrizione
1	Banco smontato regolabile elettricamente	1	Multipresa schuko a 4 scomparti
1	Armadio L=500 mm con 1 cassetto H=150 mm	2	Multipresa schuko a 2 scomparti
1	Coperchio per armadio L=500 mm	1	Presse usb ricarica
1	Coppia supporti per armadio	1	Presse usb dati
1	Telaio portaprese aggiuntivo completo di tamponi e angolari	1	Cavo di collegamento wieland schuko/francese
1	Kit 2 montanti biasolati	1	Dispenser per guanti
1	Kit 2 supporti inclinati con binario	1	Porta flacone igienizzante reversibile
1	Lampada doppia	36	Contenitore in polipropilene Picking Box Air mis. 2
1	Binario supplementare con attacchi	4	Braccio estensibile per montante
1	Set aria compressa con bilanciatore e filtro	1	Snodo per piastra
2	Pannello forato/mensola con 1 bordo fermacasse	3	Piastra porta monitor con standard VESA
3	Lampada singola	1	Pannello per Picking Box
1	Pannello forato/mensola	3	Barra aggancio per contenitori Picking Box mis. 1/2
1	Pannello forato Electric	3	Kit 4 contenitori Picking Box Air mis. 1
2	Gancio Unipok per utensili - confezione 30 pezzi	1	Pannello per Visual Box
1	Magnetotermico differenziale	2	Cassetteria Visual Box con 6 cassette
1	Vassoio inclinato	1	Cassetteria Visual Box con 5 cassette



PORTATA



RAL 7035 + RAL 7016



BRACCIO ESTENSIBILE CON PICKING BOX

ART.	L mm	P mm	H mm	RAL	€
 ERGOWORK002	760/515	470/283	356	7016	185,10

Composto da:

qtà	descrizione
1	Braccio estensibile per montante
1	Piastra porta monitor con standard VESA
1	Pannello per Picking Box
3	Barra aggancio per contenitori Picking Box mis. 1/2
3	Kit 4 contenitori Picking Box Air mis. 1



BRACCIO ESTENSIBILE CON PICKING BOX

ART.	L mm	P mm	H mm	RAL	€
 ERGOWORK003	826/515	470/348	356	7016	177,60

Composto da:

qtà	descrizione
1	Braccio estensibile per montante
1	Piastra porta monitor con standard VESA
1	Pannello per Picking Box
2	Barra aggancio per contenitori Picking Box mis. 1/2
1	Kit 3 contenitori Picking Box Air mis. 2
1	Kit 4 contenitori Picking Box Air mis. 1



BRACCIO ESTENSIBILE CON VISUAL BOX

ART.	L mm	P mm	H mm	RAL	€
 ERGOWORK004	738/612	601/294	390	7016	222,90

Composto da:

qtà	descrizione
1	Braccio estensibile per montante
1	Piastra porta monitor con standard VESA
1	Pannello per Visual Box
1	Cassettiera Visual Box con 5 cassette
2	Cassettiera Visual Box con 6 cassette



PIASTRA PORTA MONITOR CON SQUADRETTE

ART.	L mm	P mm	H mm	RAL	€
 ERGOWORK014	225/129	119/225	225	7016	42,00

Composto da:

qtà	descrizione
1	Coppia squadrette a L
1	Snodo per piastra
1	Piastra porta monitor con standard VESA



PANNELLO FORATO CON CERNIERE

ART.	L mm	P mm	H mm	RAL	€
 ERGOWORK007	647	60	496	7035	68,70

Composto da:

qtà	descrizione
1	Pannello forato/mensola con 1 bordo fermacasse
1	Kit cerniere per pannello forato



BRACCIO ESTENSIBILE CON VASSOIO INCLINATO

ART.	L mm	P mm	H mm	RAL	€
 ERGOWORK005	674/522	425/470	194	7016	146,40

Composto da:

qtà	descrizione
1	Braccio estensibile per montante
1	Vassoio inclinato



BRACCIO ESTENSIBILE CON PIASTRA PORTA MONITOR

ART.	L mm	P mm	H mm	RAL	€
 ERGOWORK001	652/330	225/225	225	7016	129,30

Composto da:

qtà	descrizione
1	Braccio estensibile per montante
1	Snodo per piastra
1	Piastra porta monitor con standard VESA



 RAL 7016

 RAL 7035



[CONFIGURE](#)

[SHOP](#)

ART.	L mm	P mm	H mm	senza ruote	set ruote	RAL	€
CLEVER1031	1036	672	1428	300	300	7035	646,50

Composto da:

qtà	descrizione	qtà	descrizione
1	Carrello smontato senza ruote	1	Profilo con base per piano
1	Piano in legno con supporti	1	Coppia squadrette a L
2	Pannello laterale forato	1	Snodo per piastra
1	Pannello posteriore forato	1	Piastra porta monitor con standard VESA
1	Coppia porte a battente	1	Kit ruote in gomma antitraccia sintetica Ø 125 mm



BRACCIO ESTENSIBILE CON VASSOIO INCLINATO



ART.	L mm	P mm	H mm	RAL	€
ERGOWORK013	745/521	425/480	552	7016	189,60

Composto da:

qtà	descrizione
1	Profilo con base per piano
1	Braccio estensibile per profilo
1	Vassoio inclinato

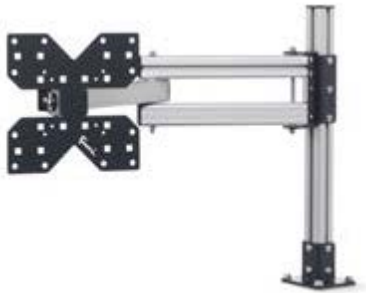

BRACCIO ESTENSIBILE CON PIASTRA PORTA MONITOR



ART.	L mm	P mm	H mm	RAL	€
ERGOWORK009	724/402	225/192	550	7016	172,50

Composto da:

qtà	descrizione
1	Profilo con base per piano
1	Braccio estensibile per profilo
1	Snodo per piastra
1	Piastra porta monitor con standard VESA



PROFILO CON PIASTRA PORTA MONITOR



ART.	L mm	P mm	H mm	RAL	€
ERGOWORK008	225/199	151/225	560	7016	82,20

Composto da:

qtà	descrizione
1	Profilo con base per piano
1	Coppia squadrette a L
1	Snodo per piastra
1	Piastra porta monitor con standard VESA



PORTATA



RAL 7016



RAL 7035



BRACCIO ESTENSIBILE CON PICKING BOX

ART.	L mm	P mm	H mm	RAL	€
 ERGOWORK010	832/515	470/300	628	7016	228,30

Composto da:

qtà	descrizione
1	Profilo con base per piano
1	Braccio estensibile per profilo
1	Piastra porta monitor con standard VESA
1	Pannello per Picking Box
3	Barra aggancio per contenitori Picking Box mis. 1/2
3	Kit 4 contenitori Picking Box Air mis. 1



BRACCIO ESTENSIBILE CON PICKING BOX

ART.	L mm	P mm	H mm	RAL	€
 ERGOWORK011	898/515	470/365	628	7016	220,80

Composto da:

qtà	descrizione
1	Profilo con base per piano
1	Braccio estensibile per profilo
1	Piastra porta monitor con standard VESA
1	Pannello per Picking Box
2	Barra aggancio per contenitori Picking Box mis. 1/2
1	Kit 3 contenitori Picking Box Air mis. 2
1	Kit 4 contenitori Picking Box Air mis. 1



BRACCIO ESTENSIBILE CON VISUAL BOX

ART.	L mm	P mm	H mm	RAL	€
 ERGOWORK012	808/601	601/275	668	7016	266,10

Composto da:

qtà	descrizione
1	Profilo con base per piano
1	Braccio estensibile per profilo
1	Piastra porta monitor con standard VESA
1	Pannello per Visual Box
1	Cassetteria Visual Box con 5 cassette
2	Cassetteria Visual Box con 6 cassette



ART.	L mm	P mm	H mm	KG	RAL	€
MASTERBR2008	3347	750	1985/2360	1000	7035+7016	2791,80

Composto da:

qtà	descrizione
1	Banco smontato con piano in multiplex 40 mm
1	Copertura per piano in multiplex
1	Armadio L=560 mm con 4 cassetti 1x75 2x150 1x200
1	Armadio L=560 mm predisposto per porta con 1 piano regolabile
1	Porta totale sinistra H=600 mm con maniglia Dark Grey
2	Semipiano aggiuntivo L=560 mm
1	Kit 2 montanti biasolati
1	Kit 2 supporti inclinati con binario
1	Binario supplementare con attacchi
1	Lampada doppia
1	Kit 3 pannelli forati/mensole con 2 bordi fermacasse
1	Pannello forato Electric
2	Multipresa schuko a 2 scomparti
1	Multipresa schuko a 4 scomparti
1	Piastra porta monitor con standard VESA

qtà	descrizione
1	Magnetotermico differenziale
1	Cavo di collegamento wieland schuko/francese
1	Porta flacone igienizzante reversibile
1	Dispenser per guanti
1	Kit porta rotolo con carta Ø=240 mm
4	Kit 2 contenitori Picking Box Air mis. 3A2
2	Pannello forato/mensola con 1 bordo fermacasse
2	Kit cerniere per pannello forato
8	Barra aggancio per contenitori Picking Box mis. 1/2
4	Kit 4 contenitori Picking Box Air mis. 1
4	Kit 3 contenitori Picking Box Air mis. 2
2	Profilo con base per piano
2	Braccio estensibile per profilo
1	Vassoio inclinato
1	Snodo per piastra



PORTATA



RAL 7035 + RAL 7016



RAL 7016

COMPONENTI

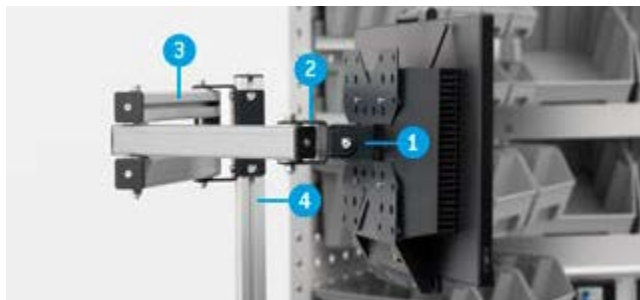

1. Piastra porta monitor con standard VESA
2. Snodo per piastra
3. Braccio estensibile per profilo
4. Profilo con base per piano

1. Piastra porta monitor con standard VESA
2. Pannello per Visual Box
3. Cassettiera Visual Box con 6 cassetti
4. Braccio estensibile per montante



BRACCIO ESTENSIBILE PER MONTANTE

ART.	L mm	P mm	H mm	angolo rotazione °	materiale	KG	RAL	€
 FBL74100039	580/330	72/97	158	240	Alluminio	20	7016	101,10



BRACCIO ESTENSIBILE PER PROFILO

Da utilizzare su profilo con base per piano

ART.	L mm	P mm	H mm	angolo rotazione °	materiale	KG	RAL	€
 FBL74180039	621/371	57/90	158	260	Alluminio	20	7016	104,10



PROFILO CON BASE PER PIANO

ART.	L mm	P mm	H mm	adatto per	materiale	KG	RAL	€
 FBL74160039	100	100	504	Piano in multiplex-Piano in MDF con copertura gommata	Alluminio	20	7016	40,20



PANNELLO PER VISUAL BOX

Da utilizzare con piastra porta monitor

ART.	L mm	P mm	H mm	Dim. foro mm	Passo mm	KG	RAL	€
 FBL74150039	601	31	313	10x10	38	20	7016	55,50

vedi Visual Box pag. 405

COMPONENTI



PIASTRA PORTA MONITOR CON STANDARD VESA

Orientabile su un asse



ART.	L mm	P mm	H mm	RAL	€
FBL74120039	225	50	225	7016	13,50



SNODO PER PIASTRA

Da utilizzare con piastra porta monitor per orientarla su due assi



ART.	L mm	P mm	H mm	RAL	€
FBL74110039	91	67	51	7016	14,70



COPPIA SQUADRETTE A L

Da utilizzare con piastra porta monitor



ART.	L mm	P mm	H mm	RAL	€
FBL74170039	38	36	32	7016	13,80



VASSOIO INCLINATO



ART.	L mm	P mm	H mm	RAL	€
FBL74130039	425	308	135	7016	45,30



1. Vassoio inclinato
2. Braccio estensibile per profilo
3. Profilo con base per piano



PORTATA



RAL 7016



ALLUMINIO

COMPONENTI



PANNELLO PER PICKING BOX

Da utilizzare con piastra porta monitor

ART.	L mm	P mm	H mm	adatto per	KG	RAL	€
FBL74140039	470	12	356	Contenitore Picking Box mis. 1/2	20	7016	40,80



BARRA AGGANCIAMENTO PER CONTENITORI PICKING BOX MIS. 1/2

ART.	L mm	P mm	H mm	finitura	€
FBLIT020099	445	14	89	Zincato	4,20

KIT 4 CONTENITORI PICKING BOX AIR MIS. 1

ART.	dim. ingombro			colore	€
	L mm	P mm	H mm		
FBLIT0600LQ	108	173	76		5,70
FBLIT060039	108	173	76		5,70
FBLIT060032	108	173	76		5,70
FBLIT06001Z	108	173	76		5,70
FBLIT06002Y	108	173	76		5,70
FBLIT06004Q	108	173	76		5,70



KIT 3 CONTENITORI PICKING BOX AIR MIS. 2

ART.	dim. ingombro			colore	€
	L mm	P mm	H mm		
FBLIT0610LQ	160	234	127		8,10
FBLIT061039	160	234	127		8,10
FBLIT061032	160	234	127		8,10
FBLIT06101Z	160	234	127		8,10
FBLIT06102Y	160	234	127		8,10
FBLIT06104Q	160	234	127		8,10

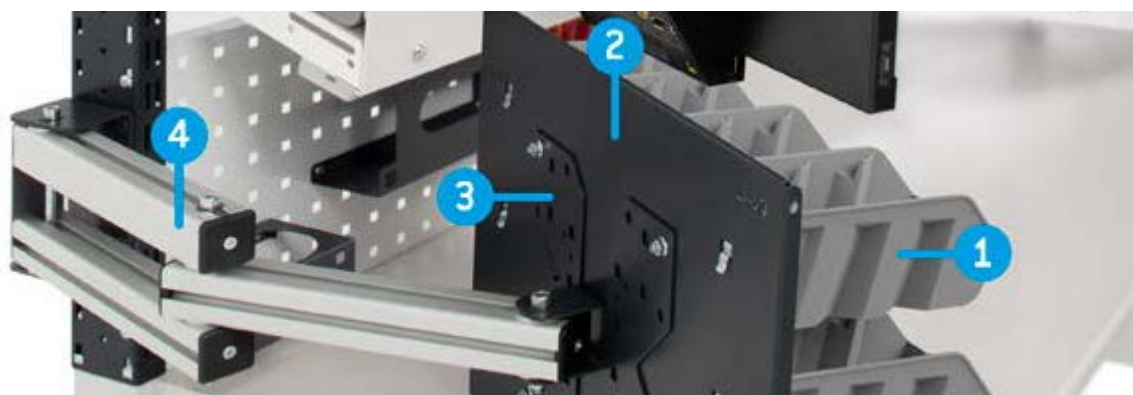

1. Barra aggancio per contenitori Picking Box mis. 1/2
Kit 4 contenitori Picking Box Air mis. 1
2. Pannello per Picking Box
3. Piastra porta monitor con standard VESA
4. Braccio estensibile per montante



CONFIGURE

SHOP

PATENTED

ART.	L mm	P mm	H mm	KG	RAL	€
MASTERBR1509	1706/3016	750	1985/2360	1000	7035+7016	2695,50

Composto da:

qtà	descrizione	qtà	descrizione
1	Banco smontato con piano in multiplex 40 mm	3	Braccio estensibile per montante
1	Armadio L=560 mm con 5 cassetti 1x75 3x100 1x200	1	Snodo per piastra
2	Piano superiore/inferiore L=560 mm	2	Piastra porta monitor con standard VESA
1	Porta totale sinistra H=600 mm con maniglia Dark Grey	1	Vassoio inclinato
1	Piano interno L=558 mm	1	Pannello per Visual Box
1	Supporto semipiano intermedio	1	Cassettiera Visual Box con 5 cassetti
2	Pannello forato laterale	2	Cassettiera Visual Box con 6 cassetti
1	Kit 2 montanti biasolati	1	Cestino capacità 30 L
1	Kit 2 pannelli forati/mensole con 1 bordo fermacasse	2	Porta bombolette inclinato a 2 posti
1	Kit 2 supporti inclinati con binario	1	Tasca porta documenti A4
1	Lampada doppia	1	Kit porta rotolo con carta Ø=130 mm
1	Pensile vasistas senza serratura	3	Gancio Unipok per utensili - confezione 30 pezzi
1	Barra led	2	Barra aggancio per contenitori Picking Box mis. 1/2
1	Coppia staffe di fissaggio pensile su montanti	1	Kit 4 contenitori Picking Box Air mis. 1
1	Kit 3 contenitori Picking Box Air mis. 2		

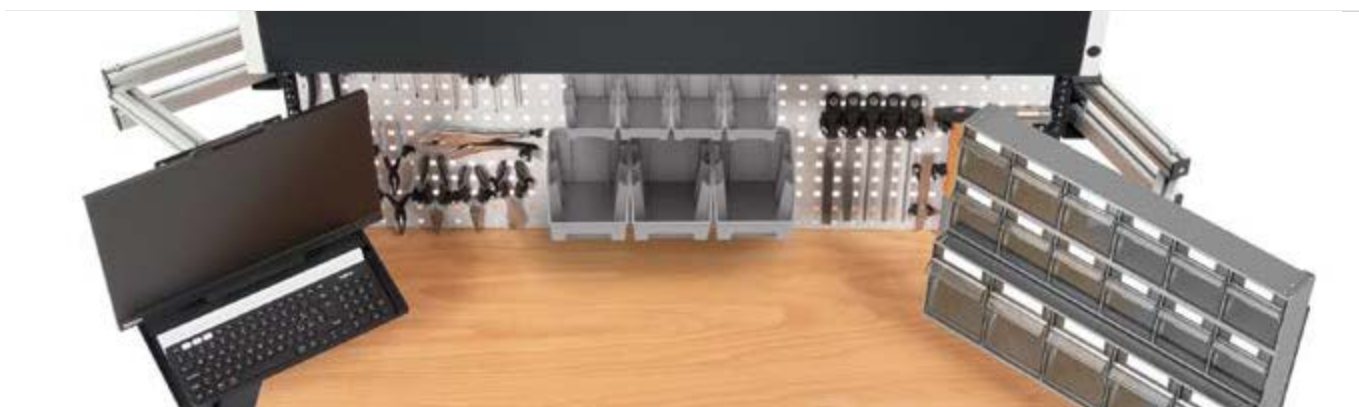

PORTATA



RAL 7035 + RAL 7016



RAL 7016





ZINCATO

COMPONENTI





PANNELLO FORATO/MENSOLA

ART.	L mm	P mm	H mm	Dim. foro mm	Passo mm	RAL	€
 FBL76070008	647	40	304	10x10	38	7035	23,40
 FBL76070004	647	40	304	10x10	38	5012	23,40



PANNELLO FORATO/MENSOLA CON 1 BORDO FERMACASSE

ART.	L mm	P mm	H mm	Dim. foro mm	Passo mm	RAL	€
 FBL76080108	647	40	456	10x10	38	7035	37,20
 FBL76080104	647	40	456	10x10	38	5012	37,20



KIT CERNIERE PER PANNELLO FORATO

ART.	L mm	P mm	H mm	 KG	€
 FBL7600011F	76	38	64	60	31,50

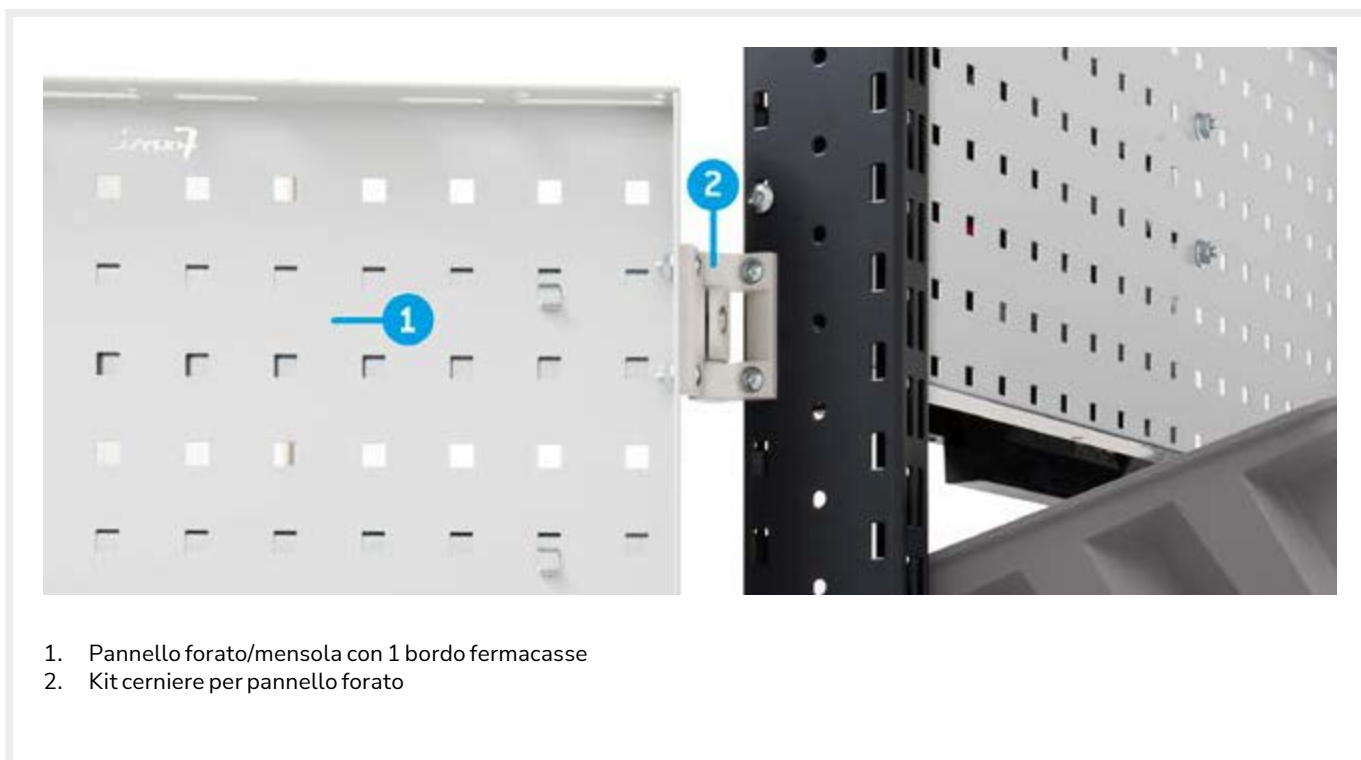

1. Pannello forato/mensola con 1 bordo fermacasse
2. Kit cerniere per pannello forato



[CONFIGURE](#)

[SHOP](#)

PATENTED*

ART.	L mm	P mm	H mm	KG	RAL	€
DYNAMIC1505	1497/1672	780	1983/2383	400	7035+7016	2817,30

Composto da:

qtà	descrizione
1	Banco smontato regolabile elettricamente
1	Armadio L=500 mm con 1 cassetto H=150 mm
1	Coperchio per armadio L=500 mm
1	Coppia supporti per armadio
1	Telaio portaprese aggiuntivo completo di tamponi e angolari
1	Kit 2 montanti biasolati
1	Coppia supporti per parete attrezzata L=1000 mm
1	Kit 2 supporti inclinati con binario
1	Lampada doppia
1	Kit 3 pannelli forati/mensole con 2 bordi fermacasse
1	Pannello forato Electric
4	Kit 2 contenitori Picking Box Air mis. 3A2
2	Porta bombolette inclinato a 2 posti

qtà	descrizione
1	Magnetotermico differenziale
1	Multipresa schuko a 4 scomparti
2	Multipresa schuko a 2 scomparti
1	Cavo di collegamento wieland schuko/francese
1	Coppia squadrette a L
1	Snodo per piastra
1	Piastra porta monitor con standard VESA
2	Pannello forato/mensola con 1 bordo fermacasse
2	Kit cerniere per pannello forato
6	Barra aggancio per contenitori Picking Box mis. 1/2
2	Kit 4 contenitori Picking Box Air mis. 1
4	Kit 3 contenitori Picking Box Air mis. 2



PORTATA



RAL 7035 + RAL 7016



RAL 5012



RAL 7035

**UNIPOK
THE BLOCK**

**PIKPAD
IRON TEAM**

**TOOL ORGANIZER
SERIE PRO**

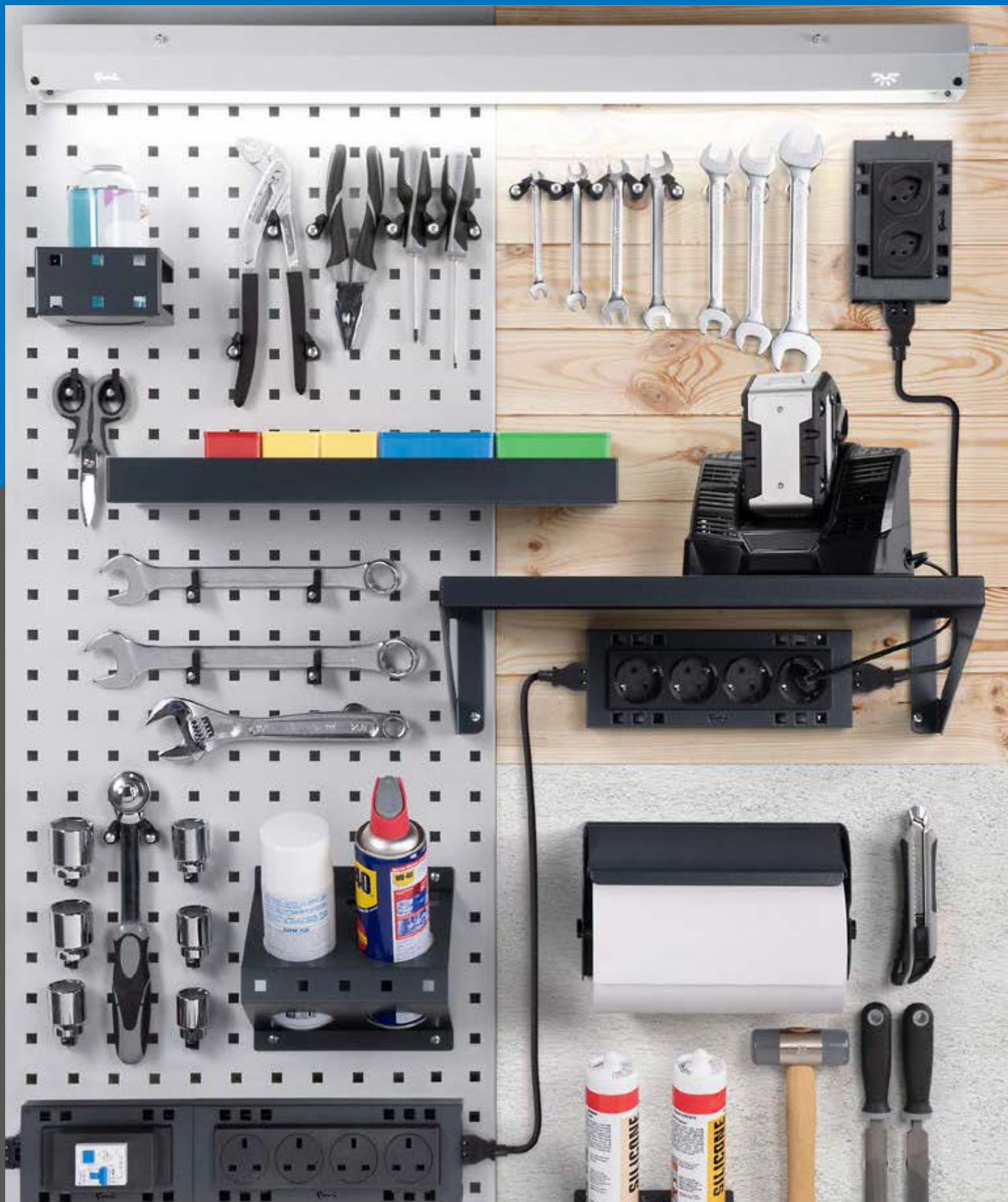



GANCIO UNIPOK PER UTENSILI - CONFEZIONE 30 PEZZI

Con una confezione si possono agganciare fino a 30 utensili

ART.	pz. per confezione	colore	€
FBLIT009007	30	Nero	13,50



x30 x30 x30 x15

Unipok sono i **ganci universali** di Fami che, grazie al sistema a vite, possono essere posizionati su pareti forate o pannelli in legno. Ogni Unipok può essere posizionato con diverse inclinazioni per poter fissare utensili di volumi e dimensioni differenti. Libera la tua fantasia per organizzare al meglio la tua parete forata da muro o da banco e la tua parete in legno per avere sempre tutto a portata di mano!



Fissaggio su legno



Fissaggio su pannello forato

Con Unipok l'ordine è un gioco da ragazzi!

IN 4 POSIZIONI TUTTE LE COMBINAZIONI CHE VUOI!





CREARE IL PERFETTO 5S SHADOW TOOL BOX CON PIKPAD!

Con **Pikpad** è possibile allestire un **5S shadow tool box** organizzato nel minimo dettaglio. Il fondo a foro quadro 10x10 del vassoio consente l'installazione di **Unipok** per creare **kit su misura** per ogni lavoro da svolgere e, grazie alle pratiche **etichette utensili**, sarà possibile identificare la tipologia di attrezzo che deve alloggiare in ogni spazio realizzato.

Pikpad è fornito completo di un set di 5 fogli adesivi:

- 4 fogli con più di 250 etichette di utensili (forma utensile + misura)
- 1 foglio non pretagliato per realizzare adesivi personalizzati

Unipok deve essere acquistato separatamente



VASSOIO PIKPAD 5S SHADOW TOOL BOX

ART.	LEH	PEH	L mm	P mm	H mm	RAL	€
FBLIT033039	18	18	284	287	50	7016	43,20

[CONFIGURE](#)

[SHOP](#)

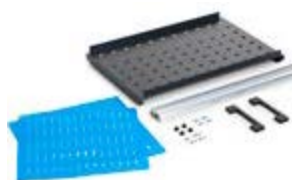

VASSOIO PIKPAD 5S SHADOW TOOL BOX

ART.	LEH	PEH	L mm	P mm	H mm	RAL	€
FBLIT034039	27	18	437	287	50	7016	52,50

[CONFIGURE](#)

[SHOP](#)



VASSOIO PIKPAD 5S SHADOW TOOL BOX

ART.	LEH	PEH	L mm	P mm	H mm	RAL	€
FBLIT035039	36	18	590	287	50	7016	61,80

[CONFIGURE](#)

[SHOP](#)



3 POSIZIONI DI REGOLAZIONE

Il **profilo brevettato** integrato nella parte posteriore di Pikpad consente di **regolare** il vassoio in **3 diverse posizioni**. È possibile, così, adattare l'inclinazione di Pikpad in base all'altezza e alla postura dell'utilizzatore per poter avere tutto a portata di mano e lavorare seguendo i principi dell'**ergonomia**.



SOSTEGNO DA TAVOLO PER VASSOIO PIKPAD 5S SHADOW TOOL BOX

ART.	L mm	P mm	H mm	RAL	€
PIKPAD001	653	255	198	7016	40,80
PIKPAD002	959	255	198	7016	44,70
PIKPAD003	1444	255	198	7016	56,70

ORGANIZZAZIONE MOBILE

I 5S shadow tool box rendono mobile l'organizzazione dell'attrezzatura in quanto possono essere installati su diversi supporti e facilmente movimentati tramite maniglie laterali. Sono posizionabili su piani di lavoro tramite l'apposito sostegno da tavolo, sui montanti delle pareti attrezzate allestite con barre in alluminio all'interno di cassetti. In quest'ultimo caso, è possibile aumentare esponenzialmente l'organizzazione interna delle cassettiere integrando Pikpad con i tradizionali materiali di separazione come cassette divisorio e divisori in metallo.





BRACCIO ESTENSIBILE PER MONTANTE CON SNODO PER VASSOIO PIKPAD 5S



ART.	L mm	P mm	H mm	RAL	€
ERGOWORK015	636/220	663/663	160	7016	132,60

PROFILO IN ALLUMINIO PER VASSOIO PIKPAD 5S SHADOW TOOL BOX



ART.	L mm	P mm	H mm	€
FBLIT036000	647	35	60	14,10
FBLIT037000	953	35	60	18,00
FBLIT038000	1438	35	60	30,00
FBLIT039000	1938	35	60	42,30

COPPIA STAFFE PER FISSAGGIO PROFILO SU MONTANTE



ART.	RAL	€
FBLIT040039	7016	16,20

COPPIA STAFFE PER SOSTEGNO DA TAVOLO



ART.	RAL	€
FBLIT041039	7016	26,70



GANCIO CON PUNTALE

ART.	L mm	P mm	H mm	multiplo d'ordine	€
FBLIT030000	36	78	42	10	1,80
FBLIT031000	36	128	42	10	1,80
FBLIT032000	36	178	42	10	1,80

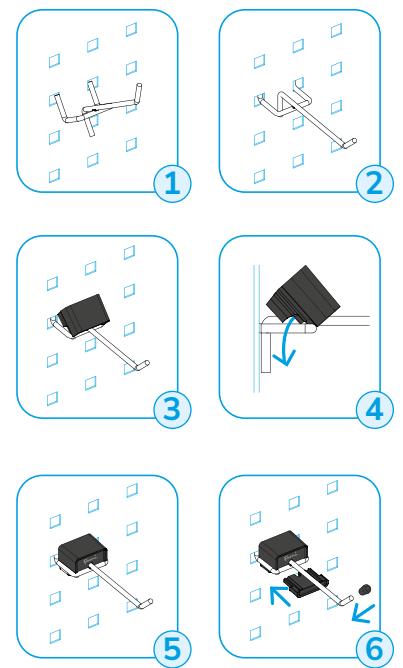
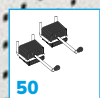
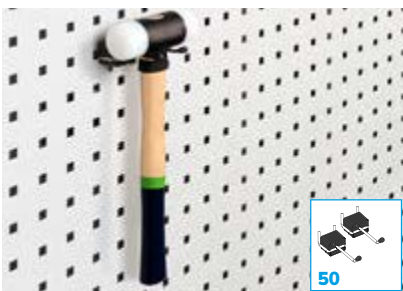
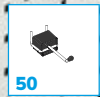
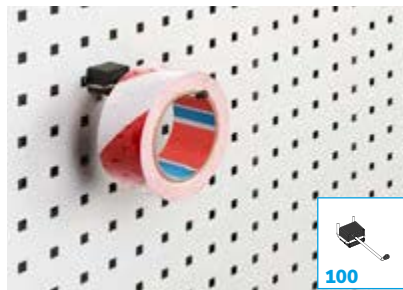
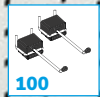

Il blocco di sicurezza ferma il gancio in posizione orizzontale e ne evita il movimento durante le operazioni di recupero/deposito utensili.





FISSAGGIO SU LEGNO



FISSAGGIO SU PANNELLO FORATO



FISSAGGIO SU MURO

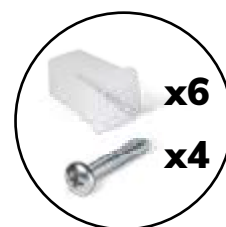

SET DI FISSAGGIO SU LEGNO E PANNELLO FORATO INCLUSO



MENSOLA PICCOLA REVERSIBILE

ART.	Lmm	Pmm	Hmm	RAL	€
 FBLIT017039	303	317	144	7016	22,50



MENSOLA GRANDE REVERSIBILE

ART.	Lmm	Pmm	Hmm	RAL	€
 FBLIT016039	455	317	144	7016	24,90





KIT 4 CONTENITORI PICKING BOX AIR MIS. 1

ART.	dim. ingombro			colore	€
	L mm	P mm	H mm		
FBLIT0600LQ	108	173	76		5,70
FBLIT060039	108	173	76		5,70
FBLIT060032	108	173	76		5,70
FBLIT06001Z	108	173	76		5,70
FBLIT06002Y	108	173	76		5,70
FBLIT06004Q	108	173	76		5,70



KIT 3 CONTENITORI PICKING BOX AIR MIS. 2

ART.	dim. ingombro			colore	€
	L mm	P mm	H mm		
FBLIT0610LQ	160	234	127		8,10
FBLIT061039	160	234	127		8,10
FBLIT061032	160	234	127		8,10
FBLIT06101Z	160	234	127		8,10
FBLIT06102Y	160	234	127		8,10
FBLIT06104Q	160	234	127		8,10



KIT 2 CONTENITORI PICKING BOX AIR MIS. 3A2

ART.	dim. ingombro			colore	€
	L mm	P mm	H mm		
FBLIT0270LQ	224	354	147		11,10
FBLIT027039	224	354	147		11,10
FBLIT027032	224	354	147		11,10
FBLIT02701Z	224	354	147		11,10
FBLIT02702Y	224	354	147		11,10
FBLIT02704Q	224	354	147		11,10



BARRA AGGANCIO PER CONTENITORI PICKING BOX MIS. 1/2

ART.	L mm	P mm	H mm	finitura	€
FBLIT020099	445	14	89	Zincato	4,20



Esempio di applicazione del kit 4 contenitori mis. 1 su barra aggancio



Esempio di applicazione del kit 3 contenitori mis. 2 su barra aggancio



RAL 7016

ZINCATO



PORTA SILICONE INCLINATO A 2 POSTI

ART.	Lmm	Pmm	Hmm	Ø foro mm	RAL	€
FBLIT008039	150	71	96	61	7016	13,80



PORTA BOMBOLETTE INCLINATO A 2 POSTI

ART.	Lmm	Pmm	Hmm	Ø foro mm	RAL	€
FBLIT007039	188	111	172	70	7016	13,80



PORTA BOMBOLETTE A 6 POSTI

ART.	Lmm	Pmm	Hmm	RAL	€
FBLIT010039	455	75	167	7016	26,40



KIT PORTA CONTENITORE CON CONTENITORE SALVIETTE LAVAMANI

ART.	RAL	€
FBLIT006039	7016	87,90



KIT PORTA ROTOLO CON CARTA Ø=240 MM

ART.	Lmm	Pmm	Hmm	RAL	€
FBLIT004039	297	275	270	7016	51,30



KIT PORTA ROTOLO CON CARTA Ø=130 MM

ART.	Lmm	Pmm	Hmm	RAL	€
FBLIT003039	257	135	168	7016	33,00



PORTA FLACONE IGIENIZZANTE REVERSIBILE

ART.	Lmm	Pmm	Hmm	RAL	€
FBLIT002039	113	100	62	7016	15,60



DISPENSER PER GUANTI

ART.	Lmm	Pmm	Hmm	RAL	€
FBLIT005039	247	81	132	7016	13,50



TASCA PORTA DOCUMENTI A4

ART.	L mm	P mm	H mm	RAL	€
FBLIT001039	365	68	187	7016	19,20



KIT PRONTO SOCCORSO

ART.	L mm	P mm	H mm	€
FBLIT024000	256	90	190	29,70



PORTA ESTINTORE CON ESTINTORE DA 2 KG

ART.	L mm	P mm	H mm	€
FBLIT023000	115	115	400	66,00



SELLA REGGICAVI

ART.	L mm	P mm	H mm	RAL	€
FBLIT019039	220	95	101	7016	21,60



KIT PORTA CONTENITORE

ART.	L cinghia mm	RAL	€
FBLIT018039	910	7016	33,60



MENSOLA PORTA TRAPANO AVVITATORE

ART.	L mm	P mm	H mm	RAL	€
FBLIT049039	152	228	125	7016	28,80



Mensola porta trapano avvitatore realizzata in collaborazione con:





MENSOLA PORTA OGGETTI REVERSIBILE

ART.	Lmm	Pmm	Hmm	RAL	€
 FBLIT015039	455	160	40	7016	26,10



PORTA PUNTE

ART.	Lmm	Pmm	Hmm	finitura	€
 FBLIT0260ZZ	155	84	39	Inox	28,50



KIT 10 CONTENITORI

ART.	€
 FBLIT028000	11,70



CALAMITA COMPLETA DI CLIP E VITE - CONFEZIONE 10 PEZZI

ART.	pz. per confezione	Ø mm	finitura	€
 FBL95410000	10	20	Zincato	50,70



VALIGETTA CON CONTENITORI

ART.	Lmm	Pmm	Hmm	€
 FBLIT022001	440	350	80	51,30

KIT PORTA VALIGETTA

ART.	RAL	€
 FBLIT021039	7016	44,70





PIASTRA PORTA MONITOR CON SQUADRETTE

ART.	Lmm	Pmm	Hmm	RAL	€
 ERGOWORK014	225/129	119/225	225	7016	42,00





CESTINO CAPACITÀ 30 L

ART.	Lmm	Pmm	Hmm	 CAPACITÀ	RAL	€
 FBLIT025039	387	277	394	30	7016	92,40



PENSILE CON PORTA

ART.	Lmm	Pmm	Hmm	 CAPACITÀ	RAL	€
 FBL8015C000PD	460	250	456	25	7035+7016	105,00
 FBL8015C00004	460	250	456	25	5012	102,00



CAPACITÀ



RAL 7035+RAL 7016



RAL 5012



RAL 7016



ZINCATO



INOX



SUPPORTO PER MAGNETOTERMICO DIFFERENZIALE

ART.	L mm	P mm	H mm	RAL	€
FBLET003039	159	32	92	7016	13,80



MAGNETOTERMICO DIFFERENZIALE 2P+T 16A, 30mA TYPE A

ART.	L mm	P mm	H mm	colore	€
FBLET012007	159	59	90	Nero	149,70



SUPPORTO MULTIPRESA A 2 SCOMPARTI

ART.	L mm	P mm	H mm	RAL	€
FBLET001039	148	32	92	7016	13,80



SUPPORTO MULTIPRESA A 4 SCOMPARTI

ART.	L mm	P mm	H mm	RAL	€
FBLET002039	249	32	92	7016	15,60



MULTIPRESA A 2 SCOMPARTI

ART.	L mm	P mm	H mm	tipo presa	colore	€
FBLET004007	148	59	46	Schuko	Nero	20,10
FBLET006007	148	59	46	Svizzera	Nero	43,20
FBLET008007	148	59	46	Inglese	Nero	35,10
FBLET010007	148	59	46	Francese	Nero	20,10



MULTIPRESA A 4 SCOMPARTI

ART.	L mm	P mm	H mm	tipo presa	colore	€
FBLET005007	248	59	46	Schuko	Nero	26,40
FBLET007007	248	59	46	Svizzera	Nero	49,50
FBLET009007	248	59	46	Inglese	Nero	61,20
FBLET011007	248	59	46	Francese	Nero	26,40



CAVO DI COLLEGAMENTO WIELAND CON SPINE IN/OUT

ART.	L mm	P mm	H mm	colore	€
 FBLET013007	200	28	13	Nero	18,60





CONNETTORE AD H WIELAND A 2 OUTPUT

ART.	L mm	P mm	H mm	colore	€
 FBLET015007	60	35	35	Nero	18,60



CAVO DI COLLEGAMENTO WIELAND

ART.	L mm	P mm	H mm	tipo spina	colore	€
 FBLET016007	3000	50	50	Schuko/Francese	Nero	18,60
 FBLET017007	3000	50	50	Inglese	Nero	22,50
 FBLET018007	3000	50	50	Svizzera	Nero	20,70



CAVO DI COLLEGAMENTO WIELAND CON SPINE IN/OUT

ART.	L mm	P mm	H mm	colore	€
 FBLET014007	1500	28	13	Nero	20,70





PRESA USB DATI

ART.	Ø mm	L mm	H mm	colore	€
 FBLET019007	59	70	54	Nero	149,10



PRESA USB RICARICA

ART.	Ø mm	L mm	H mm	colore	€
 FBLET020007	59	70	54	Nero	122,70



LAMPADA L=988 MM CON STAFFE DI FISSAGGIO

ART.	L mm	temperatura colore K	Watt	Hz	Lumen	RAL	€
 IRONTEAM001	988	4000	27	50	5058	7016	261,30



LAMPADA L=1473 MM CON STAFFE DI FISSAGGIO

ART.	L mm	temperatura colore K	Watt	Hz	Lumen	RAL	€
 IRONTEAM002	1473	4000	41	50	7588	7016	324,60

LIGHT



LAMPADA SINGOLA



Senza pulsante on/off

ART.	L mm	temperatura colore K	Watt	Hz	Lumen	RAL	€
 FBL99400008	922	4000	15	50/60	1500	7035	120,30
 FBL99450008	1407	4000	20	50/60	2000	7035	131,70



LAMPADA DOPPIA

Senza pulsante on/off

ART.	L mm	temperatura colore K	Watt	Hz	Lumen	RAL	€
 FBL99400108	922	4000	15	50/60	3000	7035	155,10
 FBL99450108	1407	4000	20	50/60	4000	7035	168,90



Esempio di fissaggio al binario aereo



Esempio di fissaggio al pannello forato tramite staffe



Esempio di fissaggio con calamita



ARMADI CON CASSETTI SERIE START



Gli armadi con cassetti Flexa sono una soluzione versatile e compatta per l'organizzazione di tutto il necessario per il lavoro. Sono caratterizzati da **serratura a cilindro centrale** e **cassetti con estrazione totale 100%** che possono avere una **portata variabile tra i 50 e i 70 kg**. L'interno dei **cassetti** è completamente personalizzabile grazie alla possibilità di poterlo suddividere tramite **divisori, cassette divisorio e vassoi portautensili 5S**. Il piano superiore può essere lasciato libero o protetto con un **piano a 3 bordi in PVC** per effettuare lavorazioni e operazioni.



PORTATA CASSETTI
DA 50 A 70 KG

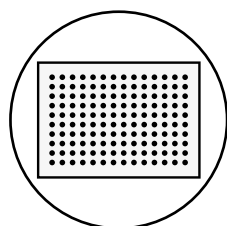

CASSETTI FORATI

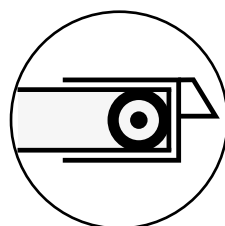

CUSCINETTI A SFERA

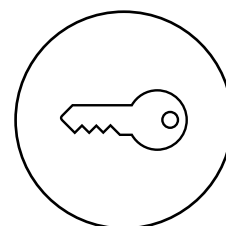

CHIUSURA A CHIAVE

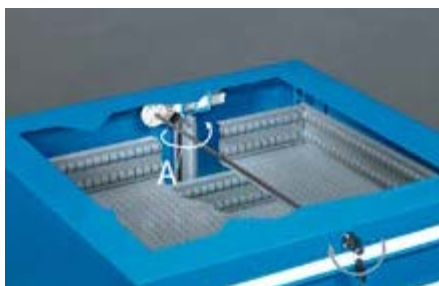

SERRATURA

La serratura a cilindro si collega tramite un'asta quadra al gruppo di chiusura posteriore composto di un elemento rotante in materiale plastico e un'asta di chiusura in lamiera di acciaio. Girando la chiave si aziona il sistema a camme del gruppo di chiusura che fa ruotare l'asta posteriore (A).



TOP A 3 BORDI RIVESTITO IN PVC

Il top a 3 bordi rivestito in PVC protegge la parte superiore dell'armadio e, grazie ai bordi rialzati, evita la caduta del materiale posizionato su di esso.



LIBERAMENTE ORGANIZZABILE

Il cassetto può essere suddiviso internamente tramite **cassette divisorio portaminuterie e divisori longitudinali e trasversali in metallo**. Quest'ultimi sono fissati al fondo forato del cassetto tramite viti per evitare la fuoriuscita del materiale stoccato.



CASSETTI FORATI



ORGANIZZAZIONE AL MILLIMETRO
Fori e scanalature sui cassetti facilitano la suddivisione interna del cassetto per una perfetta organizzazione di utensili e materiali.



ESTRAZIONE TOTALE
100%



PORTATA
50 / 70 KG

COLORI

L'armadio Flexa è disponibile in 3 combinazioni di colore.

ARMADIO



7016
7035



7035



5012

LEGENDA

EH		36x27 EH	54x27 EH
	Dimensioni armadio	L= 717	1023
		P= 600	600
	Dimensioni interne cassetto	L= 602	908
		P= 449	449



CONFIGURE

ARMADIO CON 7 CASSETTI 2X75 1X100 3X150 1X200

ART.	cassetti		RAL	€
	KG			
FDF109054PD	70	100%	7035+7016	732,00
FDF10905408	70	100%	7035	668,40
FDF10905404	70	100%	5012	668,40

H=1002 mm



CONFIGURE

ARMADIO CON 9 CASSETTI 9X100

ART.	cassetti		RAL	€
	KG			
FDF109056PD	70	100%	7035+7016	846,60
FDF10905608	70	100%	7035	776,70
FDF10905604	70	100%	5012	776,70

H=1002 mm



CONFIGURE

ARMADIO CON RUOTE CON 5 CASSETTI 4X100 1X200

ART.	cassetti		RAL	€
	KG			
FDGD56001PD	70	100%	7035+7016	659,10
FDGD5600108	70	100%	7035	620,70
FDGD5600104	70	100%	5012	620,70

H=853 mm

Ruote: Gomma standard Ø 100 mm
Portata armadio: 225 kg

MATERIALE DI SEPARAZIONE



TOP A 4 BORDI RIVESTITO IN PVC

ART.	L mm	P mm	H mm	colore	€
FDF99400107	717	602	22	Nero	67,20



ART.	adatto per cassetto H mm	componenti	€
FFH10051000	50/300	3 x Divisorio a 3 canali 9 x Divisorio a 4 canali 12 x Divisorio trasversale L=47 mm 36 x Divisorio trasversale L=36 mm	30,90



ART.	adatto per cassetto H mm	componenti	€
FFH10051300	50/300	18 x Divisorio trasversale L=47 mm 12 x Divisorio trasversale L=73 mm 6 x Divisorio a 2 canali 6 x Divisorio a 3 canali	27,90



ART.	adatto per cassetto H mm	componenti	€
FFH10051500	50/300	20 x Divisorio trasversale L=36 mm 20 x Divisorio trasversale L=47 mm 6 x Divisorio a 3 canali 5 x Divisorio a 4 canali 1 x Porta chiavi a brugola	30,90



ART.	adatto per cassetto H mm	componenti	€
FFH10071800	75	16 x Cassetta divisorio 75x75 mm 8 x Cassetta divisorio 150x75 mm 4 x Cassetta divisorio 150x150 mm	31,50



ART.	adatto per cassetto H mm	componenti	€
FFH10071600	75	12 x Cassetta divisorio 150x75 mm	28,80
FFH10101600	100/125	6 x Cassetta divisorio 150x150 mm	33,60



ART.	adatto per cassetto H mm	componenti	€
FFH10070500	75	2 x Divisorio longitudinale fessurato L=457 mm 3 x Divisorio trasversale L=202 mm	15,90
FFH10100500	100/125		16,50
FFH10150500	150/175		21,90
FFH10200500	200/250		31,20



PORTATA



ESTRAZIONE



RAL 7035 + RAL 7016



RAL 5012



RAL 7035



ARMADIO CON 7 CASSETTI 2X75 1X100 3X150 1X200

ART.	cassetti		RAL	€
	KG			
FDL109054PD	50	100%	7035+7016	897,60
FDL10905408	50	100%	7035	824,40
FDL10905404	50	100%	5012	824,40

H=1002 mm

CONFIGURE



ARMADIO CON 9 CASSETTI 9X100

ART.	cassetti		RAL	€
	KG			
FDL109056PD	50	100%	7035+7016	1050,30
FDL10905608	50	100%	7035	954,90
FDL10905604	50	100%	5012	954,90

H=1002 mm

CONFIGURE



MATERIALE DI SEPARAZIONE



TOP A 3 BORDI RIVESTITO IN PVC

ART.	L mm	P mm	H mm	colore	€
FDL91500107	1024	601	30	Nero	86,10



ART.	adatto per cassetto H mm	componenti	€
FFH40051200	50/300	15 x Divisorio trasversale L=36 mm 10 x Divisorio trasversale L=47 mm 6 x Divisorio trasversale L=73 mm 6 x Divisorio a 2 canali 6 x Divisorio a 3 canali 6 x Divisorio a 4 canali	38,40



ART.	adatto per cassetto H mm	componenti	€
FFH40051500	50/300	30 x Divisorio trasversale L=36 mm 10 x Divisorio trasversale L=47 mm 6 x Divisorio a 3 canali 12 x Divisorio a 4 canali	40,80



ART.	adatto per cassetto H mm	componenti	€
FFH40071100	75	18 x Cassetta divisorio 150x150 mm	41,10
FFH40101100	100/125		46,50



ART.	adatto per cassetto H mm	componenti	€
FFH40071300	75	12 x Cassetta divisorio 150x75 mm 12 x Cassetta divisorio 150x150 mm	42,90
FFH40101300	100/125		49,50



ART.	adatto per cassetto H mm	componenti	€
FFH40071600	75	20 x Cassetta divisorio 75x75 mm 14 x Cassetta divisorio 150x75 mm 6 x Cassetta divisorio 150x150 mm	47,40



ART.	adatto per cassetto H mm	componenti	€
FFH40070500	75	4 x Divisorio longitudinale fessurato L=457 mm 2 x Divisorio trasversale L=151 mm 3 x Divisorio trasversale L=202 mm	23,40
FFH40100500	100/125		27,00
FFH40150500	150/175		39,30
FFH40200500	200/250		57,60



PORTATA



ESTRAZIONE



RAL 7035 + RAL 7016



RAL 5012



RAL 7035

MASTER DE

ARMADI CON CASSETTI SERIE PRO



Gli armadi a cassette della linea Master DE rendono la custodia del materiale di lavoro altamente flessibile grazie alla possibilità di allestirli sia con **porte a battente e ripiani** che con **cassetti** con portata ed estrazione regolabile. In particolare, i cassetti possono avere un'**estrazione tra il 92% e il 100%** e una **portata tra i 50 e i 100 kg**. Inoltre, sono liberamente suddivisibili internamente con **divisori**, **cassette divisorio** e **vassoi portautensili**. Possono essere installati **top superiori** di varie tipologie oltre a **zoccoli** per rialzare l'armadio da terra.



**PORTATA CASSETTI
DA 50 A 100 KG**

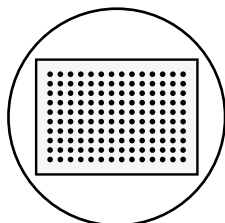

CASSETTI FORATI

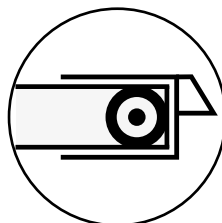

CUSCINETTI A SFERA

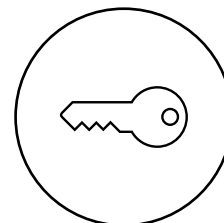

CHIUSURA A CHIAVE

MASTER DE



TOP IN ACCIAIO INOX SATINATO

Il top in acciaio inox satinato permette di effettuare lavorazioni e interventi senza danneggiare l'armadio. Presenta un elevato livello di resistenza alla corrosione e al calore.



TOP IN MULTIPLEX

Il top in multiplex trasforma la parte superiore dell'armadio in un piano di lavoro solido e robusto. È resistente a urti e graffi ed è adatto per operazioni pesanti.



TOP IN ACCIAIO GOMMATO

Il top è realizzato in acciaio zincato e rivestito con gomma antiolio. È particolarmente indicato in caso di uso di oli o per interventi che impiegano strumenti da taglio.



TOP A 3 BORDI RIVESTITO IN PVC

Il top a 3 bordi rivestito in PVC protegge la parte superiore dell'armadio e, grazie ai bordi rialzati, evita la caduta del materiale posizionato su di esso.



ZOCOLI

Gli zoccoli hanno una duplice funzione: rialzano l'armadio a cassetti dal pavimento e ne permettono la movimentazione tramite carrelli elevatori o transpallet.

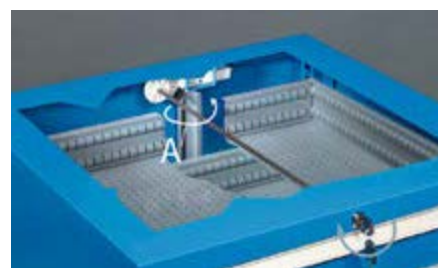

SERRATURA

La serratura a cilindro si collega tramite un'asta quadra al gruppo di chiusura posteriore composto di un elemento rotante in materiale plastico e un'asta di chiusura in lamiera di acciaio. Girando la chiave si aziona il sistema a camme del gruppo di chiusura che fa ruotare l'asta posteriore (A).



ESTRAZIONE TOTALE



LIBERTÀ NELLA CONFIGURAZIONE
Modifica velocemente e facilmente l'estrazione del cassetto per aumentare la portata fino a 100 kg.



GUIDE AD ALTE PRESTAZIONI



CORRERE SENZA PROBLEMI
Le guide lunghe come i cassetti permettono di spostare il cuscinetto nella parte frontale dell'armadio aumentando visibilità, portata ed estrazione.



CASSETTI FORATI



ORGANIZZAZIONE AL MILLIMETRO
Fori e scanalature sui cassetti facilitano la suddivisione interna del cassetto per una perfetta organizzazione di utensili e materiali.

MASTER DE

ESTRAZIONE E GESTIONE DEL CASSETTO

Il cassetto Master DE rappresenta una rivoluzione nel mondo dell'arredo industriale in quanto è stato ideato e sviluppato per essere personalizzato autonomamente in termini di estrazione/portata e suddivisione interna.



LIBERAMENTE CONFIGURABILE

La nuova guida ad **estrazione flessibile** permette la regolazione meccanica del fermo posteriore del cassetto/piano estraibile, in **3 diverse posizioni** ottenendo così **3 portate differenti: 50, 75, 100 kg**. Un'etichetta indica la portata massima del cassetto a seconda della sua estrazione e del tipo di guida.



GUIDA FLESSIBILE CONFIGURATA PER ESTRAZIONE TOTALE 50 KG

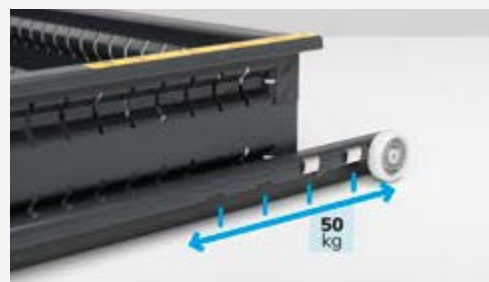
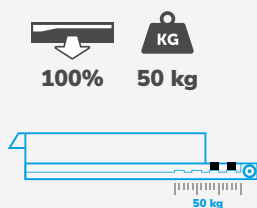

GUIDA FLESSIBILE CONFIGURATA PER ESTRAZIONE TOTALE 75 KG

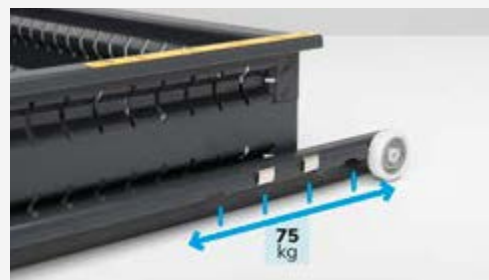
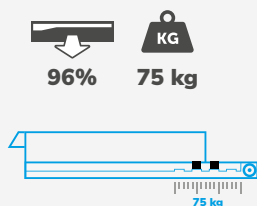

GUIDA FLESSIBILE CONFIGURATA PER ESTRAZIONE PARZIALE 100 KG

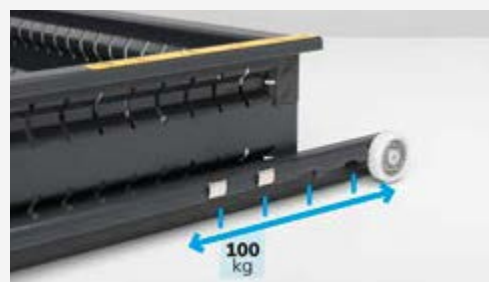
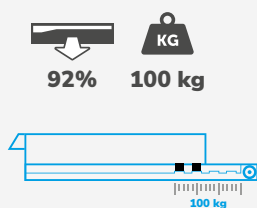

MASTER DE



Le innovazioni che semplificano l'identificazione dei contenuti all'interno dei cassetti.

Con la tecnologia Syfront di Sylogik® il frontale del cassetto non è più solo un elemento di chiusura, ma diventa una vera interfaccia visiva.

- Personalizzazione con elementi estetici e decorativi
- Input utente: etichette per la descrizione e catalogazione del contenuto
- Output utente: possibilità di inserire messaggi visivi o descrittivi sulla maniglia

MANIGLIE PERSONALIZZABILI

UNA MINIERA DI INFORMAZIONI

Inserisci nella maniglia codici a barre, etichette o immagini per conoscere velocemente il contenuto di ogni singolo cassetto.



COLORI

L'armadio Master DE è disponibile in 3 combinazioni di colore per il corpo armadio, mentre la maniglia è disponibile solo in Dark Grey.

ARMADIO



7016
7035



7035



5012

MANIGLIA FRONTALE



Dark Grey

LEGENDA

EH

36x36 EH **54x36 EH**



Dimensioni armadio

L=	714	1020
P=	726	726



Dimensioni interne cassetto

L=	602	908
P=	602	602

PR





Piano regolabile





CONFIGURE 

ARMADIO CON 6 CASSETTI 6X150





ART.	cassetti		RAL	€
	 KG			
 D33A100C01001PD	100-75-50	92-96-100%	7035+7016	843,60
 D33A100C0100108	100-75-50	92-96-100%	7035	804,00
 D33A100C0100104	100-75-50	92-96-100%	5012	804,00

H=1000 mm



CONFIGURE 

ARMADIO CON 7 CASSETTI 1X50 2X75 2X100 1X200 1X300





ART.	cassetti		RAL	€
	 KG			
 D33A100C01002PD	100-75-50	92-96-100%	7035+7016	924,60
 D33A100C0100208	100-75-50	92-96-100%	7035	862,50
 D33A100C0100204	100-75-50	92-96-100%	5012	862,50

H=1000 mm



CONFIGURE 

ARMADIO CON 8 CASSETTI 1X50 2X75 2X100 2X150 1X200





ART.	cassetti		RAL	€
	 KG			
 D33A100C01003PD	100-75-50	92-96-100%	7035+7016	996,60
 D33A100C0100308	100-75-50	92-96-100%	7035	930,90
 D33A100C0100304	100-75-50	92-96-100%	5012	930,90

H=1000 mm



CONFIGURE 

ARMADIO CON 9 CASSETTI 9X100

ART.	cassetti		RAL	€
	 KG			
 D33A100C01004PD	100-75-50	92-96-100%	7035+7016	1070,40
 D33A100C0100408	100-75-50	92-96-100%	7035	998,10
 D33A100C0100404	100-75-50	92-96-100%	5012	998,10

H=1000 mm

MATERIALE DI SEPARAZIONE



ART.	adatto per cassetto H mm	componenti	€
FFH20051500	50/300	35 x Divisorio trasversale L=73 mm 16 x Divisorio a 2 canali	34,20



ART.	adatto per cassetto H mm	componenti	€
FFH20051600	50/300	50 x Divisorio trasversale L=47 mm 16 x Divisorio a 3 canali	36,60



ART.	adatto per cassetto H mm	componenti	€
FFH20051700	50/300	65 x Divisorio trasversale L=36 mm 16 x Divisorio a 4 canali	39,90

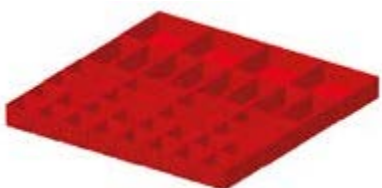

ART.	adatto per cassetto H mm	componenti	€
FFH20051200	50	16 x Cassetta divisorio 75x75 mm	31,50
FFH20071200	75	16 x Cassetta divisorio 150x75 mm 4 x Cassetta divisorio 150x150 mm	41,70

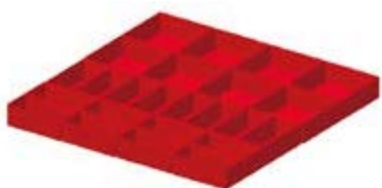

ART.	adatto per cassetto H mm	componenti	€
FFH20051300	50	16 x Cassetta divisorio 150x75 mm	27,60
FFH20071300	75	8 x Cassetta divisorio 150x150 mm	37,80
FFH20101300	100/125		44,10



ART.	adatto per cassetto H mm	componenti	€
FFH20050600	50	2 x Divisorio longitudinale fessurato L=610 mm 3 x Divisorio trasversale L=202 mm	15,00
FFH20070600	75		15,00
FFH20100600	100/125		17,10
FFH20150600	150/175		23,10
FFH20200600	200/250		35,10
FFH20300600	300		61,80



PORTATA



ESTRAZIONE



RAL 7035 + RAL 7016



RAL 5012





RAL 7035



CONFIGURE 

ARMADIO CON 6 CASSETTI 6X150

ART.	cassetti		RAL	€
				
 D53A100C01001PD	100-75-50	92-96-100%	7035+7016	1077,90
 D53A100C0100108	100-75-50	92-96-100%	7035	964,50
 D53A100C0100104	100-75-50	92-96-100%	5012	964,50

H=1000 mm



CONFIGURE 

ARMADIO CON 7 CASSETTI 1X50 2X75 2X100 1X200 1X300





ART.	cassetti		RAL	€
				
 D53A100C01002PD	100-75-50	92-96-100%	7035+7016	1158,30
 D53A100C0100208	100-75-50	92-96-100%	7035	1022,10
 D53A100C0100204	100-75-50	92-96-100%	5012	1022,10

H=1000 mm



CONFIGURE 

ARMADIO CON 8 CASSETTI 1X50 2X75 2X100 2X150 1X200

ART.	cassetti		RAL	€
				
 D53A100C01003PD	100-75-50	92-96-100%	7035+7016	1266,90
 D53A100C0100308	100-75-50	92-96-100%	7035	1109,40
 D53A100C0100304	100-75-50	92-96-100%	5012	1109,40

H=1000 mm



CONFIGURE 

ARMADIO CON PORTE 1XPR



ART.	n. porte	n. piano regolabile	RAL	€
 D53A100C01005PD	2	1	7035+7016	557,70
 D53A100C0100508	2	1	7035	557,70
 D53A100C0100504	2	1	5012	557,70

H=1000 mm



CONFIGURE 

ARMADIO CON PORTE 1XPR

ART.	n. porte	materiale porte	n. piano regolabile	RAL	€
 D53A100C01006PD	2	Polycarbonato	1	7035+7016	669,90
 D53A100C0100608	2	Polycarbonato	1	7035	669,90
 D53A100C0100604	2	Polycarbonato	1	5012	669,90

H=1000 mm



MATERIALE DI SEPARAZIONE



ART.	adatto per cassetto H mm	componenti	€
FFH50051900	50/300	30 x Divisorio trasversale L=36 mm 10 x Divisorio trasversale L=47 mm 8 x Divisorio a 3 canali 16 x Divisorio a 4 canali	48,60



ART.	adatto per cassetto H mm	componenti	€
FFH50050800	50	12 x Cassetta divisorio 150x75 mm 18 x Cassetta divisorio 150x150 mm	39,60
FFH50070800	75		53,40
FFH50100800	100/125		60,00



ART.	adatto per cassetto H mm	componenti	€
FFH50051700	50	20 x Cassetta divisorio 75x75 mm 14 x Cassetta divisorio 150x75 mm 12 x Cassetta divisorio 150x150 mm	43,80
FFH50071700	75		57,90



ART.	adatto per cassetto H mm	componenti	€
FFH50051800	50	24 x Cassetta divisorio 150x150 mm	38,10
FFH50071800	75		51,60
FFH50101800	100/125		57,00



ART.	adatto per cassetto H mm	componenti	€
FFH50051300	50	5 x Divisorio longitudinale fessurato L=610 mm 12 x Divisorio trasversale L=151 mm	29,70
FFH50071300	75		24,00
FFH50101300	100/125		30,00
FFH50151300	150/175		43,50
FFH50201300	200/250		75,30
FFH50301300	300		161,70



ART.	adatto per cassetto H mm	componenti	€
FFH50050700	50	4 x Divisorio longitudinale fessurato L=610 mm 2 x Divisorio trasversale L=151 mm 3 x Divisorio trasversale L=202 mm	22,80
FFH50070700	75		22,80
FFH50100700	100/125		25,80
FFH50150700	150/175		30,00
FFH50200700	200/250		53,40
FFH50300700	300		120,30



MASTER DE

ACCESSORI



TOP A 3 BORDI RIVESTITO IN PVC

ART.	adatto per armadio EH	L mm	P mm	H mm	colore	€
M33T023AG003107	36x36	715	729	23	Nero	86,10
M53T023AG003107	54x36	1021	729	23	Nero	88,50



TOP IN ACCIAIO INOX

ART.	adatto per armadio EH	L mm	P mm	H mm	€
M33T030MDNX710A	36x36	714	726	31	203,70
M53T030MDNX710A	54x36	1020	726	31	255,30



TOP IN ACCIAIO GOMMATO

ART.	adatto per armadio EH	L mm	P mm	H mm	colore	€
M33T030MDGM7107	36x36	714	726	32	Nero	164,10
M53T030MDGM7107	54x36	1020	726	32	Nero	226,80



TOP IN MULTIPLEX

ART.	adatto per armadio EH	L mm	P mm	H mm	€
M33T030MU000100	36x36	714	726	30	103,20
M53T030MU000100	54x36	1020	726	30	123,90



ZOCCOLO PER CARRELLO ELEVATORE E TRANSPALLET

ART.	adatto per armadio EH	L mm	P mm	H mm	RAL	€
M33Z10010000007	36x36	712	722	100	9005	96,30



CHIUSURA PER ZOCCOLO

ART.	adatto per armadio L EH	L mm	P mm	H mm	RAL	€
M30Z10011000007	36	708	46	95	9005	19,80



COPPIA ZOCCOLI PER CARRELLO ELEVATORE E TRANSPALLET

ART.	adatto per armadio EH	L mm	P mm	H mm	RAL	€
M03Z10020000007	54x36	200	722	100	9005	76,50



CHIUSURA PER ZOCCOLO

ART.	adatto per armadio L EH	L mm	P mm	H mm	RAL	€
M50Z10021000007	54	1014	46	95	9005	28,80

MASTER DE



vedi pag. 192

■
RAL 9005

MASTER

ARMADI CON CASSETTI SERIE PRO+



La cassettera porta utensili Master è versatile e può essere personalizzata in ogni minimo dettaglio per creare soluzioni che presentano non solo **cassetti o porte a battente e scorrevoli**, ma anche **piani estraibili e piani fessurati**. In base alla tipologia di guida installata su cassetti e piani è possibile avere un'**estrazione flessibile da 92 a 100%** con **portata tra i 50 e i 100 kg**, o un'**estrazione telescopica 100% con portata 200 kg**. Tutti i cassetti sono dotati di fori e fessure per l'installazione di **materiale di separazione e vassoi portautensili**, mentre il piano superiore può essere arricchito con **top** di vario tipo. La parte inferiore, invece, è predisposta per l'installazione di **ruote** oppure **zoccoli**.



**PORTATA CASSETTI
DA 50 A 200 KG**

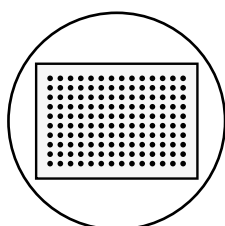

CASSETTI FORATI

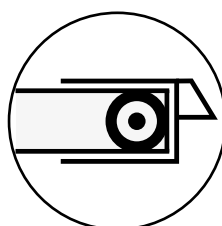

CUSCINETTI A SFERA

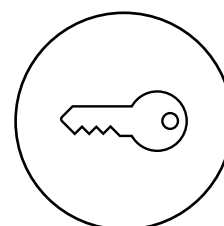

CHIUSURA A CHIAVE

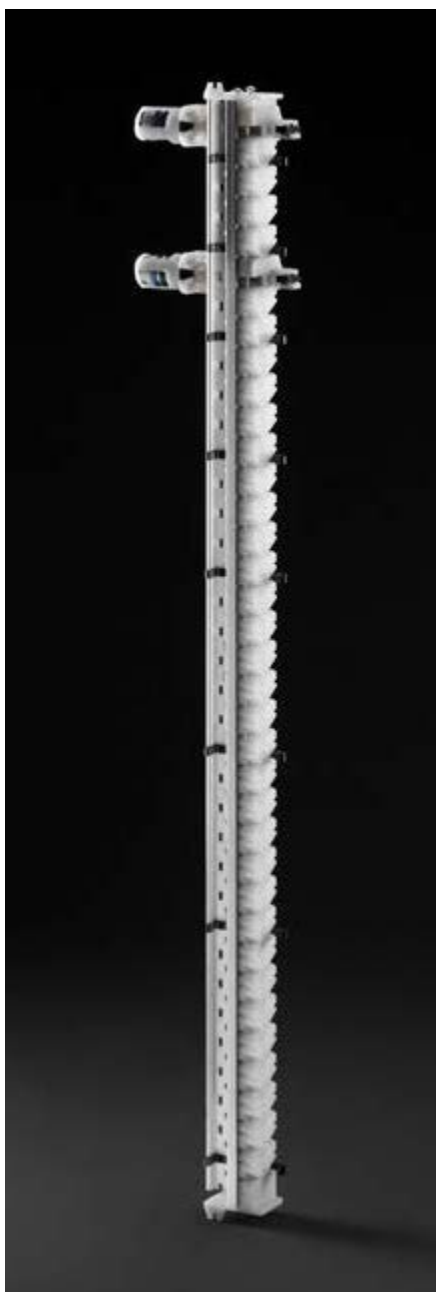

ASTA VERTEBRATA ANTIRIBALTAMENTO

L'asta è in profilato d'alluminio e rimane sempre fissa, senza ruotare.

Il movimento di chiusura è ottenuto da **tasselli che si spostano verticalmente** sfruttando una delle forze elementari della fisica: **la gravità. Più il movimento è semplice, meno probabilità di rotture ci sono.**

L'asta è forata a passo 25 mm e consente l'applicazione di più teste di chiusura. Questo permette di dividere l'accesso ai cassetti in più gruppi. La divisione dei gruppi è configurabile in altezza.

SISTEMA MECCANICO

Il sistema di comando meccanico del gruppo chiusura utilizza tecnologia Sylogik®. **Le differenze sono decisive.**

Il sistema di trasmissione dal cilindro della serratura alla testa dell'asta è costituito da fili di acciaio con guaina elastica e movimento lineare.

Rispetto ai comuni sistemi fissi ad asta quadra con movimento rotatorio, permette di svincolare il parallelismo della posizione del cilindro della serratura rispetto alla testa dell'asta. Questo consente al progettista di applicare il cilindro nel punto più idoneo dell'armadio.

Il cilindro della serratura è appoggiato a un tamburo di rinvio così da poter scegliere diverse case costruttrici di cilindri*.

In questo modo l'armadio può essere integrato con altri preesistenti mantenendo lo stesso tipo di chiave.

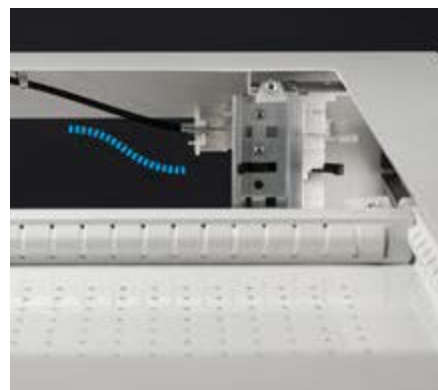

* Opzione a richiesta con sovrapprezzo



ESTRAZIONE TOTALE



LIBERTÀ NELLA CONFIGURAZIONE
Modifica velocemente e facilmente l'estrazione del cassetto per aumentare la portata fino a 100 kg.

GUIDE AD ALTE PRESTAZIONI



CORRERE SENZA PROBLEMI
Le guide lunghe come i cassetti permettono di spostare il cuscinetto nella parte frontale dell'armadio aumentando visibilità, portata ed estrazione.

CASSETTI FORATI



ORGANIZZAZIONE AL MILLIMETRO
Fori e scanalature sui cassetti facilitano la suddivisione interna del cassetto per una perfetta organizzazione di utensili e materiali.

MASTER

ESTRAZIONE E GESTIONE DEL CASSETTO

Il cassetto Master rappresenta una rivoluzione nel mondo dell'arredo industriale in quanto è stato ideato e sviluppato per essere personalizzato autonomamente in termini di estrazione/portata e suddivisione interna.



LIBERAMENTE CONFIGURABILE

La nuova guida ad **estrazione flessibile** permette la regolazione meccanica del fermo posteriore del cassetto/piano estraibile, in **3 diverse posizioni** ottenendo così **3 portate differenti: 50, 75, 100 kg**. L'installazione dell'innovativa **guida telescopica** aumenta la portata del **cassetto/piano estraibile fino a 200 kg**. Un'etichetta indica la portata massima del cassetto a seconda della sua estrazione e del tipo di guida.



GUIDA FLESSIBILE CONFIGURATA PER ESTRAZIONE TOTALE 50 KG

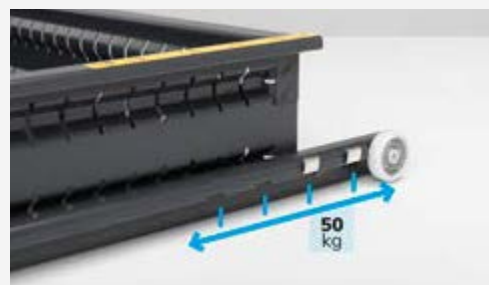
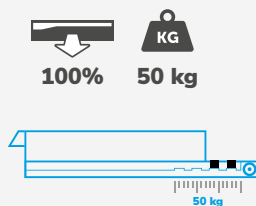

GUIDA FLESSIBILE CONFIGURATA PER ESTRAZIONE TOTALE 75 KG

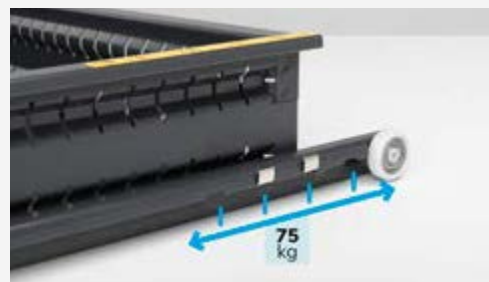
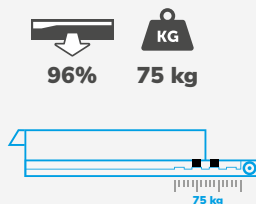

GUIDA FLESSIBILE CONFIGURATA PER ESTRAZIONE PARZIALE 100 KG

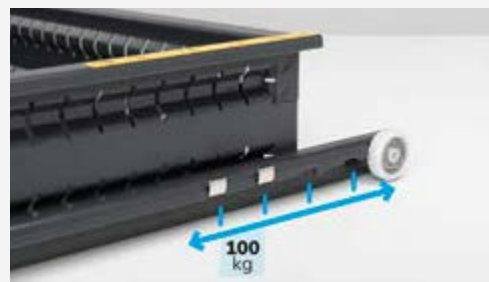
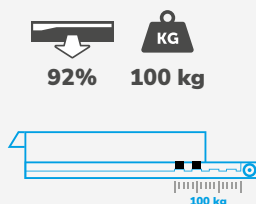

GUIDA TELESCOPICA CONFIGURATA PER ESTRAZIONE TOTALE 200 KG

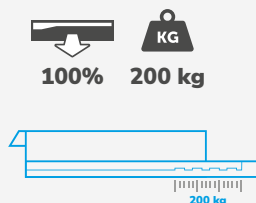

MASTER



Le innovazioni che semplificano l'identificazione dei contenuti all'interno dei cassetti.

Con la tecnologia Syfront di Sylogik® il frontale del cassetto non è più solo un elemento di chiusura, ma diventa una vera interfaccia visiva.

- Personalizzazione con elementi estetici e decorativi
- Input utente: etichette per la descrizione e catalogazione del contenuto
- Output utente: possibilità di inserire messaggi visivi o descrittivi sulla maniglia

MANIGLIE PERSONALIZZABILI

UNA MINIERA DI INFORMAZIONI

Inserisci nella maniglia codici a barre, etichette o immagini per conoscere velocemente il contenuto di ogni singolo cassetto.



MODULARITÀ

I diversi elementi che compongono la serie Master possono essere facilmente **integrati tra di loro per creare composizioni di arredo complete e pronte a tutto**. È possibile così creare, ad esempio, banconate con cassetti e porte corredate di piani a 4 bordi per effettuare manutenzioni e lavorazioni o per essere utilizzate come postazioni per accettazione clienti in negozi o magazzini.

Courtesy of Fridle Group



MASTER



TOP IN ACCIAIO INOX SATINATO

Il top in acciaio inox satinato permette di effettuare lavorazioni e interventi senza danneggiare l'armadio. Presenta un elevato livello di resistenza alla corrosione e al calore.



TOP IN MULTIPLEX

Il top in multiplex trasforma la parte superiore dell'armadio in un piano di lavoro solido e robusto. È resistente a urti e graffi ed è adatto per operazioni pesanti.



TOP IN ACCIAIO GOMMATO

Il top è realizzato in acciaio zincato e rivestito con gomma antiolio. È particolarmente indicato in caso di uso di oli o per interventi che impiegano strumenti da taglio.



TOP A 3 BORDI RIVESTITO IN PVC

Il top a 3 bordi rivestito in PVC protegge la parte superiore dell'armadio e, grazie ai bordi rialzati, evita la caduta del materiale posizionato su di esso.



ZOCCOLI

Gli zoccoli hanno una duplice funzione: rialzano l'armadio a cassette dal pavimento e ne permettono la movimentazione tramite carrelli elevatori o transpallet.



RUOTE

Gli armadi possono essere forniti con ruote per trasformarli in pratici carrelli portautensili. Di serie sono allestiti con 2 ruote girevoli con freno e 2 ruote fisse.



SISTEMA ANTIELUSIVO

SICUREZZA AL PRIMO POSTO
Al contrario di altri armadi presenti in commercio, il sistema di chiusura brevettato non consente allo scassinatore di eludere la chiusura. In caso di apertura forzata l'effrazione è sempre visibile.



MANIGLIA ERGONOMICA REGOLABILE

Gli armadi con ruote sono forniti con una pratica maniglia ergonomica regolabile che può essere installata in due diverse posizioni. L'altezza della maniglia potrà, quindi, essere impostata a seconda dell'altezza stessa dell'utilizzatore per consentire una movimentazione agile e facile dell'armadio e il mantenimento di una postura ergonomica al fine di ridurre gli sforzi durante il lavoro che potrebbero comportare possibili infortuni.



MASTER

COLORI

L'armadio Master è disponibile in 12 combinazioni di colore a cui associare 8 diversi colori per le maniglie per creare soluzioni personalizzate nel minimo dettaglio. È possibile, quindi, assegnare a particolari aree di lavoro o progetti colori specifici oppure implementare il colore aziendale anche negli arredi installati in azienda.

10 colori RAL per la parte metallica
8 colori per gli accessori plastici

Combinazioni infinite

MANIGLIA FRONTALE



Dark Grey



Mediterranean Blue



Sky Blue



Glamour Red



Red Carpet



Juicy Orange



Sunny Yellow



Forest Green

ARMADIO



7016
7035



7035



5012



9002



7016



7000



5019



9010



6011



3003



5010



5012
7035

LEGENDA

EH

18x27 EH 27x27 EH 36x27 EH 54x27 EH 27x36 EH 36x36 EH 45x36 EH 54x36 EH 64x36 EH 78x36 EH



Dimensioni armadio

L=	408	561	714	1020	561	714	867	1020	1190	1428
P=	573	573	573	573	726	726	726	726	726	726



Dimensioni interne cassetto

L=	296	449	602	908	449	602	755	908	1078	1316
P=	449	449	449	449	602	602	602	602	602	602

PE

Piano estraibile ad estrazione flessibile



PE

Piano estraibile ad estrazione telescopica



PR

Piano regolabile



PF

Piano regolabile fessurato





ARMADIO CON 3 CASSETTI 1X50 1X100 1X150



ART.	cassetti		RAL	€
	KG			
M12A040C01001PD	100-75-50	92-96-100%	7035+7016	575,10
M12A040C0100108	100-75-50	92-96-100%	7035	544,80
M12A040C0100104	100-75-50	92-96-100%	5012	544,80

CONFIGURE

H=400 mm



ARMADIO CON 3 CASSETTI 2X75 1X150



ART.	cassetti		RAL	€
	KG			
M12A040C01002PD	100-75-50	92-96-100%	7035+7016	561,60
M12A040C0100208	100-75-50	92-96-100%	7035	531,00
M12A040C0100204	100-75-50	92-96-100%	5012	531,00

CONFIGURE

H=400 mm



ARMADIO CON 4 CASSETTI 1X50 2X75 1X100



ART.	cassetti		RAL	€
	KG			
M12A040C01003PD	100-75-50	92-96-100%	7035+7016	658,20
M12A040C0100308	100-75-50	92-96-100%	7035	612,60
M12A040C0100304	100-75-50	92-96-100%	5012	612,60

CONFIGURE

H=400 mm



ARMADIO CON 4 CASSETTI 2X75 1X150 1X200



ART.	cassetti		RAL	€
	KG			
M12A060C01020PD	100-75-50	92-96-100%	7035+7016	676,80
M12A060C0102008	100-75-50	92-96-100%	7035	642,60
M12A060C0102004	100-75-50	92-96-100%	5012	642,60

CONFIGURE

H=600 mm



ARMADIO CON 3 CASSETTI 1X100 1X200 1X300



ART.	cassetti		RAL	€
	KG			
M12A070C01029PD	100-75-50	92-96-100%	7035+7016	631,50
M12A070C0102908	100-75-50	92-96-100%	7035	613,50
M12A070C0102904	100-75-50	92-96-100%	5012	613,50

CONFIGURE

H=700 mm



CONFIGURE

ARMADIO CON 5 CASSETTI 2X75 3X150

ART.	cassetti		RAL	€
M12A070C01035PD	100-75-50	92-96-100%	7035+7016	780,60
M12A070C0103508	100-75-50	92-96-100%	7035	734,40
M12A070C0103504	100-75-50	92-96-100%	5012	734,40

H=700 mm



CONFIGURE

ARMADIO CON RUOTE CON 4 CASSETTI 2X75 1X150 1X200

ART.	cassetti		RAL	€
M12R060C01020PD	100-75-50	92-96-100%	7035+7016	827,10
M12R060C0102008	100-75-50	92-96-100%	7035	793,20
M12R060C0102004	100-75-50	92-96-100%	5012	793,20

H=822 mm

Ruote: Gomma standard Ø 125 mm
Portata armadio: 300 kg



CONFIGURE

ARMADIO CON RUOTE CON 5 CASSETTI 1X50 2X75 1X100 1X200

ART.	cassetti		RAL	€
M12R060C01021PD	100-75-50	92-96-100%	7035+7016	924,00
M12R060C0102108	100-75-50	92-96-100%	7035	875,10
M12R060C0102104	100-75-50	92-96-100%	5012	875,10

H=822 mm

Ruote: Gomma standard Ø 125 mm
Portata armadio: 300 kg



CONFIGURE

ARMADIO CON RUOTE CON 6 CASSETTI 2X50 2X75 1X150 1X200

ART.	cassetti		RAL	€
M12R070C010SSPD	100-75-50	92-96-100%	7035+7016	1028,10
M12R070C010SS08	100-75-50	92-96-100%	7035	971,10
M12R070C010SS04	100-75-50	92-96-100%	5012	971,10

H=922 mm

Ruote: Gomma standard Ø 125 mm
Portata armadio: 300 kg



DIM. INTERNE LxP



PORTATA



ESTRAZIONE



RAL 7035 + RAL 7016



RAL 5012



RAL 7035



MATERIALE DI SEPARAZIONE



ART.	adatto per cassetto H mm	componenti	€
FFH82050200	50/300	16 x Divisorio trasversale L=36 mm 7 x Divisorio trasversale L=47 mm 3 x Divisorio a 3 canali 3 x Divisorio a 4 canali	12,60



ART.	adatto per cassetto H mm	componenti	€
FFH82050300	50/300	15 x Divisorio trasversale L=47 mm 8 x Divisorio trasversale L=73 mm 3 x Divisorio a 2 canali 3 x Divisorio a 3 canali	12,60



ART.	adatto per cassetto H mm	componenti	€
FFH82050400	50/300	18 x Divisorio trasversale L=73 mm 6 x Divisorio a 2 canali	12,00



ART.	adatto per cassetto H mm	componenti	€
FFH80050800	50	2 x Divisorio trasversale L=151 mm 1 x Divisorio longitudinale fessurato L=457 mm	4,80
FFH80070800	75		4,20
FFH80100800	100/125		6,00
FFH80150800	150/175		8,10
FFH80200800	200/250		13,20
FFH80300800	300		20,70



ART.	adatto per cassetto H mm	componenti	€
FFH80050900	50	2 x Divisorio longitudinale fessurato L=457 mm 6 x Divisorio trasversale L=100 mm	10,20
FFH80070900	75		9,30
FFH80100900	100/125		12,30
FFH80150900	150/175		17,10



ART.	adatto per cassetto H mm	componenti	€
FFH84051300	50	2 x Divisorio longitudinale non fessurato L=457 mm	8,40
FFH84071300	75		8,40
FFH84101300	100/125		9,00
FFH84151300	150/175		11,40
FFH84201300	200/250		13,20



MATERIALE DI SEPARAZIONE



ART.	adatto per cassetto H mm	componenti	€
FFH82051800	50	4 x Cassetta divisorio 150x75 mm 4 x Cassetta divisorio 150x150 mm	9,90
FFH82071800	75		12,30
FFH82101800	100/125		14,70



ART.	adatto per cassetto H mm	componenti	€
FFH82051700	50	4 x Cassetta divisorio 75x75 mm 6 x Cassetta divisorio 150x75 mm 2 x Cassetta divisorio 150x150 mm	10,80
FFH82071700	75		14,70

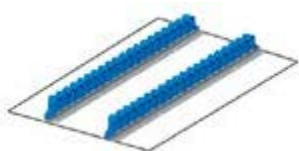

ART.	adatto per cassetto H mm	componenti	€
FFH86051900	50/300	2 x Portautensili multiuso	19,20





ARMADIO CON 2 CASSETTI 1X100 1X200



ART.	cassetti		RAL	€
	KG			
M22A040C01004PD	100-75-50	92-96-100%	7035+7016	438,60
M22A040C0100408	100-75-50	92-96-100%	7035	418,20
M22A040C0100404	100-75-50	92-96-100%	5012	418,20

CONFIGURE

H=400 mm



ARMADIO CON 3 CASSETTI 1X50 1X100 1X150



ART.	cassetti		RAL	€
	KG			
M22A040C01001PD	100-75-50	92-96-100%	7035+7016	516,30
M22A040C0100108	100-75-50	92-96-100%	7035	482,70
M22A040C0100104	100-75-50	92-96-100%	5012	482,70

CONFIGURE

H=400 mm



ARMADIO CON 4 CASSETTI 1X50 2X75 1X100



ART.	cassetti		RAL	€
	KG			
M22A040C01003PD	100-75-50	92-96-100%	7035+7016	594,90
M22A040C0100308	100-75-50	92-96-100%	7035	543,00
M22A040C0100304	100-75-50	92-96-100%	5012	543,00

CONFIGURE

H=400 mm



ARMADIO CON 6 CASSETTI 1X50 2X75 2X100 1X200



ART.	cassetti		RAL	€
	KG			
M22A070C01032PD	100-75-50	92-96-100%	7035+7016	811,50
M22A070C0103208	100-75-50	92-96-100%	7035	739,20
M22A070C0103204	100-75-50	92-96-100%	5012	739,20

CONFIGURE

H=700 mm



ARMADIO CON 4 CASSETTI 2X100 1X200 1X300



ART.	cassetti		RAL	€
	KG			
M22A080C01055PD	100-75-50	92-96-100%	7035+7016	676,20
M22A080C0105508	100-75-50	92-96-100%	7035	640,20
M22A080C0105504	100-75-50	92-96-100%	5012	640,20

CONFIGURE

H=800 mm



CONFIGURE

ARMADIO CON 5 CASSETTI 1X50 2X100 1X150 1X300



ART.	cassetti		RAL	€
M22A080C01054PD	100-75-50	92-96-100%	7035+7016	753,90
M22A080C0105408	100-75-50	92-96-100%	7035	704,70
M22A080C0105404	100-75-50	92-96-100%	5012	704,70

H=800 mm



CONFIGURE

ARMADIO CON 4 CASSETTI 1X100 1X150 1X200 1X300



ART.	cassetti		RAL	€
M22A085C01092PD	100-75-50	92-96-100%	7035+7016	685,80
M22A085C0109208	100-75-50	92-96-100%	7035	652,20
M22A085C0109204	100-75-50	92-96-100%	5012	652,20

H=850 mm



CONFIGURE

ARMADIO CON 5 CASSETTI 1X100 3X150 1X200



ART.	cassetti		RAL	€
M22A085C01088PD	100-75-50	92-96-100%	7035+7016	764,10
M22A085C0108808	100-75-50	92-96-100%	7035	717,00
M22A085C0108804	100-75-50	92-96-100%	5012	717,00

H=850 mm



CONFIGURE

ARMADIO CON 6 CASSETTI 2X75 2X100 2X200



ART.	cassetti		RAL	€
M22A085C01089PD	100-75-50	92-96-100%	7035+7016	847,20
M22A085C0108908	100-75-50	92-96-100%	7035	779,40
M22A085C0108904	100-75-50	92-96-100%	5012	779,40

H=850 mm



CONFIGURE

ARMADIO CON 6 CASSETTI 1X50 2X100 2X150 1X200



ART.	cassetti		RAL	€
M22A085C01091PD	100-75-50	92-96-100%	7035+7016	846,60
M22A085C0109108	100-75-50	92-96-100%	7035	783,60
M22A085C0109104	100-75-50	92-96-100%	5012	783,60

H=850 mm



DIM. INTERNE LxP



PORTATA



ESTRAZIONE



RAL 7035 + RAL 7016



RAL 5012



RAL 7035



CONFIGURE

ARMADIO CON 7 CASSETTI 2X75 3X100 2X150

ART.	cassetti		RAL	€
M22A085C01095PD	100-75-50	92-96-100%	7035+7016	926,70
M22A085C0109508	100-75-50	92-96-100%	7035	847,20
M22A085C0109504	100-75-50	92-96-100%	5012	847,20

H=850 mm



CONFIGURE

ARMADIO CON 8 CASSETTI 1X50 2X75 4X100 1X150

ART.	cassetti		RAL	€
M22A085C01087PD	100-75-50	92-96-100%	7035+7016	1009,20
M22A085C0108708	100-75-50	92-96-100%	7035	914,10
M22A085C0108704	100-75-50	92-96-100%	5012	914,10

H=850 mm



CONFIGURE

ARMADIO CON RUOTE CON 4 CASSETTI 2X75 1X150 1X200

ART.	cassetti		RAL	€
M22R060C01020PD	100-75-50	92-96-100%	7035+7016	816,00
M22R060C0102008	100-75-50	92-96-100%	7035	771,00
M22R060C0102004	100-75-50	92-96-100%	5012	771,00

H=822 mm

Ruote: Gomma standard Ø 125 mm
Portata armadio: 300 kg



CONFIGURE

ARMADIO CON RUOTE CON 5 CASSETTI 1X50 2X75 1X100 1X200

ART.	cassetti		RAL	€
M22R060C01021PD	100-75-50	92-96-100%	7035+7016	898,50
M22R060C0102108	100-75-50	92-96-100%	7035	837,60
M22R060C0102104	100-75-50	92-96-100%	5012	837,60

H=822 mm

Ruote: Gomma standard Ø 125 mm
Portata armadio: 300 kg



CONFIGURE

ARMADIO CON RUOTE CON 6 CASSETTI 2X50 2X75 1X150 1X200

ART.	cassetti		RAL	€
M22R070C010SSPD	100-75-50	92-96-100%	7035+7016	990,00
M22R070C010SS08	100-75-50	92-96-100%	7035	918,30
M22R070C010SS04	100-75-50	92-96-100%	5012	918,30

H=922 mm

Ruote: Gomma standard Ø 125 mm
Portata armadio: 300 kg



CONFIGURE

ARMADIO CON RUOTE CON 5 CASSETTI 4X100 1X200

ART.	cassetti		RAL	€
	KG	ESTRAZIONE		
M22R070C010GFPD	100-75-50	92-96-100%	7035+7016	924,00
M22R070C010GF08	100-75-50	92-96-100%	7035	869,10
M22R070C010GF04	100-75-50	92-96-100%	5012	869,10

H=922 mm

Ruote: Gomma standard Ø 125 mm
Portata armadio: 300 kg



CONFIGURE

ARMADIO CON RUOTE CON 6 CASSETTI 1X50 2X75 2X100 1X200

ART.	cassetti		RAL	€
	KG	ESTRAZIONE		
M22R070C01032PD	100-75-50	92-96-100%	7035+7016	996,30
M22R070C0103208	100-75-50	92-96-100%	7035	924,00
M22R070C0103204	100-75-50	92-96-100%	5012	924,00

H=922 mm

Ruote: Gomma standard Ø 125 mm
Portata armadio: 300 kg



CONFIGURE

ARMADIO CON RUOTE CON 6 CASSETTI 2X75 3X100 1X150

ART.	cassetti		RAL	€
	KG	ESTRAZIONE		
M22R070C01044PD	100-75-50	92-96-100%	7035+7016	997,80
M22R070C0104408	100-75-50	92-96-100%	7035	927,30
M22R070C0104404	100-75-50	92-96-100%	5012	927,30

H=922 mm

Ruote: Gomma standard Ø 125 mm
Portata armadio: 300 kg



DIM. INTERNE LxP



PORTATA



ESTRAZIONE



RAL 7035 + RAL 7016



RAL 5012



RAL 7035



MATERIALE DI SEPARAZIONE



ART.	adatto per cassetto H mm	componenti	€
FFH84050200	50/300	16 x Divisorio trasversale L=36 mm 7 x Divisorio trasversale L=47 mm 6 x Divisorio a 3 canali 3 x Divisorio a 4 canali	21,90



ART.	adatto per cassetto H mm	componenti	€
FFH84050300	50/300	15 x Divisorio trasversale L=47 mm 8 x Divisorio trasversale L=73 mm 6 x Divisorio a 2 canali 3 x Divisorio a 3 canali	21,90



ART.	adatto per cassetto H mm	componenti	€
FFH84050400	50/300	18 x Divisorio trasversale L=73 mm 9 x Divisorio a 2 canali	21,00



ART.	adatto per cassetto H mm	componenti	€
FFH84050800	50	2 x Divisorio longitudinale fessurato L=457 mm 3 x Divisorio trasversale L=151 mm	9,00
FFH84070800	75		12,90
FFH84100800	100/125		15,90
FFH84150800	150/175		20,40
FFH84200800	200/250		29,70
FFH84300800	300		38,70

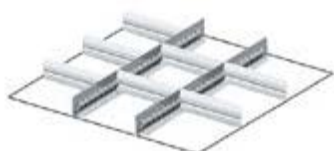

ART.	adatto per cassetto H mm	componenti	€
FFH84050900	50	2 x Divisorio longitudinale fessurato L=457 mm 7 x Divisorio trasversale L=151 mm	11,70
FFH84070900	75		10,80
FFH84100900	100/125		14,10
FFH84150900	150/175		19,50
FFH84200900	200/250		30,60

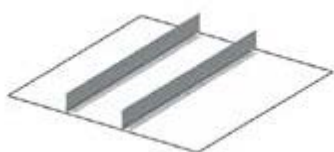

ART.	adatto per cassetto H mm	componenti	€
FFH84051300	50	2 x Divisorio longitudinale non fessurato L=457 mm	8,40
FFH84071300	75		8,40
FFH84101300	100/125		9,00
FFH84151300	150/175		11,40
FFH84201300	200/250		13,20



MATERIALE DI SEPARAZIONE



ART.	adatto per cassetto H mm	componenti	€
FFH84051700	50	8 x Cassetta divisorio 75x75 mm 6 x Cassetta divisorio 150x75 mm 4 x Cassetta divisorio 150x150 mm	16,20
FFH84071700	75		20,40



ART.	adatto per cassetto H mm	componenti	€
FFH84051800	50	6 x Cassetta divisorio 150x75 mm 6 x Cassetta divisorio 150x150 mm	14,40
FFH84071800	75		22,50
FFH84101800	100/125		24,60

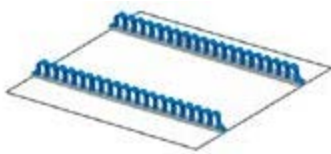

ART.	adatto per cassetto H mm	componenti	€
FFH86051900	50/300	2 x Portautensili multiuso	19,20





ARMADIO CON 5 CASSETTI 1X50 2X100 1X150 1X200



ART.	cassetti		RAL	€
M32A070C01040PD	100-75-50	92-96-100%	7035+7016	832,80
M32A070C0104008	100-75-50	92-96-100%	7035	771,00
M32A070C0104004	100-75-50	92-96-100%	5012	771,00

CONFIGURE

H=700 mm



ARMADIO CON 5 CASSETTI 2X75 2X100 1X250



ART.	cassetti		RAL	€
M32A070C01042PD	100-75-50	92-96-100%	7035+7016	834,90
M32A070C0104208	100-75-50	92-96-100%	7035	764,10
M32A070C0104204	100-75-50	92-96-100%	5012	764,10

CONFIGURE

H=700 mm



ARMADIO CON 6 CASSETTI 2X75 3X100 1X150



ART.	cassetti		RAL	€
M32A070C01044PD	100-75-50	92-96-100%	7035+7016	912,00
M32A070C0104408	100-75-50	92-96-100%	7035	831,60
M32A070C0104404	100-75-50	92-96-100%	5012	831,60

CONFIGURE

H=700 mm



ARMADIO CON 7 CASSETTI 1X50 2X75 2X100 1X150 1X200



ART.	cassetti		RAL	€
M32A085C010AEPD	100-75-50	92-96-100%	7035+7016	1026,30
M32A085C010AE08	100-75-50	92-96-100%	7035	935,40
M32A085C010AE04	100-75-50	92-96-100%	5012	935,40

CONFIGURE

H=850 mm



ARMADIO CON 7 CASSETTI 2X75 2X100 2X125 1X150



ART.	cassetti		RAL	€
M32A085C010ACPD	100-75-50	92-96-100%	7035+7016	1024,50
M32A085C010AC08	100-75-50	92-96-100%	7035	933,00
M32A085C010AC04	100-75-50	92-96-100%	5012	933,00

CONFIGURE

H=850 mm



ARMADIO CON 8 CASSETTI 4X75 3X100 1X150



ART.	cassetti		RAL	€
	KG			
M32A085C010AGPD	100-75-50	92-96-100%	7035+7016	1105,20
M32A085C010AG08	100-75-50	92-96-100%	7035	996,00
M32A085C010AG04	100-75-50	92-96-100%	5012	996,00

CONFIGURE

H=850 mm



ARMADIO CON 7 CASSETTI 1X50 2X75 2X100 1X200 1X300

ART.	cassetti		RAL	€
	KG			
M32A100C010BNPD	100-75-50	92-96-100%	7035+7016	1065,60
M32A100C010BN08	100-75-50	92-96-100%	7035	970,20
M32A100C010BN04	100-75-50	92-96-100%	5012	970,20

CONFIGURE

H=1000 mm



ARMADIO CON 7 CASSETTI 2X75 1X100 3X150 1X200

ART.	cassetti		RAL	€
	KG			
M32A100C010AWPD	100-75-50	92-96-100%	7035+7016	1047,90
M32A100C010AW08	100-75-50	92-96-100%	7035	966,30
M32A100C010AW04	100-75-50	92-96-100%	5012	966,30

CONFIGURE

H=1000 mm



ARMADIO CON 8 CASSETTI 1X50 2X75 3X100 1X150 1X250

ART.	cassetti		RAL	€
	KG			
M32A100C010BQPD	100-75-50	92-96-100%	7035+7016	1149,60
M32A100C010BQ08	100-75-50	92-96-100%	7035	1040,70
M32A100C010BQ04	100-75-50	92-96-100%	5012	1040,70

CONFIGURE

H=1000 mm



DIM. INTERNE LxP



PORTATA



ESTRAZIONE



RAL 7035 + RAL 7016



RAL 5012



RAL 7035



ARMADIO CON PORTE CON 1 CASSETTO 1X75 2XPE

ART.	cassetti / piani estraibili		RAL	€
	KG			
M32A100C010BUPD	100-75-50	92-96-100%	7035+7016	824,40
M32A100C010BU08	100-75-50	92-96-100%	7035	824,40
M32A100C010BU04	100-75-50	92-96-100%	5012	824,40
M32A100C010BVPD	200	100%	7035+7016	917,10
M32A100C010BV08	200	100%	7035	917,10
M32A100C010BV04	200	100%	5012	917,10

H=1022 mm

CONFIGURE



ARMADIO CON PORTE CON 2 CASSETTI 2X75 1XPE

ART.	cassetti / piani estraibili		RAL	€
	KG			
M32A100C010BWPD	100-75-50	92-96-100%	7035+7016	804,30
M32A100C010BW08	100-75-50	92-96-100%	7035	804,30
M32A100C010BW04	100-75-50	92-96-100%	5012	804,30
M32A100C010BXPD	200	100%	7035+7016	897,00
M32A100C010BX08	200	100%	7035	897,00
M32A100C010BX04	200	100%	5012	897,00

H=1022 mm

CONFIGURE



ARMADIO CON PORTE CON 3 CASSETTI 3X75 1XPE

ART.	cassetti / piani estraibili		RAL	€
	KG			
M32A100C010BYPD	100-75-50	92-96-100%	7035+7016	882,00
M32A100C010BY08	100-75-50	92-96-100%	7035	882,00
M32A100C010BY04	100-75-50	92-96-100%	5012	882,00
M32A100C010BZPD	200	100%	7035+7016	1005,60
M32A100C010BZ08	200	100%	7035	1005,60
M32A100C010BZ04	200	100%	5012	1005,60

H=1022 mm

CONFIGURE



ARMADIO CON PORTE CON 3 CASSETTI 3X75 2XPE

ART.	cassetti / piani estraibili		RAL	€
	KG			
M32A100C010CAPD	100-75-50	92-96-100%	7035+7016	979,50
M32A100C010CA08	100-75-50	92-96-100%	7035	979,50
M32A100C010CA04	100-75-50	92-96-100%	5012	979,50
M32A100C010CBPD	200	100%	7035+7016	1134,00
M32A100C010CB08	200	100%	7035	1134,00
M32A100C010CB04	200	100%	5012	1134,00

H=1022 mm

CONFIGURE



ARMADIO CON PORTE CON 4 CASSETTI 4X75



ART.	cassetti		RAL	€
	KG			
M32A100C010CCPD	100-75-50	92-96-100%	7035+7016	861,90
M32A100C010CC08	100-75-50	92-96-100%	7035	861,90
M32A100C010CC04	100-75-50	92-96-100%	5012	861,90
M32A100C010CDPD	200	100%	7035+7016	985,50
M32A100C010CD08	200	100%	7035	985,50
M32A100C010CD04	200	100%	5012	985,50

CONFIGURE

H=1022 mm



ARMADIO CON PORTE CON 5 CASSETTI 5X75

ART.	cassetti		RAL	€
	KG			
M32A100C010CEPD	100-75-50	92-96-100%	7035+7016	939,30
M32A100C010CE08	100-75-50	92-96-100%	7035	939,30
M32A100C010CE04	100-75-50	92-96-100%	5012	939,30
M32A100C010CFPD	200	100%	7035+7016	1093,80
M32A100C010CF08	200	100%	7035	1093,80
M32A100C010CF04	200	100%	5012	1093,80

CONFIGURE

H=1022 mm



ARMADIO CON PORTE SCORREVOLI CON 2 CASSETTI 2X75 6XPE

ART.	cassetti / piani estraibili		RAL	€
	KG			
M32D100C010GWPD	100-75-50	92-96-100%	7035+7016	2022,00
M32D100C010GW08	100-75-50	92-96-100%	7035	2022,00
M32D100C010GW04	100-75-50	92-96-100%	5012	2022,00
M32D100C010GXPD	200	100%	7035+7016	2269,20
M32D100C010GX08	200	100%	7035	2269,20
M32D100C010GX04	200	100%	5012	2269,20

CONFIGURE

H=1022 mm



ARMADIO CON PORTE SCORREVOLI CON 4 CASSETTI 4X75 2XPE

ART.	cassetti / piani estraibili		RAL	€
	KG			
M32D100C010GYPD	100-75-50	92-96-100%	7035+7016	1786,50
M32D100C010GY08	100-75-50	92-96-100%	7035	1786,50
M32D100C010GY04	100-75-50	92-96-100%	5012	1786,50
M32D100C010GZPD	200	100%	7035+7016	1971,90
M32D100C010GZ08	200	100%	7035	1971,90
M32D100C010GZ04	200	100%	5012	1971,90

CONFIGURE

H=1022 mm





ARMADIO CON PORTE SCORREVOLI CON 6 CASSETTI 6X75 2XPE



ART.	cassetti / piani estraibili		RAL	€
M32D100C010HAPD	100-75-50	92-96-100%	7035+7016	1941,90
M32D100C010HA08	100-75-50	92-96-100%	7035	1941,90
M32D100C010HA04	100-75-50	92-96-100%	5012	1941,90
M32D100C010HBPD	200	100%	7035+7016	2189,10
M32D100C010HB08	200	100%	7035	2189,10
M32D100C010HB04	200	100%	5012	2189,10

CONFIGURE

H=1022 mm

ARMADIO CON PORTE SCORREVOLI CON 8 CASSETTI 8X75



ART.	cassetti		RAL	€
M32D100C010HNPDP	100-75-50	92-96-100%	7035+7016	1901,70
M32D100C010HN08	100-75-50	92-96-100%	7035	1901,70
M32D100C010HN04	100-75-50	92-96-100%	5012	1901,70
M32D100C010HPPDP	200	100%	7035+7016	2148,90
M32D100C010HP08	200	100%	7035	2148,90
M32D100C010HP04	200	100%	5012	2148,90

CONFIGURE

H=1022 mm

ARMADIO CON PORTE SCORREVOLI CON 4 CASSETTI 4X75 4XPE



ART.	cassetti / piani estraibili		RAL	€
M32D100C010HEPD	100-75-50	92-96-100%	7035+7016	1981,80
M32D100C010HE08	100-75-50	92-96-100%	7035	1981,80
M32D100C010HE04	100-75-50	92-96-100%	5012	1981,80
M32D100C010HFPD	200	100%	7035+7016	2229,00
M32D100C010HF08	200	100%	7035	2229,00
M32D100C010HF04	200	100%	5012	2229,00

CONFIGURE

H=1022 mm

ARMADIO CON PORTE SCORREVOLI CON 10 CASSETTI 10X75



ART.	cassetti		RAL	€
M32D100C010HJPD	100-75-50	92-96-100%	7035+7016	2056,80
M32D100C010HJ08	100-75-50	92-96-100%	7035	2056,80
M32D100C010HJ04	100-75-50	92-96-100%	5012	2056,80
M32D100C010HKPD	200	100%	7035+7016	2365,80
M32D100C010HK08	200	100%	7035	2365,80
M32D100C010HK04	200	100%	5012	2365,80

CONFIGURE

H=1022 mm



ARMADIO CON 7 CASSETTI 2XPR 2X75 1X100 3X150 1X200

ART.	cassetti		RAL	€
M32A200C010FSPD	100-75-50	92-96-100%	7035+7016	1417,50
M32A200C010FS08	100-75-50	92-96-100%	7035	1335,90
M32A200C010FS04	100-75-50	92-96-100%	5012	1335,90
M32A200C010FTPD	200	100%	7035+7016	1633,80
M32A200C010FT08	200	100%	7035	1552,20
M32A200C010FT04	200	100%	5012	1552,20

H=2000 mm

CONFIGURE



ARMADIO CON PORTE CON 3 CASSETTI 2XPR 2X100 1X150 2XPE

ART.	cassetti / piani estraibili		RAL	€
M32A200C010FWPD	100-75-50	92-96-100%	7035+7016	1384,20
M32A200C010FW08	100-75-50	92-96-100%	7035	1384,20
M32A200C010FW04	100-75-50	92-96-100%	5012	1384,20
M32A200C010FXPD	200	100%	7035+7016	1538,70
M32A200C010FX08	200	100%	7035	1538,70
M32A200C010FX04	200	100%	5012	1538,70

H=2000 mm

CONFIGURE



ARMADIO CON PORTE CON 7 CASSETTI 3XPR 2X75 1X100 3X150 1X200

ART.	cassetti		RAL	€
M32A200C010FYPD	100-75-50	92-96-100%	7035+7016	1715,10
M32A200C010FY08	100-75-50	92-96-100%	7035	1633,50
M32A200C010FY04	100-75-50	92-96-100%	5012	1633,50
M32A200C010FZPD	200	100%	7035+7016	1931,40
M32A200C010FZ08	200	100%	7035	1849,80
M32A200C010FZ04	200	100%	5012	1849,80

H=2000 mm

CONFIGURE

PE: PIANO ESTRAIBILE
PR: PIANO REGOLABILE



DIM. INTERNE LxP



PORTATA



ESTRAZIONE



RAL 7035 + RAL 7016



RAL 5012



RAL 7035



CONFIGURE

ARMADIO CON RUOTE CON 5 CASSETTI 1X50 2X100 1X150 1X200



ART.	cassetti		RAL	€
M32R070C01040PD	100-75-50	92-96-100%	7035+7016	1023,60
M32R070C0104008	100-75-50	92-96-100%	7035	961,80
M32R070C0104004	100-75-50	92-96-100%	5012	961,80

H=922 mm

Ruote: Gomma standard Ø 125 mm
Portata armadio: 300 kg



CONFIGURE

ARMADIO CON RUOTE CON 5 CASSETTI 2X75 2X100 1X250



ART.	cassetti		RAL	€
M32R070C01042PD	100-75-50	92-96-100%	7035+7016	1026,00
M32R070C0104208	100-75-50	92-96-100%	7035	955,20
M32R070C0104204	100-75-50	92-96-100%	5012	955,20

H=922 mm

Ruote: Gomma standard Ø 125 mm
Portata armadio: 300 kg



CONFIGURE

ARMADIO CON RUOTE CON 6 CASSETTI 2X75 3X100 1X150



ART.	cassetti		RAL	€
M32R070C01044PD	100-75-50	92-96-100%	7035+7016	1102,80
M32R070C0104408	100-75-50	92-96-100%	7035	1022,40
M32R070C0104404	100-75-50	92-96-100%	5012	1022,40

H=922 mm

Ruote: Gomma standard Ø 125 mm
Portata armadio: 300 kg



CASSETTO H 50 mm

Set composto da 12 divisori a 4 canali e 65 divisori trasversali 36 mm



CASSETTO H 75 mm

Set di predisposizione per termoformati



CASSETTO H 200 mm

Set composto da 2 divisori longitudinali fessurati 455 mm e 3 divisori trasversali 200 mm



CASSETTO H 300 mm

Set composto da 1 divisorio longitudinale fessurato 455 mm

Utensili e termoformati esclusi



DIM. INTERNE LxP



PORTATA



ESTRAZIONE



RAL 7035 + RAL 7016



RAL 5012



RAL 7035



MATERIALE DI SEPARAZIONE



ART.	adatto per cassetto H mm	componenti	€
FFH10051500	50/300	20 x Divisorio trasversale L=36 mm 20 x Divisorio trasversale L=47 mm 6 x Divisorio a 3 canali 5 x Divisorio a 4 canali 1 x Porta chiavi a brugola	30,90



ART.	adatto per cassetto H mm	componenti	€
FFH10051000	50/300	3 x Divisorio a 3 canali 9 x Divisorio a 4 canali 12 x Divisorio trasversale L=47 mm 36 x Divisorio trasversale L=36 mm	30,90



ART.	adatto per cassetto H mm	componenti	€
FFH10051300	50/300	18 x Divisorio trasversale L=47 mm 12 x Divisorio trasversale L=73 mm 6 x Divisorio a 2 canali 6 x Divisorio a 3 canali	27,90



ART.	adatto per cassetto H mm	componenti	€
FFH10052100	50/300	12 x Divisorio a 4 canali 65 x Divisorio trasversale L=36 mm	45,90



ART.	adatto per cassetto H mm	componenti	€
FFH10051600	50	12 x Cassetta divisorio 150x75 mm 6 x Cassetta divisorio 150x150 mm	19,80
FFH10071600	75		28,80
FFH10101600	100/125		33,60



ART.	adatto per cassetto H mm	componenti	€
FFH10051800	50	16 x Cassetta divisorio 75x75 mm 8 x Cassetta divisorio 150x75 mm 4 x Cassetta divisorio 150x150 mm	22,50
FFH10071800	75		31,50



MATERIALE DI SEPARAZIONE



ART.	adatto per cassetto H mm	componenti	€
FFH10050500	50	2 x Divisorio longitudinale fessurato L=457 mm 3 x Divisorio trasversale L=202 mm	9,90
FFH10070500	75		15,90
FFH10100500	100/125		16,50
FFH10150500	150/175		21,90
FFH10200500	200/250		31,20
FFH10300500	300		42,90



ART.	adatto per cassetto H mm	componenti	€
FFH10050300	50	3 x Divisorio longitudinale fessurato L=457 mm 8 x Divisorio trasversale L=151 mm	15,90
FFH10070300	75		14,10
FFH10100300	100/125		19,20
FFH10150300	150/175		26,40
FFH10200300	200/250		42,00



ART.	adatto per cassetto H mm	componenti	€
FFH10052200	50	5 x Divisorio longitudinale fessurato L=457 mm 18 x Divisorio trasversale L=100 mm	31,20
FFH10072200	75		31,20
FFH10102200	100/125		41,40
FFH10152200	150/175		54,60



ART.	adatto per cassetto H mm	componenti	€
FFH84051300	50	2 x Divisorio longitudinale non fessurato L=457 mm	8,40
FFH84071300	75		8,40
FFH84101300	100/125		9,00
FFH84151300	150/175		11,40
FFH84201300	200/250		13,20





ARMADIO CON 5 CASSETTI 3X100 1X150 1X300



ART.	cassetti		RAL	€
M52A085C010AKPD	100-75-50	92-96-100%	7035+7016	1012,80
M52A085C010AK08	100-75-50	92-96-100%	7035	954,60
M52A085C010AK04	100-75-50	92-96-100%	5012	954,60
M52A085C010ALPD	200	100%	7035+7016	1167,30
M52A085C010AL08	200	100%	7035	1109,10
M52A085C010AL04	200	100%	5012	1109,10

CONFIGURE

H=850 mm

ARMADIO CON 6 CASSETTI 2X75 2X100 1X150 1X250



ART.	cassetti		RAL	€
M52A085C010AMPD	100-75-50	92-96-100%	7035+7016	1108,50
M52A085C010AM08	100-75-50	92-96-100%	7035	1031,40
M52A085C010AM04	100-75-50	92-96-100%	5012	1031,40
M52A085C010ANPD	200	100%	7035+7016	1293,90
M52A085C010AN08	200	100%	7035	1216,80
M52A085C010AN04	200	100%	5012	1216,80

CONFIGURE

H=850 mm

ARMADIO CON 7 CASSETTI 1X50 2X75 2X100 1X150 1X200



ART.	cassetti		RAL	€
M52A085C010AEPD	100-75-50	92-96-100%	7035+7016	1213,20
M52A085C010AE08	100-75-50	92-96-100%	7035	1117,80
M52A085C010AE04	100-75-50	92-96-100%	5012	1117,80
M52A085C010AFPD	200	100%	7035+7016	1398,60
M52A085C010AF08	200	100%	7035	1303,20
M52A085C010AF04	200	100%	5012	1303,20

CONFIGURE

H=850 mm I cassetti H=50 mm hanno sempre estrazione flessibile

ARMADIO CON 6 CASSETTI 3X100 2X150 1X300



ART.	cassetti		RAL	€
M52A100C010CQPD	100-75-50	92-96-100%	7035+7016	1163,70
M52A100C010CQ08	100-75-50	92-96-100%	7035	1094,40
M52A100C010CQ04	100-75-50	92-96-100%	5012	1094,40
M52A100C010CRPD	200	100%	7035+7016	1349,10
M52A100C010CR08	200	100%	7035	1279,80
M52A100C010CR04	200	100%	5012	1279,80

CONFIGURE

H=1000 mm



ARMADIO CON 7 CASSETTI 2X75 1X100 3X150 1X200



ART.	cassetti		RAL	€
	KG			
M52A100C010AWPD	100-75-50	92-96-100%	7035+7016	1260,90
M52A100C010AW08	100-75-50	92-96-100%	7035	1174,20
M52A100C010AW04	100-75-50	92-96-100%	5012	1174,20
M52A100C010BHPD	200	100%	7035+7016	1477,20
M52A100C010BH08	200	100%	7035	1390,50
M52A100C010BH04	200	100%	5012	1390,50

CONFIGURE

H=1000 mm

ARMADIO CON 8 CASSETTI 2X75 4X100 1X150 1X200



ART.	cassetti		RAL	€
	KG			
M52A100C010CNPD	100-75-50	92-96-100%	7035+7016	1364,40
M52A100C010CN08	100-75-50	92-96-100%	7035	1260,30
M52A100C010CN04	100-75-50	92-96-100%	5012	1260,30
M52A100C010CPPD	200	100%	7035+7016	1611,60
M52A100C010CP08	200	100%	7035	1507,50
M52A100C010CP04	200	100%	5012	1507,50

CONFIGURE

H=1000 mm

ARMADIO CON 9 CASSETTI 2X75 2X100 1X150 3X200 1X300



ART.	cassetti		RAL	€
	KG			
M52A150C010FLPD	100-75-50	92-96-100%	7035+7016	1648,80
M52A150C010FL08	100-75-50	92-96-100%	7035	1542,30
M52A150C010FL04	100-75-50	92-96-100%	5012	1542,30
M52A150C010FMPD	200	100%	7035+7016	1926,90
M52A150C010FM08	200	100%	7035	1820,40
M52A150C010FM04	200	100%	5012	1820,40

CONFIGURE

H=1500 mm

ARMADIO CON 10 CASSETTI 2X75 3X100 1X150 4X200



ART.	cassetti		RAL	€
	KG			
M52A150C010FNPD	100-75-50	92-96-100%	7035+7016	1756,80
M52A150C010FN08	100-75-50	92-96-100%	7035	1635,90
M52A150C010FN04	100-75-50	92-96-100%	5012	1635,90
M52A150C010FPPD	200	100%	7035+7016	2065,80
M52A150C010FP08	200	100%	7035	1944,90
M52A150C010FP04	200	100%	5012	1944,90

CONFIGURE

H=1500 mm



DIM. INTERNE LxP



PORTATA



ESTRAZIONE



RAL 7035 + RAL 7016



RAL 5012



RAL 7035



ARMADIO CON 11 CASSETTI 2X75 4X100 3X150 2X200

ART.	cassetti		RAL	€
M52A150C010FQPD	100-75-50	92-96-100%	7035+7016	1862,70
M52A150C010FQ08	100-75-50	92-96-100%	7035	1727,10
M52A150C010FQ04	100-75-50	92-96-100%	5012	1727,10
M52A150C010FRPD	200	100%	7035+7016	2202,60
M52A150C010FR08	200	100%	7035	2067,00
M52A150C010FR04	200	100%	5012	2067,00

CONFIGURE

H=1500 mm



ARMADIO CON 7 CASSETTI 2XPR 2X75 1X100 3X150 1X200

ART.	cassetti		RAL	€
M52A200C010FSPD	100-75-50	92-96-100%	7035+7016	1664,10
M52A200C010FS08	100-75-50	92-96-100%	7035	1577,10
M52A200C010FS04	100-75-50	92-96-100%	5012	1577,10
M52A200C010FTPD	200	100%	7035+7016	1880,40
M52A200C010FT08	200	100%	7035	1793,40
M52A200C010FT04	200	100%	5012	1793,40

CONFIGURE

H=2000 mm



ARMADIO CON PORTE CON 3 CASSETTI 2XPR 2X100 1X150 2XPE

ART.	cassetti / piani estraibili		RAL	€
M52A200C010FWPD	100-75-50	92-96-100%	7035+7016	1586,40
M52A200C010FW08	100-75-50	92-96-100%	7035	1586,40
M52A200C010FW04	100-75-50	92-96-100%	5012	1586,40
M52A200C010FXPD	200	100%	7035+7016	1740,90
M52A200C010FX08	200	100%	7035	1740,90
M52A200C010FX04	200	100%	5012	1740,90

CONFIGURE

H=2000 mm



ARMADIO CON PORTE CON 7 CASSETTI 3XPR 2X75 1X100 3X150 1X200



ART.	cassetti		RAL	€
M52A200C010FYPD	100-75-50	92-96-100%	7035+7016	2007,90
M52A200C010FY08	100-75-50	92-96-100%	7035	1921,20
M52A200C010FY04	100-75-50	92-96-100%	5012	1921,20
M52A200C010FZPD	200	100%	7035+7016	2224,20
M52A200C010FZ08	200	100%	7035	2137,50
M52A200C010FZ04	200	100%	5012	2137,50

H=2000 mm

CONFIGURE



CONFIGURE

ARMADIO CON RUOTE CON 4 CASSETTI 1X100 2X150 1X200



ART.	cassetti		RAL	€
M52R070C01049PD	100-75-50	92-96-100%	7035+7016	1153,20
M52R070C0104908	100-75-50	92-96-100%	7035	1108,80
M52R070C0104904	100-75-50	92-96-100%	5012	1108,80

H=922 mm

Ruote: Gomma elastica Ø 125 mm
Portata armadio: 750 kg



CONFIGURE

ARMADIO CON RUOTE CON 5 CASSETTI 2X75 1X100 1X150 1X200



ART.	cassetti		RAL	€
M52R070C01031PD	100-75-50	92-96-100%	7035+7016	1246,20
M52R070C0103108	100-75-50	92-96-100%	7035	1181,10
M52R070C0103104	100-75-50	92-96-100%	5012	1181,10

H=922 mm

Ruote: Gomma elastica Ø 125 mm
Portata armadio: 750 kg



CONFIGURE

ARMADIO CON RUOTE CON 6 CASSETTI 2X75 3X100 1X150



ART.	cassetti		RAL	€
M52R070C01044PD	100-75-50	92-96-100%	7035+7016	1350,90
M52R070C0104408	100-75-50	92-96-100%	7035	1269,60
M52R070C0104404	100-75-50	92-96-100%	5012	1269,60

H=922 mm

Ruote: Gomma elastica Ø 125 mm
Portata armadio: 750 kg





MATERIALE DI SEPARAZIONE



ART.	adatto per cassetto H mm	componenti	€
FFH40051200	50/300	15 x Divisorio trasversale L=36 mm 10 x Divisorio trasversale L=47 mm 6 x Divisorio trasversale L=73 mm 6 x Divisorio a 2 canali 6 x Divisorio a 3 canali 6 x Divisorio a 4 canali	38,40



ART.	adatto per cassetto H mm	componenti	€
FFH40051500	50/300	30 x Divisorio trasversale L=36 mm 10 x Divisorio trasversale L=47 mm 6 x Divisorio a 3 canali 12 x Divisorio a 4 canali	40,80



ART.	adatto per cassetto H mm	componenti	€
FFH40051100	50	18 x Cassetta divisorio 150x150 mm	27,60
FFH40071100	75		41,10
FFH40101100	100/125		46,50



ART.	adatto per cassetto H mm	componenti	€
FFH40051300	50	12 x Cassetta divisorio 150x75 mm 12 x Cassetta divisorio 150x150 mm	29,10
FFH40071300	75		42,90
FFH40101300	100/125		49,50



ART.	adatto per cassetto H mm	componenti	€
FFH40051600	50	20 x Cassetta divisorio 75x75 mm 14 x Cassetta divisorio 150x75 mm 6 x Cassetta divisorio 150x150 mm	33,30
FFH40071600	75		47,40



ART.	adatto per cassetto H mm	componenti	€
FFH40050300	50	5 x Divisorio longitudinale fessurato L=457 mm 12 x Divisorio trasversale L=151 mm	24,90
FFH40070300	75		23,10
FFH40100300	100/125		30,90
FFH40150300	150/175		42,30
FFH40200300	200/250		68,10



MATERIALE DI SEPARAZIONE



ART.	adatto per cassetto H mm	componenti	€
FFH40050500	50	4 x Divisorio longitudinale fessurato L=457 mm 2 x Divisorio trasversale L=151 mm 3 x Divisorio trasversale L=202 mm	18,00
FFH40070500	75		23,40
FFH40100500	100/125		27,00
FFH40150500	150/175		39,30
FFH40200500	200/250		57,60



ART.	adatto per cassetto H mm	componenti	€
FFH40052000	50	2 x Divisorio longitudinale fessurato L=457 mm 2 x Divisorio trasversale L=304 mm	9,90
FFH40072000	75		10,50
FFH40102000	100/125		13,50
FFH40152000	150/175		18,00
FFH40202000	200/250		26,70
FFH40302000	300		45,00



ART.	adatto per cassetto H mm	componenti	€
FFH40050600	50	7 x Divisorio longitudinale fessurato L=457 mm 12 x Divisorio trasversale L=100 mm 2 x Divisorio trasversale L=151 mm	36,90
FFH40070600	75		37,50
FFH40100600	100/125		48,30





ARMADIO CON 1 CASSETTO 1X100

ART.	cassetti		RAL	€
M23A020C01005PD	100-75-50	92-96-100%	7035+7016	272,70
M23A020C0100508	100-75-50	92-96-100%	7035	261,90
M23A020C0100504	100-75-50	92-96-100%	5012	261,90

CONFIGURE

H=200 mm



ARMADIO CON 1 CASSETTO 1X200

ART.	cassetti		RAL	€
M23A030C01006PD	100-75-50	92-96-100%	7035+7016	287,10
M23A030C0100608	100-75-50	92-96-100%	7035	282,90
M23A030C0100604	100-75-50	92-96-100%	5012	282,90

CONFIGURE

H=300 mm



ARMADIO CON 3 CASSETTI 1X50 1X100 1X150

ART.	cassetti		RAL	€
M23A040C01001PD	100-75-50	92-96-100%	7035+7016	525,00
M23A040C0100108	100-75-50	92-96-100%	7035	493,50
M23A040C0100104	100-75-50	92-96-100%	5012	493,50

CONFIGURE

H=400 mm



ARMADIO CON 3 CASSETTI 2X75 1X150

ART.	cassetti		RAL	€
M23A040C01002PD	100-75-50	92-96-100%	7035+7016	517,50
M23A040C0100208	100-75-50	92-96-100%	7035	488,10
M23A040C0100204	100-75-50	92-96-100%	5012	488,10

CONFIGURE

H=400 mm



ARMADIO CON 4 CASSETTI 2X75 1X150 1X200

ART.	cassetti		RAL	€
M23A060C01020PD	100-75-50	92-96-100%	7035+7016	617,40
M23A060C0102008	100-75-50	92-96-100%	7035	584,10
M23A060C0102004	100-75-50	92-96-100%	5012	584,10

CONFIGURE

H=600 mm



CONFIGURE

ARMADIO CON 5 CASSETTI 1X50 2X75 1X100 1X200



ART.	cassetti		RAL	€
M23A060C01021PD	100-75-50	92-96-100%	7035+7016	696,00
M23A060C0102108	100-75-50	92-96-100%	7035	647,70
M23A060C0102104	100-75-50	92-96-100%	5012	647,70

H=600 mm



CONFIGURE

ARMADIO CON 5 CASSETTI 2X75 1X100 1X150 1X200



ART.	cassetti		RAL	€
M23A070C01031PD	100-75-50	92-96-100%	7035+7016	720,60
M23A070C0103108	100-75-50	92-96-100%	7035	676,50
M23A070C0103104	100-75-50	92-96-100%	5012	676,50

H=700 mm



CONFIGURE

ARMADIO CON 4 CASSETTI 1X100 2X150 1X200



ART.	cassetti		RAL	€
M23A070C01049PD	100-75-50	92-96-100%	7035+7016	649,50
M23A070C0104908	100-75-50	92-96-100%	7035	618,00
M23A070C0104904	100-75-50	92-96-100%	5012	618,00

H=700 mm



CONFIGURE

ARMADIO CON 6 CASSETTI 1X50 2X75 2X100 1X200



ART.	cassetti		RAL	€
M23A070C01032PD	100-75-50	92-96-100%	7035+7016	799,20
M23A070C0103208	100-75-50	92-96-100%	7035	740,10
M23A070C0103204	100-75-50	92-96-100%	5012	740,10

H=700 mm



CONFIGURE

ARMADIO CON 4 CASSETTI 2X100 1X200 1X300



ART.	cassetti		RAL	€
M23A080C01055PD	100-75-50	92-96-100%	7035+7016	673,80
M23A080C0105508	100-75-50	92-96-100%	7035	640,80
M23A080C0105504	100-75-50	92-96-100%	5012	640,80

H=800 mm



DIM. INTERNE LxP



PORTATA



ESTRAZIONE



RAL 7035 + RAL 7016



RAL 5012



RAL 7035



ARMADIO CON 5 CASSETTI 1X50 2X100 1X150 1X300



ART.	cassetti		RAL	€
M23A080C01054PD	100-75-50	92-96-100%	7035+7016	747,00
M23A080C0105408	100-75-50	92-96-100%	7035	697,20
M23A080C0105404	100-75-50	92-96-100%	5012	697,20

CONFIGURE

H=800 mm



ARMADIO CON 6 CASSETTI 2X75 2X100 1X150 1X200



ART.	cassetti		RAL	€
M23A080C01056PD	100-75-50	92-96-100%	7035+7016	815,40
M23A080C0105608	100-75-50	92-96-100%	7035	760,50
M23A080C0105604	100-75-50	92-96-100%	5012	760,50

CONFIGURE

H=800 mm



ARMADIO CON 7 CASSETTI 1X50 2X75 2X100 2X150



ART.	cassetti		RAL	€
M23A080C01066PD	100-75-50	92-96-100%	7035+7016	888,30
M23A080C0106608	100-75-50	92-96-100%	7035	816,60
M23A080C0106604	100-75-50	92-96-100%	5012	816,60

CONFIGURE

H=800 mm



ARMADIO CON 7 CASSETTI 2X75 4X100 1X150



ART.	cassetti		RAL	€
M23A080C01065PD	100-75-50	92-96-100%	7035+7016	894,90
M23A080C0106508	100-75-50	92-96-100%	7035	822,30
M23A080C0106504	100-75-50	92-96-100%	5012	822,30

CONFIGURE

H=800 mm



ARMADIO CON PORTA CON 1 CASSETTO 1X75 1XPR 1XPE



ART.	cassetti/piani estraibili		RAL	€
M23A080C01069PD	100-75-50	92-96-100%	7035+7016	641,10
M23A080C0106908	100-75-50	92-96-100%	7035	630,60
M23A080C0106904	100-75-50	92-96-100%	5012	630,60

CONFIGURE

H=800 mm



CONFIGURE

ARMADIO CON 4 CASSETTI 3X150 1X300



ART.	cassetti		RAL	€
M23A085C010AQPDP	100-75-50	92-96-100%	7035+7016	680,10
M23A085C010AQ08	100-75-50	92-96-100%	7035	647,70
M23A085C010AQ04	100-75-50	92-96-100%	5012	647,70

H=850 mm



CONFIGURE

ARMADIO CON 5 CASSETTI 1X50 2X100 1X200 1X300



ART.	cassetti		RAL	€
M23A085C01093PD	100-75-50	92-96-100%	7035+7016	764,10
M23A085C0109308	100-75-50	92-96-100%	7035	718,80
M23A085C0109304	100-75-50	92-96-100%	5012	718,80

H=850 mm



CONFIGURE

ARMADIO CON 5 CASSETTI 2X100 1X150 2X200



ART.	cassetti		RAL	€
M23A085C01090PD	100-75-50	92-96-100%	7035+7016	761,70
M23A085C0109008	100-75-50	92-96-100%	7035	723,60
M23A085C0109004	100-75-50	92-96-100%	5012	723,60

H=850 mm



CONFIGURE

ARMADIO CON 6 CASSETTI 1X75 3X100 1X125 1X250



ART.	cassetti		RAL	€
M23A085C01094PD	100-75-50	92-96-100%	7035+7016	837,90
M23A085C0109408	100-75-50	92-96-100%	7035	780,60
M23A085C0109404	100-75-50	92-96-100%	5012	780,60

H=850 mm



CONFIGURE

ARMADIO CON 6 CASSETTI 1X50 2X100 2X150 1X200



ART.	cassetti		RAL	€
M23A085C01091PD	100-75-50	92-96-100%	7035+7016	834,60
M23A085C0109108	100-75-50	92-96-100%	7035	780,00
M23A085C0109104	100-75-50	92-96-100%	5012	780,00

H=850 mm

PE: PIANO ESTRAIBILE
PR: PIANO REGOLABILE



DIM. INTERNE LxP



PORTATA



ESTRAZIONE



RAL 7035 + RAL 7016



RAL 5012



RAL 7035



CONFIGURE

ARMADIO CON 7 CASSETTI 1X50 2X75 2X100 1X150 1X200

ART.	cassetti		RAL	€
M23A085C010AEPD	100-75-50	92-96-100%	7035+7016	905,70
M23A085C010AE08	100-75-50	92-96-100%	7035	838,20
M23A085C010AE04	100-75-50	92-96-100%	5012	838,20

H=850 mm



CONFIGURE

ARMADIO CON 7 CASSETTI 2X75 3X100 2X150

ART.	cassetti		RAL	€
M23A085C01095PD	100-75-50	92-96-100%	7035+7016	906,60
M23A085C0109508	100-75-50	92-96-100%	7035	836,40
M23A085C0109504	100-75-50	92-96-100%	5012	836,40

H=850 mm



CONFIGURE

ARMADIO CON 8 CASSETTI 1X50 2X75 4X100 1X150

ART.	cassetti		RAL	€
M23A085C01087PD	100-75-50	92-96-100%	7035+7016	985,20
M23A085C0108708	100-75-50	92-96-100%	7035	900,00
M23A085C0108704	100-75-50	92-96-100%	5012	900,00

H=850 mm



CONFIGURE

ARMADIO CON RUOTE CON 4 CASSETTI 2X75 1X150 1X200

ART.	cassetti		RAL	€
M23R060C01020PD	100-75-50	92-96-100%	7035+7016	809,70
M23R060C0102008	100-75-50	92-96-100%	7035	776,10
M23R060C0102004	100-75-50	92-96-100%	5012	776,10

H=822 mm

Ruote: Gomma standard Ø 125 mm
Portata armadio: 300 kg



CONFIGURE

ARMADIO CON RUOTE CON 5 CASSETTI 1X50 2X75 1X100 1X200

ART.	cassetti		RAL	€
M23R060C01021PD	100-75-50	92-96-100%	7035+7016	888,00
M23R060C0102108	100-75-50	92-96-100%	7035	840,00
M23R060C0102104	100-75-50	92-96-100%	5012	840,00

H=822 mm

Ruote: Gomma standard Ø 125 mm
Portata armadio: 300 kg



CONFIGURE

ARMADIO CON RUOTE CON 6 CASSETTI 4X75 2X100



ART.	cassetti		RAL	€
M23R060C01022PD	100-75-50	92-96-100%	7035+7016	960,00
M23R060C0102208	100-75-50	92-96-100%	7035	896,40
M23R060C0102204	100-75-50	92-96-100%	5012	896,40

H=822 mm

Ruote: Gomma standard Ø 125 mm
Portata armadio: 300 kg



CONFIGURE

ARMADIO CON RUOTE CON 5 CASSETTI 2X75 1X100 1X150 1X200



ART.	cassetti		RAL	€
M23R070C01031PD	100-75-50	92-96-100%	7035+7016	905,40
M23R070C0103108	100-75-50	92-96-100%	7035	861,30
M23R070C0103104	100-75-50	92-96-100%	5012	861,30

H=922 mm

Ruote: Gomma standard Ø 125 mm
Portata armadio: 300 kg



CONFIGURE

ARMADIO CON RUOTE CON 6 CASSETTI 1X50 2X75 2X100 1X200



ART.	cassetti		RAL	€
M23R070C01032PD	100-75-50	92-96-100%	7035+7016	984,00
M23R070C0103208	100-75-50	92-96-100%	7035	924,90
M23R070C0103204	100-75-50	92-96-100%	5012	924,90

H=922 mm

Ruote: Gomma standard Ø 125 mm
Portata armadio: 300 kg



CONFIGURE

ARMADIO CON RUOTE CON 5 CASSETTI 1X50 2X100 1X150 1X300



ART.	cassetti		RAL	€
M23R080C01054PD	100-75-50	92-96-100%	7035+7016	924,90
M23R080C0105408	100-75-50	92-96-100%	7035	875,10
M23R080C0105404	100-75-50	92-96-100%	5012	875,10

H=1022 mm

Ruote: Gomma standard Ø 125 mm
Portata armadio: 300 kg



CONFIGURE

ARMADIO CON RUOTE CON 5 CASSETTI 3X100 2X200



ART.	cassetti		RAL	€
M23R080C01063PD	100-75-50	92-96-100%	7035+7016	927,90
M23R080C0106308	100-75-50	92-96-100%	7035	887,40
M23R080C0106304	100-75-50	92-96-100%	5012	887,40

H=1022 mm

Ruote: Gomma standard Ø 125 mm
Portata armadio: 300 kg



DIM. INTERNE LxP



PORTATA



ESTRAZIONE



RAL 7035 + RAL 7016



RAL 5012



RAL 7035



[CONFIGURE](#)

ARMADIO CON RUOTE CON 7 CASSETTI 2X75 4X100 1X150

ART.	cassetti		RAL	€
M23R080C01065PD	100-75-50	92-96-100%	7035+7016	1072,80
M23R080C0106508	100-75-50	92-96-100%	7035	1000,20
M23R080C0106504	100-75-50	92-96-100%	5012	1000,20

H=1022 mm

Ruote: Gomma standard Ø 125 mm
Portata armadio: 300 kg



[CONFIGURE](#)

ARMADIO CON RUOTE CON 7 CASSETTI 1X50 2X75 2X100 2X150

ART.	cassetti		RAL	€
M23R080C01066PD	100-75-50	92-96-100%	7035+7016	1066,50
M23R080C0106608	100-75-50	92-96-100%	7035	994,80
M23R080C0106604	100-75-50	92-96-100%	5012	994,80

H=1022 mm

Ruote: Gomma standard Ø 125 mm
Portata armadio: 300 kg





Utensili e termoformati esclusi



CASSETTO H 50 mm

Set composto da 12 divisori a 4 canali e 65 divisori trasversali 36 mm



CASSETTO H 75 mm

Set di predisposizione per termoformati



CASSETTO H 150 mm

Set composto da 2 divisori longitudinali fessurati 610 mm e 3 divisori trasversali 149 mm



DIM. INTERNE LxP



PORTATA



ESTRAZIONE



RAL 7035 + RAL 7016



RAL 5012



RAL 7035



MATERIALE DI SEPARAZIONE



ART.	adatto per cassetto H mm	componenti	€
FFH86050100	50/300	50 x Divisorio trasversale L=36 mm 12 x Divisorio a 4 canali	26,70



ART.	adatto per cassetto H mm	componenti	€
FFH86050200	50/300	4 x Divisorio a 4 canali 8 x Divisorio a 3 canali 20 x Divisorio trasversale L=36 mm 10 x Divisorio trasversale L=47 mm	32,70



ART.	adatto per cassetto H mm	componenti	€
FFH86050300	50/300	4 x Divisorio a 3 canali 8 x Divisorio a 2 canali 20 x Divisorio trasversale L=47 mm 10 x Divisorio trasversale L=73 mm	31,50



ART.	adatto per cassetto H mm	componenti	€
FFH86051600	50	16 x Cassetta divisorio con divisorio fisso 75x75 mm	24,30



FFH86071600	75	16 x Cassetta divisorio 75x75 mm 4 x Cassetta divisorio 150x75 mm 2 x Cassetta divisorio 150x150 mm	28,20
-------------	----	---	-------



ART.	adatto per cassetto H mm	componenti	€
FFH86051700	50	16 x Cassetta divisorio 75x75 mm 8 x Cassetta divisorio 150x75 mm	22,50



FFH86071700	75	4 x Cassetta divisorio 150x150 mm	28,20
-------------	----	-----------------------------------	-------



ART.	adatto per cassetto H mm	componenti	€
FFH86051800	50	12 x Cassetta divisorio 150x75 mm 6 x Cassetta divisorio 150x150 mm	19,80



FFH86071800	75		25,20
-------------	----	--	-------



FFH86101800	100/125		29,10
-------------	---------	--	-------



MATERIALE DI SEPARAZIONE



ART.	adatto per cassetto H mm	componenti	€
FFH86050700	50	1 x Divisorio longitudinale fessurato L=610 mm 1 x Divisorio trasversale L=202 mm 1 x Divisorio trasversale L=253 mm	6,60
FFH86070700	75		5,70
FFH86100700	100/125		6,90
FFH86150700	150/175		9,90
FFH86200700	200/250		15,60
FFH86300700	300		34,50



ART.	adatto per cassetto H mm	componenti	€
FFH86050800	50	2 x Divisorio longitudinale fessurato L=610 mm 3 x Divisorio trasversale L=151 mm	9,90
FFH86070800	75		8,40
FFH86100800	100/125		10,50
FFH86150800	150/175		15,00
FFH86200800	200/250		23,10
FFH86300800	300		52,50



ART.	adatto per cassetto H mm	componenti	€
FFH86050900	50	2 x Divisorio longitudinale fessurato L=610 mm 10 x Divisorio trasversale L=151 mm	14,40
FFH86070900	75		12,90
FFH86100900	100/125		16,20
FFH86150900	150/175		23,10
FFH86200900	200/250		34,80



ART.	adatto per cassetto H mm	componenti	€
FFH86051000	50	3 x Divisorio longitudinale fessurato L=610 mm 6 x Divisorio trasversale L=100 mm 2 x Divisorio trasversale L=151 mm	16,80
FFH86071000	75		14,10
FFH86101000	100/125		18,00
FFH86151000	150/175		25,50



ART.	adatto per cassetto H mm	componenti	€
FFH86051300	50	2 x Divisorio longitudinale non fessurato L=610 mm	9,90
FFH86071300	75		8,70
FFH86101300	100/125		9,90
FFH86151300	150/175		12,60
FFH86201300	200/250		15,90
FFH86301300	300		20,40

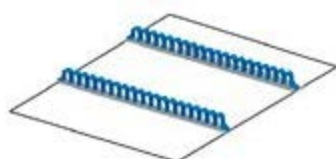

ART.	adatto per cassetto H mm	componenti	€
FFH86051900	50/300	2 x Portautensili multiuso	19,20



ARMADIO CON 4 CASSETTI 1X100 2X150 1X300



ART.	cassetti		RAL	€
	KG			
M33A080C01072PD	100-75-50	92-96-100%	7035+7016	791,40
M33A080C0107208	100-75-50	92-96-100%	7035	746,10
M33A080C0107204	100-75-50	92-96-100%	5012	746,10

H=800 mm

CONFIGURE

ARMADIO CON 6 CASSETTI 2X75 2X100 1X150 1X200



ART.	cassetti		RAL	€
	KG			
M33A080C01056PD	100-75-50	92-96-100%	7035+7016	963,60
M33A080C0105608	100-75-50	92-96-100%	7035	892,50
M33A080C0105604	100-75-50	92-96-100%	5012	892,50

H=800 mm

CONFIGURE

ARMADIO CON 4 CASSETTI 1X100 1X150 1X200 1X300



ART.	cassetti		RAL	€
	KG			
M33A085C01092PD	100-75-50	92-96-100%	7035+7016	763,80
M33A085C0109208	100-75-50	92-96-100%	7035	714,90
M33A085C0109204	100-75-50	92-96-100%	5012	714,90
M33A085C010ASPD	200	100%	7035+7016	887,40
M33A085C010AS08	200	100%	7035	838,50
M33A085C010AS04	200	100%	5012	838,50

H=850 mm

CONFIGURE

ARMADIO CON 5 CASSETTI 1X50 2X100 1X200 1X300



ART.	cassetti		RAL	€
	KG			
M33A085C01093PD	100-75-50	92-96-100%	7035+7016	852,60
M33A085C0109308	100-75-50	92-96-100%	7035	787,20
M33A085C0109304	100-75-50	92-96-100%	5012	787,20
M33A085C010ATPD	200	100%	7035+7016	976,20
M33A085C010AT08	200	100%	7035	910,80
M33A085C010AT04	200	100%	5012	910,80

H=850 mm I cassetti H=50 mm hanno sempre estrazione flessibile

CONFIGURE



ARMADIO CON 5 CASSETTI 1X100 3X150 1X200



ART.	cassetti		RAL	€
	KG			
M33A085C01088PD	100-75-50	92-96-100%	7035+7016	842,70
M33A085C0108808	100-75-50	92-96-100%	7035	788,70
M33A085C0108804	100-75-50	92-96-100%	5012	788,70
M33A085C010APPD	200	100%	7035+7016	997,20
M33A085C010AP08	200	100%	7035	943,20
M33A085C010AP04	200	100%	5012	943,20

CONFIGURE

H=850 mm



ARMADIO CON 7 CASSETTI 1X50 2X75 2X100 1X150 1X200

ART.	cassetti		RAL	€
	KG			
M33A085C010AEPD	100-75-50	92-96-100%	7035+7016	1017,60
M33A085C010AE08	100-75-50	92-96-100%	7035	932,70
M33A085C010AE04	100-75-50	92-96-100%	5012	932,70
M33A085C010AFPD	200	100%	7035+7016	1203,00
M33A085C010AF08	200	100%	7035	1118,10
M33A085C010AF04	200	100%	5012	1118,10

CONFIGURE

H=850 mm I cassetti H=50 mm hanno sempre estrazione flessibile



ARMADIO CON 7 CASSETTI 2X75 3X100 2X150

ART.	cassetti		RAL	€
	KG			
M33A085C01095PD	100-75-50	92-96-100%	7035+7016	1010,40
M33A085C0109508	100-75-50	92-96-100%	7035	930,90
M33A085C0109504	100-75-50	92-96-100%	5012	930,90
M33A085C010AUPD	200	100%	7035+7016	1226,70
M33A085C010AU08	200	100%	7035	1147,20
M33A085C010AU04	200	100%	5012	1147,20

CONFIGURE

H=850 mm



ARMADIO CON 8 CASSETTI 1X50 2X75 4X100 1X150

ART.	cassetti		RAL	€
	KG			
M33A085C01087PD	100-75-50	92-96-100%	7035+7016	1099,20
M33A085C0108708	100-75-50	92-96-100%	7035	1003,20
M33A085C0108704	100-75-50	92-96-100%	5012	1003,20
M33A085C010AVPD	200	100%	7035+7016	1315,50
M33A085C010AV08	200	100%	7035	1219,50
M33A085C010AV04	200	100%	5012	1219,50

CONFIGURE

H=850 mm I cassetti H=50 mm hanno sempre estrazione flessibile



DIM. INTERNE LxP



PORTATA



ESTRAZIONE



RAL 7035 + RAL 7016



RAL 5012



RAL 7035



ARMADIO CON 6 CASSETTI 1X50 3X150 2X200

ART.	cassetti		RAL	€
M33A100C010CZPD	100-75-50	92-96-100%	7035+7016	996,30
M33A100C010CZ08	100-75-50	92-96-100%	7035	927,00
M33A100C010CZ04	100-75-50	92-96-100%	5012	927,00
M33A100C010DAPD	200	100%	7035+7016	1150,80
M33A100C010DA08	200	100%	7035	1081,50
M33A100C010DA04	200	100%	5012	1081,50

CONFIGURE

H=1000 mm I cassetti H=50 mm hanno sempre estrazione flessibile



ARMADIO CON 6 CASSETTI 1X100 4X150 1X200

ART.	cassetti		RAL	€
M33A100C010DBPD	100-75-50	92-96-100%	7035+7016	989,10
M33A100C010DB08	100-75-50	92-96-100%	7035	925,50
M33A100C010DB04	100-75-50	92-96-100%	5012	925,50
M33A100C010DCPD	200	100%	7035+7016	1174,50
M33A100C010DC08	200	100%	7035	1110,90
M33A100C010DC04	200	100%	5012	1110,90

CONFIGURE

H=1000 mm



ARMADIO CON 7 CASSETTI 1X50 2X75 2X100 1X200 1X300

ART.	cassetti		RAL	€
M33A100C010BNPD	100-75-50	92-96-100%	7035+7016	1085,10
M33A100C010BN08	100-75-50	92-96-100%	7035	996,00
M33A100C010BN04	100-75-50	92-96-100%	5012	996,00
M33A100C010BPPD	200	100%	7035+7016	1270,50
M33A100C010BP08	200	100%	7035	1181,40
M33A100C010BP04	200	100%	5012	1181,40

CONFIGURE

H=1000 mm I cassetti H=50 mm hanno sempre estrazione flessibile



ARMADIO CON 7 CASSETTI 2X75 1X100 3X150 1X200

ART.	cassetti		RAL	€
M33A100C010AWPD	100-75-50	92-96-100%	7035+7016	1075,20
M33A100C010AW08	100-75-50	92-96-100%	7035	997,20
M33A100C010AW04	100-75-50	92-96-100%	5012	997,20
M33A100C010BHPD	200	100%	7035+7016	1291,50
M33A100C010BH08	200	100%	7035	1213,50
M33A100C010BH04	200	100%	5012	1213,50

CONFIGURE

H=1000 mm



ARMADIO CON 8 CASSETTI 1X50 2X75 2X100 2X150 1X200

ART.	cassetti		RAL	€
M33A100C010CUPD	100-75-50	92-96-100%	7035+7016	1164,00
M33A100C010CU08	100-75-50	92-96-100%	7035	1069,50
M33A100C010CU04	100-75-50	92-96-100%	5012	1069,50
M33A100C010CVPD	200	100%	7035+7016	1380,30
M33A100C010CV08	200	100%	7035	1285,80
M33A100C010CV04	200	100%	5012	1285,80

CONFIGURE

H=1000 mm I cassetti H=50 mm hanno sempre estrazione flessibile



ARMADIO CON 8 CASSETTI 2X75 3X100 3X150

ART.	cassetti		RAL	€
M33A100C010DDPD	100-75-50	92-96-100%	7035+7016	1156,80
M33A100C010DD08	100-75-50	92-96-100%	7035	1068,00
M33A100C010DD04	100-75-50	92-96-100%	5012	1068,00
M33A100C010DEPD	200	100%	7035+7016	1404,00
M33A100C010DE08	200	100%	7035	1315,20
M33A100C010DE04	200	100%	5012	1315,20

CONFIGURE

H=1000 mm



ARMADIO CON 9 CASSETTI 9X100

ART.	cassetti		RAL	€
M33A100C010BLPD	100-75-50	92-96-100%	7035+7016	1248,00
M33A100C010BL08	100-75-50	92-96-100%	7035	1139,70
M33A100C010BL04	100-75-50	92-96-100%	5012	1139,70
M33A100C010BMPD	200	100%	7035+7016	1526,10
M33A100C010BM08	200	100%	7035	1417,80
M33A100C010BM04	200	100%	5012	1417,80

CONFIGURE

H=1000 mm



ARMADIO CON 10 CASSETTI 1X50 2X75 7X100

ART.	cassetti		RAL	€
M33A100C010DFPD	100-75-50	92-96-100%	7035+7016	1334,40
M33A100C010DF08	100-75-50	92-96-100%	7035	1212,00
M33A100C010DF04	100-75-50	92-96-100%	5012	1212,00
M33A100C010DGPD	200	100%	7035+7016	1612,50
M33A100C010DG08	200	100%	7035	1490,10
M33A100C010DG04	200	100%	5012	1490,10

CONFIGURE

H=1000 mm I cassetti H=50 mm hanno sempre estrazione flessibile





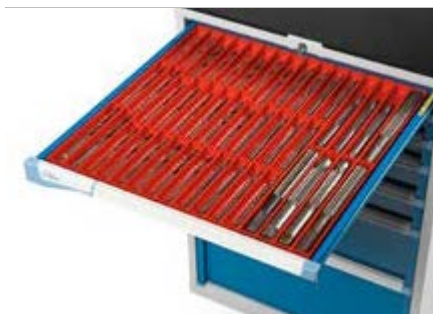

CASSETTO H 50 mm

Set composto da 16 divisori a 4 canali e 65 divisori trasversali 36 mm



CASSETTO H 75 mm

Set di predisposizione per termoformati



CASSETTO H 75 mm

Set di predisposizione per termoformati



CASSETTO H 100 mm

Set di predisposizione per termoformati



CASSETTO H 100 mm

Set composto da 3 divisori longitudinali fessurati 610 mm e 15 divisori trasversali 149 mm



CASSETTO H 200 mm

Set composto da 2 divisori longitudinali fessurati 610 mm e 3 divisori trasversali 200 mm



CASSETTO H 300 mm

Set composto da 1 divisorio longitudinale fessurato 610 mm



Utensili e termoformati esclusi

Disponibili in varie dimensioni



ARMADIO CON PORTE CON 2 CASSETTI 2X75 2XPE

ART.	cassetti / piani estraibili		RAL	€
M33A100C010LJPD	100-75-50	92-96-100%	7035+7016	950,10
M33A100C010LJ08	100-75-50	92-96-100%	7035	950,10
M33A100C010LJ04	100-75-50	92-96-100%	5012	950,10
M33A100C010LKPD	200	100%	7035+7016	1073,70
M33A100C010LK08	200	100%	7035	1073,70
M33A100C010LK04	200	100%	5012	1073,70

CONFIGURE

H=1022 mm



ARMADIO CON PORTE 2XPR 2XPE

ART.	piani estraibili		RAL	€
M33A100C010LMPD	100-75-50	92-96-100%	7035+7016	905,70
M33A100C010LM08	100-75-50	92-96-100%	7035	905,70
M33A100C010LM04	100-75-50	92-96-100%	5012	905,70
M33A100C010LNPD	200	100%	7035+7016	967,50
M33A100C010LN08	200	100%	7035	967,50
M33A100C010LN04	200	100%	5012	967,50

CONFIGURE

H=1022 mm



ARMADIO CON PORTE CON 4 CASSETTI 4X75

ART.	cassetti		RAL	€
M33A100C010CCPD	100-75-50	92-96-100%	7035+7016	915,60
M33A100C010CC08	100-75-50	92-96-100%	7035	915,60
M33A100C010CC04	100-75-50	92-96-100%	5012	915,60
M33A100C010CDPD	200	100%	7035+7016	1039,20
M33A100C010CD08	200	100%	7035	1039,20
M33A100C010CD04	200	100%	5012	1039,20

CONFIGURE

H=1022 mm



ARMADIO CON PORTE CON 3 CASSETTI 1X125 2X75 2XPE

ART.	cassetti / piani estraibili		RAL	€
M33A100C010LRPD	100-75-50	92-96-100%	7035+7016	1088,70
M33A100C010LR08	100-75-50	92-96-100%	7035	1076,70
M33A100C010LR04	100-75-50	92-96-100%	5012	1076,70
M33A100C010LSPD	200	100%	7035+7016	1243,20
M33A100C010LS08	200	100%	7035	1231,20
M33A100C010LS04	200	100%	5012	1231,20

CONFIGURE

H=1022 mm



ARMADIO CON PORTE CON 5 CASSETTI 1X50 2X75 2X100 1XPE



ART.	cassetti / piani estraibili		RAL	€
	KG			
M33A100C010LTPD	100-75-50	92-96-100%	7035+7016	1165,50
M33A100C010LT08	100-75-50	92-96-100%	7035	1139,70
M33A100C010LT04	100-75-50	92-96-100%	5012	1139,70
M33A100C010LUPD	200	100%	7035+7016	1320,00
M33A100C010LU08	200	100%	7035	1294,20
M33A100C010LU04	200	100%	5012	1294,20

CONFIGURE

H=1022 mm I cassetti H=50 mm hanno sempre estrazione flessibile



ARMADIO CON PORTE CON 5 CASSETTI 1X50 4X75 1XPE

ART.	cassetti / piani estraibili		RAL	€
	KG			
M33A100C010LVPD	100-75-50	92-96-100%	7035+7016	1158,00
M33A100C010LV08	100-75-50	92-96-100%	7035	1132,20
M33A100C010LV04	100-75-50	92-96-100%	5012	1132,20
M33A100C010LWPD	200	100%	7035+7016	1312,50
M33A100C010LW08	200	100%	7035	1286,70
M33A100C010LW04	200	100%	5012	1286,70

CONFIGURE

H=1022 mm I cassetti H=50 mm hanno sempre estrazione flessibile



ARMADIO CON PORTE SCORREVOLI CON 4 CASSETTI 4X75 2XPE

ART.	cassetti / piani estraibili		RAL	€
	KG			
M33D100C010GYPD	100-75-50	92-96-100%	7035+7016	1823,40
M33D100C010GY08	100-75-50	92-96-100%	7035	1823,40
M33D100C010GY04	100-75-50	92-96-100%	5012	1823,40
M33D100C010GZPD	200	100%	7035+7016	2008,80
M33D100C010GZ08	200	100%	7035	2008,80
M33D100C010GZ04	200	100%	5012	2008,80

CONFIGURE

H=1022 mm



ARMADIO CON PORTE SCORREVOLI 4XPR 2XPE

ART.	piani estraibili		RAL	€
	KG			
M33D100C010JAPD	100-75-50	92-96-100%	7035+7016	1648,50
M33D100C010JA08	100-75-50	92-96-100%	7035	1648,50
M33D100C010JA04	100-75-50	92-96-100%	5012	1648,50
M33D100C010JBPD	200	100%	7035+7016	1710,30
M33D100C010JB08	200	100%	7035	1710,30
M33D100C010JB04	200	100%	5012	1710,30

CONFIGURE

H=1022 mm

PE: PIANO ESTRAIBILE
PR: PIANO REGOLABILE



DIM. INTERNE LxP



PORTATA



ESTRAZIONE



RAL 7035 + RAL 7016



RAL 5012



RAL 7035



ARMADIO CON PORTE SCORREVOLI CON 4 CASSETTI 4X75 4XPE



ART.	cassetti / piani estraibili		RAL	€
M33D100C010HEPD	100-75-50	92-96-100%	7035+7016	2023,50
M33D100C010HE08	100-75-50	92-96-100%	7035	2023,50
M33D100C010HE04	100-75-50	92-96-100%	5012	2023,50
M33D100C010HFPD	200	100%	7035+7016	2270,70
M33D100C010HF08	200	100%	7035	2270,70
M33D100C010HF04	200	100%	5012	2270,70

CONFIGURE

H=1022 mm

ARMADIO CON 9 CASSETTI 2X75 2X100 1X150 3X200 1X300



ART.	cassetti		RAL	€
M33A150C010LXPD	100-75-50	92-96-100%	7035+7016	1408,20
M33A150C010LX08	100-75-50	92-96-100%	7035	1296,60
M33A150C010LX04	100-75-50	92-96-100%	5012	1296,60
M33A150C010LYPD	200	100%	7035+7016	1686,30
M33A150C010LY08	200	100%	7035	1574,70
M33A150C010LY04	200	100%	5012	1574,70

CONFIGURE

H=1500 mm

ARMADIO CON 9 CASSETTI 2X100 6X150 1X300



ART.	cassetti		RAL	€
M33A150C010FJPD	100-75-50	92-96-100%	7035+7016	1389,30
M33A150C010FJ08	100-75-50	92-96-100%	7035	1293,90
M33A150C010FJ04	100-75-50	92-96-100%	5012	1293,90
M33A150C010FKPD	200	100%	7035+7016	1667,40
M33A150C010FK08	200	100%	7035	1572,00
M33A150C010FK04	200	100%	5012	1572,00

CONFIGURE

H=1500 mm

ARMADIO CON 10 CASSETTI 1X50 4X100 1X150 4X200



ART.	cassetti		RAL	€
M33A150C010LZPD	100-75-50	92-96-100%	7035+7016	1496,40
M33A150C010LZ08	100-75-50	92-96-100%	7035	1371,60
M33A150C010LZ04	100-75-50	92-96-100%	5012	1371,60
M33A150C010MAPD	200	100%	7035+7016	1774,50
M33A150C010MA08	200	100%	7035	1649,70
M33A150C010MA04	200	100%	5012	1649,70

CONFIGURE

H=1500 mm I cassetti H=50 mm hanno sempre estrazione flessibile



ARMADIO CON PORTE CON 3 CASSETTI 2X75 1X150 2XPE



ART.	cassetti / piani estraibili		RAL	€
M33A150C010LAPD	100-75-50	92-96-100%	7035+7016	1080,90
M33A150C010LA08	100-75-50	92-96-100%	7035	1080,90
M33A150C010LA04	100-75-50	92-96-100%	5012	1080,90
M33A150C010LBDP	200	100%	7035+7016	1235,40
M33A150C010LB08	200	100%	7035	1235,40
M33A150C010LB04	200	100%	5012	1235,40

CONFIGURE

H=1500 mm



ARMADIO CON PORTE 3XPR 2XPE

ART.	piani estraibili		RAL	€
M33A150C010LCPD	100-75-50	92-96-100%	7035+7016	1002,90
M33A150C010LC08	100-75-50	92-96-100%	7035	1002,90
M33A150C010LC04	100-75-50	92-96-100%	5012	1002,90
M33A150C010LDPD	200	100%	7035+7016	1064,70
M33A150C010LD08	200	100%	7035	1064,70
M33A150C010LD04	200	100%	5012	1064,70

CONFIGURE

H=1500 mm



ARMADIO CON PORTE CON 5 CASSETTI 2X75 3X150

ART.	cassetti		RAL	€
M33A150C010LEPD	100-75-50	92-96-100%	7035+7016	1068,60
M33A150C010LE08	100-75-50	92-96-100%	7035	1068,60
M33A150C010LE04	100-75-50	92-96-100%	5012	1068,60
M33A150C010LFPD	200	100%	7035+7016	1223,10
M33A150C010LF08	200	100%	7035	1223,10
M33A150C010LF04	200	100%	5012	1223,10

CONFIGURE

H=1500 mm



PE: PIANO ESTRAIBILE
PR: PIANO REGOLABILE



DIM. INTERNE LxP



PORTATA



ESTRAZIONE



RAL 7035 + RAL 7016



RAL 5012



RAL 7035



ARMADIO CON 7 CASSETTI 2XPR 2X75 1X100 3X150 1X200

ART.	cassetti		RAL	€
M33A200C010FSPD	100-75-50	92-96-100%	7035+7016	1463,10
M33A200C010FS08	100-75-50	92-96-100%	7035	1384,80
M33A200C010FS04	100-75-50	92-96-100%	5012	1384,80
M33A200C010FTPD	200	100%	7035+7016	1679,40
M33A200C010FT08	200	100%	7035	1601,10
M33A200C010FT04	200	100%	5012	1601,10

H=2000 mm

CONFIGURE



ARMADIO CON PORTE CON 3 CASSETTI 2XPR 2X100 1X150 2XPE

ART.	cassetti / piani estraibili		RAL	€
M33A200C010FWPD	100-75-50	92-96-100%	7035+7016	1420,80
M33A200C010FW08	100-75-50	92-96-100%	7035	1420,80
M33A200C010FW04	100-75-50	92-96-100%	5012	1420,80
M33A200C010FXPD	200	100%	7035+7016	1575,30
M33A200C010FX08	200	100%	7035	1575,30
M33A200C010FX04	200	100%	5012	1575,30

H=2000 mm

CONFIGURE



ARMADIO CON PORTE CON 7 CASSETTI 3XPR 2X75 1X100 3X150 1X200

ART.	cassetti		RAL	€
M33A200C010FYPD	100-75-50	92-96-100%	7035+7016	1771,20
M33A200C010FY08	100-75-50	92-96-100%	7035	1692,90
M33A200C010FY04	100-75-50	92-96-100%	5012	1692,90
M33A200C010FZPD	200	100%	7035+7016	1987,50
M33A200C010FZ08	200	100%	7035	1909,20
M33A200C010FZ04	200	100%	5012	1909,20

H=2000 mm

CONFIGURE



CONFIGURE

ARMADIO CON RUOTE CON 3 CASSETTI 1X100 1X200 1X300

ART.	cassetti		RAL	€
M33R070C01029PD	100-75-50	92-96-100%	7035+7016	926,40
M33R070C0102908	100-75-50	92-96-100%	7035	887,10
M33R070C0102904	100-75-50	92-96-100%	5012	887,10

H=922 mm Ruote: Gomma elastica Ø 125 mm
Portata armadio: 750 kg



CONFIGURE

ARMADIO CON RUOTE CON 5 CASSETTI 1X50 2X100 1X150 1X200

ART.	cassetti		RAL	€
M33R070C01040PD	100-75-50	92-96-100%	7035+7016	1093,80
M33R070C0104008	100-75-50	92-96-100%	7035	1032,90
M33R070C0104004	100-75-50	92-96-100%	5012	1032,90

H=922 mm Ruote: Gomma elastica Ø 125 mm
Portata armadio: 750 kg



CONFIGURE

ARMADIO CON RUOTE CON 6 CASSETTI 2X75 3X100 1X150

ART.	cassetti		RAL	€
M33R070C01044PD	100-75-50	92-96-100%	7035+7016	1173,00
M33R070C0104408	100-75-50	92-96-100%	7035	1103,10
M33R070C0104404	100-75-50	92-96-100%	5012	1103,10

H=922 mm Ruote: Gomma elastica Ø 125 mm
Portata armadio: 750 kg



CONFIGURE

ARMADIO CON RUOTE CON 7 CASSETTI 2X75 2X100 2X125 1X150

ART.	cassetti		RAL	€
M33R085C010ACPD	100-75-50	92-96-100%	7035+7016	1296,60
M33R085C010AC08	100-75-50	92-96-100%	7035	1214,70
M33R085C010AC04	100-75-50	92-96-100%	5012	1214,70

H=1072 mm Ruote: Gomma elastica Ø 125 mm
Portata armadio: 750 kg



CONFIGURE

ARMADIO CON RUOTE CON 8 CASSETTI 4X75 3X100 1X150

ART.	cassetti		RAL	€
M33R085C010AGPD	100-75-50	92-96-100%	7035+7016	1381,50
M33R085C010AG08	100-75-50	92-96-100%	7035	1287,60
M33R085C010AG04	100-75-50	92-96-100%	5012	1287,60

H=1072 mm Ruote: Gomma elastica Ø 125 mm
Portata armadio: 750 kg





MATERIALE DI SEPARAZIONE



ART.	adatto per cassetto H mm	componenti	€
FFH20051500	50/300	35 x Divisorio trasversale L=73 mm 16 x Divisorio a 2 canali	34,20



ART.	adatto per cassetto H mm	componenti	€
FFH20051600	50/300	50 x Divisorio trasversale L=47 mm 16 x Divisorio a 3 canali	36,60



ART.	adatto per cassetto H mm	componenti	€
FFH20051700	50/300	65 x Divisorio trasversale L=36 mm 16 x Divisorio a 4 canali	39,90



ART.	adatto per cassetto H mm	componenti	€
FFH20052000	50/300	30 x Divisorio trasversale L=36 mm 20 x Divisorio trasversale L=47 mm 10 x Divisorio trasversale L=73 mm 4 x Divisorio a 2 canali 8 x Divisorio a 3 canali 4 x Divisorio a 4 canali	32,70



ART.	adatto per cassetto H mm	componenti	€
FFH20052100	50/300	8 x Divisorio a 3 canali 8 x Divisorio a 4 canali 16 x Divisorio trasversale L=47 mm 24 x Divisorio trasversale L=36 mm	44,40



ART.	adatto per cassetto H mm	componenti	€
FFH20051200	50	16 x Cassetta divisorio 75x75 mm 16 x Cassetta divisorio 150x75 mm	31,50
FFH20071200	75	4 x Cassetta divisorio 150x150 mm	41,70





MATERIALE DI SEPARAZIONE



ART.	adatto per cassetto H mm	componenti	€
FFH20051300	50	16 x Cassetta divisorio 150x75 mm 8 x Cassetta divisorio 150x150 mm	27,60
FFH20071300	75		37,80
FFH20101300	100/125		44,10



ART.	adatto per cassetto H mm	componenti	€
FFH20050500	50	1 x Divisorio longitudinale fessurato L=610 mm 2 x Divisorio trasversale L=304 mm	9,90
FFH20070500	75		9,90
FFH20100500	100/125		10,80
FFH20150500	150/175		13,50
FFH20200500	200/250		20,10
FFH20300500	300		33,00



ART.	adatto per cassetto H mm	componenti	€
FFH20050600	50	2 x Divisorio longitudinale fessurato L=610 mm 3 x Divisorio trasversale L=202 mm	15,00
FFH20070600	75		15,00
FFH20100600	100/125		17,10
FFH20150600	150/175		23,10
FFH20200600	200/250		35,10
FFH20300600	300		61,80



ART.	adatto per cassetto H mm	componenti	€
FFH20050700	50	3 x Divisorio longitudinale fessurato L=610 mm 15 x Divisorio trasversale L=151 mm	23,10
FFH20070700	75		23,10
FFH20100700	100/125		24,00
FFH20150700	150/175		34,20
FFH20200700	200/250		52,20



ART.	adatto per cassetto H mm	componenti	€
FFH20050800	50	4 x Divisorio longitudinale fessurato L=610 mm 9 x Divisorio trasversale L=151 mm 12 x Divisorio trasversale L=100 mm	30,30
FFH20070800	75		29,40
FFH20100800	100/125		39,60



ART.	adatto per cassetto H mm	componenti	€
FFH20050900	50	5 x Divisorio longitudinale fessurato L=610 mm 20 x Divisorio trasversale L=100 mm	33,90
FFH20070900	75		29,40
FFH20100900	100/125		40,20
FFH20150900	150/175		55,50



ARMADIO CON 7 CASSETTI 1X50 2X75 2X100 1X150 1X200



ART.	cassetti		RAL	€
M43A085C010AEPD	100-75-50	92-96-100%	7035+7016	1287,00
M43A085C010AE08	100-75-50	92-96-100%	7035	1182,00
M43A085C010AE04	100-75-50	92-96-100%	5012	1182,00
M43A085C010AFPD	200	100%	7035+7016	1472,40
M43A085C010AF08	200	100%	7035	1367,40
M43A085C010AF04	200	100%	5012	1367,40

CONFIGURE

H=850 mm I cassetti H=50 mm hanno sempre estrazione flessibile

ARMADIO CON 7 CASSETTI 2X75 2X100 2X125 1X150



ART.	cassetti		RAL	€
M43A085C010ACPD	100-75-50	92-96-100%	7035+7016	1271,10
M43A085C010AC08	100-75-50	92-96-100%	7035	1175,40
M43A085C010AC04	100-75-50	92-96-100%	5012	1175,40
M43A085C010ADPD	200	100%	7035+7016	1487,40
M43A085C010AD08	200	100%	7035	1391,70
M43A085C010AD04	200	100%	5012	1391,70

CONFIGURE

H=850 mm

ARMADIO CON 8 CASSETTI 4X75 3X100 1X150



ART.	cassetti		RAL	€
M43A085C010AGPD	100-75-50	92-96-100%	7035+7016	1378,50
M43A085C010AG08	100-75-50	92-96-100%	7035	1264,20
M43A085C010AG04	100-75-50	92-96-100%	5012	1264,20
M43A085C010AHPD	200	100%	7035+7016	1625,70
M43A085C010AH08	200	100%	7035	1511,40
M43A085C010AH04	200	100%	5012	1511,40

CONFIGURE

H=850 mm

ARMADIO CON 7 CASSETTI 1X50 2X75 2X100 1X200 1X300



ART.	cassetti		RAL	€
M43A100C010BNPD	100-75-50	92-96-100%	7035+7016	1333,50
M43A100C010BN08	100-75-50	92-96-100%	7035	1224,30
M43A100C010BN04	100-75-50	92-96-100%	5012	1224,30
M43A100C010BPPD	200	100%	7035+7016	1518,90
M43A100C010BP08	200	100%	7035	1409,70
M43A100C010BP04	200	100%	5012	1409,70

CONFIGURE

H=1000 mm I cassetti H=50 mm hanno sempre estrazione flessibile



ARMADIO CON 8 CASSETTI 1X50 2X75 3X100 1X150 1X250



ART.	cassetti		RAL	€
M43A100C010BQPD	100-75-50	92-96-100%	7035+7016	1427,10
M43A100C010BQ08	100-75-50	92-96-100%	7035	1313,40
M43A100C010BQ04	100-75-50	92-96-100%	5012	1313,40
M43A100C010BRPD	200	100%	7035+7016	1643,40
M43A100C010BR08	200	100%	7035	1529,70
M43A100C010BR04	200	100%	5012	1529,70

CONFIGURE

H=1000 mm I cassetti H=50 mm hanno sempre estrazione flessibile

ARMADIO CON 9 CASSETTI 3X50 2X75 2X100 1X150 1X250



ART.	cassetti		RAL	€
M43A100C010CSPD	100-75-50	92-96-100%	7035+7016	1535,40
M43A100C010CS08	100-75-50	92-96-100%	7035	1407,00
M43A100C010CS04	100-75-50	92-96-100%	5012	1407,00
M43A100C010CTPD	200	100%	7035+7016	1720,80
M43A100C010CT08	200	100%	7035	1592,40
M43A100C010CT04	200	100%	5012	1592,40

CONFIGURE

H=1000 mm I cassetti H=50 mm hanno sempre estrazione flessibile

ARMADIO CON 9 CASSETTI 3X100 4X150 1X200 1X300



ART.	cassetti		RAL	€
M43A150C010FAPD	100-75-50	92-96-100%	7035+7016	1733,10
M43A150C010FA08	100-75-50	92-96-100%	7035	1611,30
M43A150C010FA04	100-75-50	92-96-100%	5012	1611,30
M43A150C010FBPD	200	100%	7035+7016	2011,20
M43A150C010FB08	200	100%	7035	1889,40
M43A150C010FB04	200	100%	5012	1889,40

CONFIGURE

H=1500 mm

ARMADIO CON 9 CASSETTI 8X150 1X200



ART.	cassetti		RAL	€
M43A150C010EYPD	100-75-50	92-96-100%	7035+7016	1714,20
M43A150C010EY08	100-75-50	92-96-100%	7035	1609,80
M43A150C010EY04	100-75-50	92-96-100%	5012	1609,80
M43A150C010EZPD	200	100%	7035+7016	1992,30
M43A150C010EZ08	200	100%	7035	1887,90
M43A150C010EZ04	200	100%	5012	1887,90

CONFIGURE

H=1500 mm



DIM. INTERNE LxP



PORTATA



ESTRAZIONE



RAL 7035 + RAL 7016



RAL 5012



RAL 7035



MATERIALE DI SEPARAZIONE



ART.	adatto per cassetto H mm	componenti	€
FFH30051000	50/300	130 x Divisorio trasversale L=36 mm 20 x Divisorio a 4 canali	47,70



ART.	adatto per cassetto H mm	componenti	€
FFH30051200	50/300	100 x Divisorio trasversale L=47 mm 20 x Divisorio a 3 canali	45,00



ART.	adatto per cassetto H mm	componenti	€
FFH30050700	50	20 x Cassetta divisorio 75x75 mm 20 x Cassetta divisorio 150x75 mm 5 x Cassetta divisorio 150x150 mm	37,20
FFH30070700	75		46,50

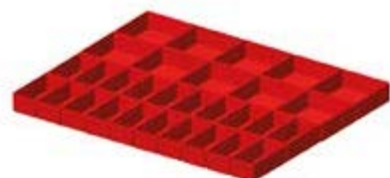

ART.	adatto per cassetto H mm	componenti	€
FFH30050800	50	20 x Cassetta divisorio 150x75 mm 10 x Cassetta divisorio 150x150 mm	32,70
FFH30070800	75		42,30
FFH30100800	100/125		48,30



ART.	adatto per cassetto H mm	componenti	€
FFH30050900	50	20 x Cassetta divisorio 150x150 mm	30,60
FFH30070900	75		39,30
FFH30100900	100/125		42,90



ART.	adatto per cassetto H mm	componenti	€
FFH30100200	100/125	2 x Divisorio longitudinale fessurato L=610 mm 8 x Divisorio trasversale L=253 mm	21,90
FFH30150200	150/175		27,00
FFH30200200	200/250		45,00
FFH30300200	300		74,70



MATERIALE DI SEPARAZIONE



ART.	adatto per cassetto H mm	componenti	€
FFH30070300	75	4 x Divisorio longitudinale fessurato L=610 mm 21 x Divisorio trasversale L=151 mm	26,40
FFH30100300	100/125		32,70
FFH30150300	150/175		47,10
FFH30200300	200/250		71,10
FFH30300300	300		139,50



ART.	adatto per cassetto H mm	componenti	€
FFH30070400	75	3 x Divisorio longitudinale fessurato L=610 mm 5 x Divisorio trasversale L=151 mm 10 x Divisorio trasversale L=202 mm	24,00
FFH30100400	100/125		31,50
FFH30150400	150/175		40,20
FFH30200400	200/250		66,00
FFH30300400	300		129,60





ARMADIO CON 5 CASSETTI 3X100 1X150 1X300



ART.	cassetti		RAL	€
M53A085C010AKPD	100-75-50	92-96-100%	7035+7016	1071,30
M53A085C010AK08	100-75-50	92-96-100%	7035	973,80
M53A085C010AK04	100-75-50	92-96-100%	5012	973,80
M53A085C010ALPD	200	100%	7035+7016	1225,80
M53A085C010AL08	200	100%	7035	1128,30
M53A085C010AL04	200	100%	5012	1128,30

CONFIGURE

H=850 mm

ARMADIO CON 6 CASSETTI 2X75 2X100 1X150 1X250



ART.	cassetti		RAL	€
M53A085C010AMPD	100-75-50	92-96-100%	7035+7016	1174,50
M53A085C010AM08	100-75-50	92-96-100%	7035	1056,30
M53A085C010AM04	100-75-50	92-96-100%	5012	1056,30
M53A085C010ANPD	200	100%	7035+7016	1359,90
M53A085C010AN08	200	100%	7035	1241,70
M53A085C010AN04	200	100%	5012	1241,70

CONFIGURE

H=850 mm

ARMADIO CON 7 CASSETTI 1X50 2X75 2X100 1X150 1X200



ART.	cassetti		RAL	€
M53A085C010AEPD	100-75-50	92-96-100%	7035+7016	1286,10
M53A085C010AE08	100-75-50	92-96-100%	7035	1144,80
M53A085C010AE04	100-75-50	92-96-100%	5012	1144,80
M53A085C010AFPD	200	100%	7035+7016	1471,50
M53A085C010AF08	200	100%	7035	1330,20
M53A085C010AF04	200	100%	5012	1330,20

CONFIGURE

H=850 mm I cassetti H=50 mm hanno sempre estrazione flessibile

ARMADIO CON 5 CASSETTI 2X100 2X200 1X300



ART.	cassetti		RAL	€
M53A100C010EAPD	100-75-50	92-96-100%	7035+7016	1118,70
M53A100C010EA08	100-75-50	92-96-100%	7035	1023,60
M53A100C010EA04	100-75-50	92-96-100%	5012	1023,60
M53A100C010EBPD	200	100%	7035+7016	1273,20
M53A100C010EB08	200	100%	7035	1178,10
M53A100C010EB04	200	100%	5012	1178,10

CONFIGURE

H=1000 mm



ARMADIO CON 6 CASSETTI 1X100 4X150 1X200



ART.	cassetti		RAL	€
M53A100C010DBPD	100-75-50	92-96-100%	7035+7016	1234,20
M53A100C010DB08	100-75-50	92-96-100%	7035	1121,10
M53A100C010DB04	100-75-50	92-96-100%	5012	1121,10
M53A100C010DCPD	200	100%	7035+7016	1419,60
M53A100C010DC08	200	100%	7035	1306,50
M53A100C010DC04	200	100%	5012	1306,50

CONFIGURE

H=1000 mm



ARMADIO CON 7 CASSETTI 1X50 2X75 2X100 1X200 1X300

ART.	cassetti		RAL	€
M53A100C010BNPD	100-75-50	92-96-100%	7035+7016	1330,80
M53A100C010BN08	100-75-50	92-96-100%	7035	1188,90
M53A100C010BN04	100-75-50	92-96-100%	5012	1188,90
M53A100C010BPPD	200	100%	7035+7016	1516,20
M53A100C010BP08	200	100%	7035	1374,30
M53A100C010BP04	200	100%	5012	1374,30

CONFIGURE

H=1000 mm I cassetti H=50 mm hanno sempre estrazione flessibile



ARMADIO CON 7 CASSETTI 2X75 1X100 3X150 1X200

ART.	cassetti		RAL	€
M53A100C010AWPD	100-75-50	92-96-100%	7035+7016	1338,60
M53A100C010AW08	100-75-50	92-96-100%	7035	1203,00
M53A100C010AW04	100-75-50	92-96-100%	5012	1203,00
M53A100C010BH04	200	100%	7035+7016	1554,90
M53A100C010BH08	200	100%	7035	1419,30
M53A100C010BH04	200	100%	5012	1419,30

CONFIGURE

H=1000 mm



ARMADIO CON 8 CASSETTI 1X50 2X75 2X100 2X150 1X200

ART.	cassetti		RAL	€
M53A100C010CUPD	100-75-50	92-96-100%	7035+7016	1446,30
M53A100C010CU08	100-75-50	92-96-100%	7035	1286,40
M53A100C010CU04	100-75-50	92-96-100%	5012	1286,40
M53A100C010CVPD	200	100%	7035+7016	1662,60
M53A100C010CV08	200	100%	7035	1502,70
M53A100C010CV04	200	100%	5012	1502,70

CONFIGURE

H=1000 mm I cassetti H=50 mm hanno sempre estrazione flessibile



DIM. INTERNE LxP



PORTATA



ESTRAZIONE



RAL 7035 + RAL 7016



RAL 5012



RAL 7035



ARMADIO CON 8 CASSETTI 2X75 3X100 3X150

ART.	cassetti		RAL	€
M53A100C010DDPD	100-75-50	92-96-100%	7035+7016	1451,70
M53A100C010DD08	100-75-50	92-96-100%	7035	1294,50
M53A100C010DD04	100-75-50	92-96-100%	5012	1294,50
M53A100C010DEPD	200	100%	7035+7016	1698,90
M53A100C010DE08	200	100%	7035	1541,70
M53A100C010DE04	200	100%	5012	1541,70

CONFIGURE

H=1000 mm



ARMADIO CON 10 CASSETTI 1X50 2X75 7X100

ART.	cassetti		RAL	€
M53A100C010DFPD	100-75-50	92-96-100%	7035+7016	1672,50
M53A100C010DF08	100-75-50	92-96-100%	7035	1469,40
M53A100C010DF04	100-75-50	92-96-100%	5012	1469,40
M53A100C010DGPDP	200	100%	7035+7016	1950,60
M53A100C010DG08	200	100%	7035	1747,50
M53A100C010DG04	200	100%	5012	1747,50

CONFIGURE

H=1000 mm I cassetti H=50 mm hanno sempre estrazione flessibile



ARMADIO CON 9 CASSETTI 2X75 2X100 1X150 3X200 1X300

ART.	cassetti		RAL	€
M53A150C010LXPD	100-75-50	92-96-100%	7035+7016	1732,80
M53A150C010LX08	100-75-50	92-96-100%	7035	1559,70
M53A150C010LX04	100-75-50	92-96-100%	5012	1559,70
M53A150C010LYPD	200	100%	7035+7016	2010,90
M53A150C010LY08	200	100%	7035	1837,80
M53A150C010LY04	200	100%	5012	1837,80

CONFIGURE

H=1500 mm



ARMADIO CON 9 CASSETTI 2X100 6X150 1X300

ART.	cassetti		RAL	€
M53A150C010FJPD	100-75-50	92-96-100%	7035+7016	1741,50
M53A150C010FJ08	100-75-50	92-96-100%	7035	1569,30
M53A150C010FJ04	100-75-50	92-96-100%	5012	1569,30
M53A150C010FKPD	200	100%	7035+7016	2019,60
M53A150C010FK08	200	100%	7035	1847,40
M53A150C010FK04	200	100%	5012	1847,40

CONFIGURE

H=1500 mm



ARMADIO CON 10 CASSETTI 1X50 4X100 1X150 4X200



ART.	cassetti		RAL	€
	KG			
M53A150C010LZPD	100-75-50	92-96-100%	7035+7016	1851,90
M53A150C010LZ08	100-75-50	92-96-100%	7035	1658,70
M53A150C010LZ04	100-75-50	92-96-100%	5012	1658,70
M53A150C010MAPD	200	100%	7035+7016	2130,00
M53A150C010MA08	200	100%	7035	1936,80
M53A150C010MA04	200	100%	5012	1936,80

H=1500 mm I cassetti H=50 mm hanno sempre estrazione flessibile

[CONFIGURE](#)



ARMADIO 2XPF 2XPE



ART.	piani estraibili		RAL	€
	KG			
M53A200C010SVPD	200	100%	7035+7016	1165,80
M53A200C010SV08	200	100%	7035	1124,40
M53A200C010SV04	200	100%	5012	1124,40

H=2000 mm

[CONFIGURE](#)



ARMADIO CON 4 CASSETTI 2XPF 1X150 1X200 1X250 1X300



ART.	cassetti		RAL	€
	KG			
M53A200C010SXPD	200	100%	7035+7016	1545,00
M53A200C010SX08	200	100%	7035	1470,30
M53A200C010SX04	200	100%	5012	1470,30

H=2000 mm

[CONFIGURE](#)

PE: PIANO ESTRAIBILE
PF: PIANO FESSURATO



DIM. INTERNE LxP



PORTATA



ESTRAZIONE



RAL 7035 + RAL 7016



RAL 5012



RAL 7035



ARMADIO CON 7 CASSETTI 2XPF 1X50 1X75 1X100 1X125 1X150 2X200

ART.	cassetti		RAL	€
M53A200C010SWPD	200	100%	7035+7016	1940,70
M53A200C010SW08	200	100%	7035	1803,30
M53A200C010SW04	200	100%	5012	1803,30

H=2000 mm I cassetti H=50 mm hanno sempre estrazione flessibile

CONFIGURE



ARMADIO CON PORTE 2XPF 2XPE

ART.	piani estraibili		RAL	€
M53A200C010SUPD	100-75-50	92-96-100%	7035+7016	1253,10
M53A200C010SU08	100-75-50	92-96-100%	7035	1253,10
M53A200C010SU04	100-75-50	92-96-100%	5012	1253,10

H=2000 mm

CONFIGURE



ARMADIO CON PORTE CON 7 CASSETTI 3XPR 2X75 1X100 3X150 1X200

ART.	cassetti		RAL	€
M53A200C010FYPD	100-75-50	92-96-100%	7035+7016	2149,50
M53A200C010FY08	100-75-50	92-96-100%	7035	2013,90
M53A200C010FY04	100-75-50	92-96-100%	5012	2013,90
M53A200C010FZPD	200	100%	7035+7016	2365,80
M53A200C010FZ08	200	100%	7035	2230,20
M53A200C010FZ04	200	100%	5012	2230,20

H=2000 mm

CONFIGURE



ARMADIO CON PORTE CON 3 CASSETTI 2XPR 2X100 1X150 2XPE



ART.	cassetti / piani estraibili		RAL	€
	KG			
M53A200C010FWPD	100-75-50	92-96-100%	7035+7016	1655,10
M53A200C010FW08	100-75-50	92-96-100%	7035	1655,10
M53A200C010FW04	100-75-50	92-96-100%	5012	1655,10
M53A200C010FXPD	200	100%	7035+7016	1809,60
M53A200C010FX08	200	100%	7035	1809,60
M53A200C010FX04	200	100%	5012	1809,60

H=2000 mm

CONFIGURE



ARMADIO CON RUOTE CON 7 CASSETTI 2X75 3X100 2X150



ART.	cassetti		RAL	€
	KG			
M53R085C01095PD	100-75-50	92-96-100%	7035+7016	1646,10
M53R085C0109508	100-75-50	92-96-100%	7035	1507,50
M53R085C0109504	100-75-50	92-96-100%	5012	1507,50

H=1072 mm

Ruote: Gomma elastica Ø 160 mm
 Portata armadio: 900 kg

CONFIGURE



PE: PIANO ESTRAIBILE
 PR: PIANO REGOLABILE
 PF: PIANO FESSURATO



DIM. INTERNE LxP



PORTATA



ESTRAZIONE



RAL 7035 + RAL 7016



RAL 5012



RAL 7035



MATERIALE DI SEPARAZIONE



ART.	adatto per cassetto H mm	componenti	€
FFH50050900	50/300	15 x Divisorio trasversale L=36 mm 10 x Divisorio trasversale L=47 mm 6 x Divisorio trasversale L=73 mm 8 x Divisorio a 2 canali 8 x Divisorio a 3 canali 8 x Divisorio a 4 canali	43,50



ART.	adatto per cassetto H mm	componenti	€
FFH50051900	50/300	30 x Divisorio trasversale L=36 mm 10 x Divisorio trasversale L=47 mm 8 x Divisorio a 3 canali 16 x Divisorio a 4 canali	48,60



ART.	adatto per cassetto H mm	componenti	€
FFH50050800	50	12 x Cassetta divisorio 150x75 mm 18 x Cassetta divisorio 150x150 mm	39,60
FFH50070800	75		53,40
FFH50100800	100/125		60,00



ART.	adatto per cassetto H mm	componenti	€
FFH50051700	50	12 x Cassetta divisorio 150x150 mm	43,80
FFH50071700	75		57,90



ART.	adatto per cassetto H mm	componenti	€
FFH50051800	50	24 x Cassetta divisorio 150x150 mm	38,10
FFH50071800	75		51,60
FFH50101800	100/125		57,00



ART.	adatto per cassetto H mm	componenti	€
FFH50050700	50	4 x Divisorio longitudinale fessurato L=610 mm 2 x Divisorio trasversale L=151 mm 3 x Divisorio trasversale L=202 mm	22,80
FFH50070700	75		22,80
FFH50100700	100/125		25,80
FFH50150700	150/175		30,00
FFH50200700	200/250		53,40
FFH50300700	300		120,30



MATERIALE DI SEPARAZIONE



ART.	adatto per cassetto H mm	componenti	€
FFH50051000	50	2 x Divisorio longitudinale fessurato L=610 mm 2 x Divisorio trasversale L=304 mm	15,00
FFH50071000	75		15,00
FFH50101000	100/125		15,90
FFH50151000	150/175		17,40
FFH50201000	200/250		26,70
FFH50301000	300		63,60



ART.	adatto per cassetto H mm	componenti	€
FFH50051300	50	5 x Divisorio longitudinale fessurato L=610 mm 12 x Divisorio trasversale L=151 mm	29,70
FFH50071300	75		24,00
FFH50101300	100/125		30,00
FFH50151300	150/175		43,50
FFH50201300	200/250		75,30
FFH50301300	300		161,70



ART.	adatto per cassetto H mm	componenti	€
FFH50051500	50	7 x Divisorio longitudinale fessurato L=610 mm 12 x Divisorio trasversale L=100 mm 2 x Divisorio trasversale L=151 mm	35,70
FFH50071500	75		30,30
FFH50101500	100/125		38,40





ARMADIO CON 7 CASSETTI 2X75 2X100 1X150 2X200



ART.	cassetti		RAL	€
M63A100C010DYPD	100-75-50	92-96-100%	7035+7016	1544,70
M63A100C010DY08	100-75-50	92-96-100%	7035	1500,90
M63A100C010DY04	100-75-50	92-96-100%	5012	1500,90
M63A100C010DZPD	200	100%	7035+7016	1761,00
M63A100C010DZ08	200	100%	7035	1717,20
M63A100C010DZ04	200	100%	5012	1717,20

CONFIGURE

H=1000 mm

ARMADIO CON 8 CASSETTI 2X75 4X100 1X150 1X200



ART.	cassetti		RAL	€
M63A100C010CNPD	100-75-50	92-96-100%	7035+7016	1670,70
M63A100C010CN08	100-75-50	92-96-100%	7035	1625,10
M63A100C010CN04	100-75-50	92-96-100%	5012	1625,10
M63A100C010CPPD	200	100%	7035+7016	1917,90
M63A100C010CP08	200	100%	7035	1872,30
M63A100C010CP04	200	100%	5012	1872,30

CONFIGURE

H=1000 mm

ARMADIO CON 8 CASSETTI 2X75 3X100 3X150



ART.	cassetti		RAL	€
M63A100C010DDPD	100-75-50	92-96-100%	7035+7016	1668,60
M63A100C010DD08	100-75-50	92-96-100%	7035	1617,30
M63A100C010DD04	100-75-50	92-96-100%	5012	1617,30
M63A100C010DEPD	200	100%	7035+7016	1915,80
M63A100C010DE08	200	100%	7035	1864,50
M63A100C010DE04	200	100%	5012	1864,50

CONFIGURE

H=1000 mm

ARMADIO CON 10 CASSETTI 2X150 1X125 1X75 2X100 2X150 2X200



ART.	cassetti		RAL	€
M63A150C010MCPD	200	100%	7035+7016	2490,30
M63A150C010MC08	200	100%	7035	2412,00
M63A150C010MC04	200	100%	5012	2412,00

CONFIGURE

H=1500 mm



ARMADIO CON 11 CASSETTI 1X150 1X125 1X75 4X100 3X150 1X200

ART.	cassetti		RAL	€
M63A150C010MEPD	200	100%	7035+7016	2647,20
M63A150C010ME08	200	100%	7035	2567,10
M63A150C010ME04	200	100%	5012	2567,10

H=1500 mm

CONFIGURE



ARMADIO CON 7 CASSETTI 2XPR 2X75 1X100 3X150 1X200

ART.	cassetti		RAL	€
M63A200C010FTPD	200	100%	7035+7016	2320,50
M63A200C010FT08	200	100%	7035	2271,30
M63A200C010FT04	200	100%	5012	2271,30

H=2000 mm

CONFIGURE



ARMADIO CON PORTE CON 7 CASSETTI 3XPR 2X75 1X100 3X150 1X200

ART.	cassetti		RAL	€
M63A200C010FZPD	200	100%	7035+7016	2748,30
M63A200C010FZ08	200	100%	7035	2698,80
M63A200C010FZ04	200	100%	5012	2698,80

H=2000 mm

CONFIGURE



PR: PIANO REGOLABILE



DIM. INTERNE LxP



PORTATA



ESTRAZIONE



RAL 7035 + RAL 7016



RAL 5012

RAL 7035



MATERIALE DI SEPARAZIONE



ART.	adatto per cassetto H mm	componenti	€
FFH60070200	75	4 x Divisorio longitudinale fessurato L=610 mm 3 x Divisorio trasversale L=151 mm 3 x Divisorio trasversale L=168 mm 9 x Divisorio trasversale L=253 mm	28,20
FFH60100200	100/125		33,60
FFH60150200	150/175		48,60
FFH60200200	200/250		69,00

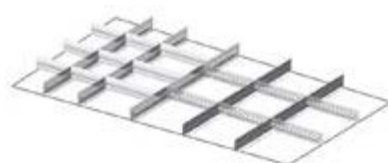

ART.	adatto per cassetto H mm	componenti	€
FFH60070500	75	5 x Divisorio longitudinale fessurato L=610 mm 6 x Divisorio trasversale L=134 mm 9 x Divisorio trasversale L=202 mm	28,80
FFH60100500	100/125		34,80
FFH60150500	150/175		50,40

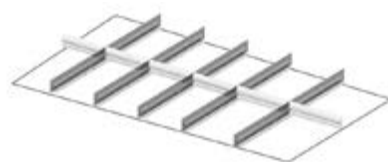

ART.	adatto per cassetto H mm	componenti	€
FFH60070800	75	5 x Divisorio longitudinale fessurato L=610 mm 2 x Divisorio trasversale L=151 mm 1 x Divisorio trasversale L=168 mm 3 x Divisorio trasversale L=202 mm	20,70
FFH60100800	100/125		26,40
FFH60150800	150/175		37,50
FFH60200800	200/250		57,30
FFH60300800	300		128,40

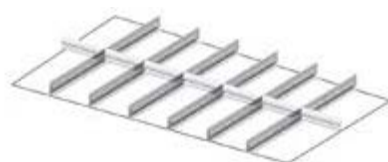

ART.	adatto per cassetto H mm	componenti	€
FFH60071100	75	6 x Divisorio longitudinale fessurato L=610 mm 6 x Divisorio trasversale L=151 mm 1 x Divisorio trasversale L=168 mm	24,00
FFH60101100	100/125		30,60
FFH60151100	150/175		43,20
FFH60201100	200/250		66,30
FFH60301100	300		150,60





ARMADIO CON 5 CASSETTI 2X100 2X200 1X300



ART.	cassetti		RAL	€
M73A100C010EAPD	100-75-50	92-96-100%	7035+7016	1518,30
M73A100C010EA08	100-75-50	92-96-100%	7035	1430,10
M73A100C010EA04	100-75-50	92-96-100%	5012	1430,10
M73A100C010EBPD	200	100%	7035+7016	1672,80
M73A100C010EB08	200	100%	7035	1584,60
M73A100C010EB04	200	100%	5012	1584,60

CONFIGURE

H=1000 mm

ARMADIO CON 7 CASSETTI 2X75 2X100 1X150 2X200



ART.	cassetti		RAL	€
M73A100C010DYPD	100-75-50	92-96-100%	7035+7016	1781,70
M73A100C010DY08	100-75-50	92-96-100%	7035	1654,50
M73A100C010DY04	100-75-50	92-96-100%	5012	1654,50
M73A100C010DZPD	200	100%	7035+7016	1998,00
M73A100C010DZ08	200	100%	7035	1870,80
M73A100C010DZ04	200	100%	5012	1870,80

CONFIGURE

H=1000 mm

ARMADIO CON 8 CASSETTI 2X75 4X100 1X150 1X200



ART.	cassetti		RAL	€
M73A100C010CNPD	100-75-50	92-96-100%	7035+7016	1946,10
M73A100C010CN08	100-75-50	92-96-100%	7035	1785,00
M73A100C010CN04	100-75-50	92-96-100%	5012	1785,00
M73A100C010CPPD	200	100%	7035+7016	2193,30
M73A100C010CP08	200	100%	7035	2032,20
M73A100C010CP04	200	100%	5012	2032,20

CONFIGURE

H=1000 mm

ARMADIO CON 10 CASSETTI 2X150 1X125 1X75 2X100 2X150 2X200



ART.	cassetti		RAL	€
M73A150C010MCPD	200	100%	7035+7016	2762,40
M73A150C010MC08	200	100%	7035	2588,70
M73A150C010MC04	200	100%	5012	2588,70

CONFIGURE

H=1500 mm



ARMADIO CON 11 CASSETTI 1X150 1X125 1X75 4X100 3X150 1X200

ART.	cassetti		RAL	€
M73A150C010MEPD	200	100%	7035+7016	2957,70
M73A150C010ME08	200	100%	7035	2750,40
M73A150C010ME04	200	100%	5012	2750,40

H=1500 mm

CONFIGURE



ARMADIO CON 7 CASSETTI 2XPR 2X75 1X100 3X150 1X200

ART.	cassetti		RAL	€
M73A200C010FTPD	200	100%	7035+7016	2524,20
M73A200C010FT08	200	100%	7035	2405,70
M73A200C010FT04	200	100%	5012	2405,70

H=2000 mm

CONFIGURE



ARMADIO CON PORTE CON 7 CASSETTI 3XPR 2X75 1X100 3X150 1X200

ART.	cassetti		RAL	€
M73A200C010FZPD	200	100%	7035+7016	2968,80
M73A200C010FZ08	200	100%	7035	2850,30
M73A200C010FZ04	200	100%	5012	2850,30

H=2000 mm

CONFIGURE



MATERIALE DI SEPARAZIONE

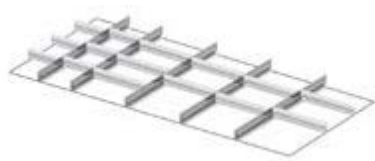

ART.	adatto per cassetto H mm	componenti	€
FFH70070200	75		30,60
FFH70100200	100/125	5 x Divisorio longitudinale fessurato L=610 mm 6 x Divisorio trasversale L=151 mm	36,60
FFH70150200	150/175	9 x Divisorio trasversale L=253 mm	52,80
FFH70200200	200/250		77,70



ART.	adatto per cassetto H mm	componenti	€
FFH70070300	75		36,30
FFH70100300	100/125	6 x Divisorio longitudinale fessurato L=610 mm 3 x Divisorio trasversale L=134 mm	44,10
FFH70150300	150/175	3 x Divisorio trasversale L=168 mm 14 x Divisorio trasversale L=202 mm	64,20

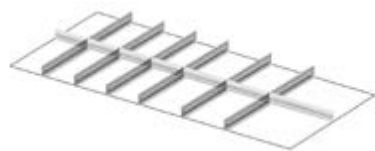

ART.	adatto per cassetto H mm	componenti	€
FFH70070700	75		24,90
FFH70100700	100/125	6 x Divisorio longitudinale fessurato L=610 mm	31,20
FFH70150700	150/175	4 x Divisorio trasversale L=151 mm 2 x Divisorio trasversale L=202 mm	44,40
FFH70200700	200/250	1 x Divisorio trasversale L=304 mm	68,70
FFH70300700	300		154,80

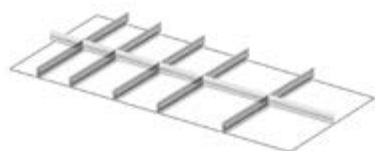

ART.	adatto per cassetto H mm	componenti	€
FFH70070800	75		21,90
FFH70100800	100/125	5 x Divisorio longitudinale fessurato L=610 mm	27,30
FFH70150800	150/175	2 x Divisorio trasversale L=151 mm 2 x Divisorio trasversale L=202 mm	38,70
FFH70200800	200/250	2 x Divisorio trasversale L=304 mm	59,10
FFH70300800	300		133,20













MASTER

ACCESSORI













TOP IN ACCIAIO INOX

ART.	adatto per armadio EH	L mm	P mm	H mm	€
 M12T030MDNX710A	18x27	408	573	31	136,50
 M22T030MDNX710A	27x27	561	573	31	156,30
 M32T030MDNX710A	36x27	714	573	31	177,30
 M52T030MDNX710A	54x27	1020	573	31	220,80
 M23T030MDNX710A	27x36	561	726	31	177,90
 M33T030MDNX710A	36x36	714	726	31	203,70
 M43T030MDNX710A	45x36	867	726	31	232,20
 M53T030MDNX710A	54x36	1020	726	31	255,30
 M63T030MDNX710A	64x36	1190	726	31	285,00
 M73T030MDNX710A	78x36	1428	726	31	325,80



TOP IN ACCIAIO GOMMATO

ART.	adatto per armadio EH	L mm	P mm	H mm	colore	€
 M12T030MDGM7107	18x27	408	573	32	Nero	126,60
 M22T030MDGM7107	27x27	561	573	32	Nero	147,30
 M32T030MDGM7107	36x27	714	573	32	Nero	155,10
 M52T030MDGM7107	54x27	1020	573	32	Nero	215,40
 M23T030MDGM7107	27x36	561	726	32	Nero	156,00
 M33T030MDGM7107	36x36	714	726	32	Nero	164,10
 M43T030MDGM7107	45x36	867	726	32	Nero	191,70
 M53T030MDGM7107	54x36	1020	726	32	Nero	226,80
 M63T030MDGM7107	64x36	1190	726	32	Nero	238,20
 M73T030MDGM7107	78x36	1428	726	32	Nero	254,40



TOP IN MULTIPLEX

ART.	adatto per armadio EH	L mm	P mm	H mm	€
 M12T030MU000100	18x27	408	573	30	76,50
 M22T030MU000100	27x27	561	573	30	86,70
 M32T030MU000100	36x27	714	573	30	90,60
 M52T030MU000100	54x27	1020	573	30	110,70
 M23T030MU000100	27x36	561	726	30	97,50
 M33T030MU000100	36x36	714	726	30	103,20
 M43T030MU000100	45x36	867	726	30	124,80
 M53T030MU000100	54x36	1020	726	30	123,90
 M63T030MU000100	64x36	1190	726	30	141,30
 M73T030MU000100	78x36	1428	726	30	157,50



TOP A 3 BORDI RIVESTITO IN PVC

ART.	adatto per armadio EH	L mm	P mm	H mm	colore	€
M12T023AG003107	18x27	409	576	23	Nero	51,60
M22T023AG003107	27x27	562	576	23	Nero	57,30
M32T023AG003107	36x27	715	576	23	Nero	61,50
M52T023AG003107	54x27	1021	576	23	Nero	81,90
M23T023AG003107	27x36	562	729	23	Nero	61,50
M33T023AG003107	36x36	715	729	23	Nero	86,10
M43T023AG003107	45x36	868	729	23	Nero	92,70
M53T023AG003107	54x36	1021	729	23	Nero	88,50
M63T023AG003107	64x36	1191	729	23	Nero	95,10
M73T023AG003107	78x36	1429	729	23	Nero	95,10

ZOCCOLO DI RIALZO H=50 mm



ART.	adatto per armadio EH	L mm	P mm	H mm	RAL	€
M12Z05000000008	18x27	406	572	50	7035	58,20
M12Z05000000004	18x27	406	572	50	5012	58,20
M22Z05000000008	27x27	559	572	50	7035	61,20
M22Z05000000004	27x27	559	572	50	5012	61,20
M32Z05000000008	36x27	712	572	50	7035	62,40
M32Z05000000004	36x27	712	572	50	5012	62,40
M52Z05000000008	54x27	1018	572	50	7035	68,10
M52Z05000000004	54x27	1018	572	50	5012	68,10
M23Z05000000008	27x36	559	725	50	7035	59,10
M23Z05000000004	27x36	559	725	50	5012	59,10
M33Z05000000008	36x36	712	725	50	7035	64,20
M33Z05000000004	36x36	712	725	50	5012	64,20
M43Z05000000008	45x36	865	725	50	7035	67,80
M43Z05000000004	45x36	865	725	50	5012	67,80
M53Z05000000008	54x36	1018	725	50	7035	65,70
M53Z05000000004	54x36	1018	725	50	5012	65,70
M63Z05000000008	64x36	1188	725	50	7035	74,10
M63Z05000000004	64x36	1188	725	50	5012	74,10
M73Z05000000008	78x36	1426	725	50	7035	75,90
M73Z05000000004	78x36	1426	725	50	5012	75,90



ZOCCOLO DI RIALZO H=100 mm

ART.	adatto per armadio EH	L mm	P mm	H mm	RAL	€
 M12Z10000000008	18x27	406	572	100	7035	61,20
 M12Z10000000004	18x27	406	572	100	5012	61,20
 M22Z10000000008	27x27	559	572	100	7035	63,30
 M22Z10000000004	27x27	559	572	100	5012	63,30
 M32Z10000000008	36x27	712	572	100	7035	68,10
 M32Z10000000004	36x27	712	572	100	5012	68,10
 M52Z10000000008	54x27	1018	572	100	7035	74,10
 M52Z10000000004	54x27	1018	572	100	5012	74,10
 M23Z10000000008	27x36	559	725	100	7035	65,70
 M23Z10000000004	27x36	559	725	100	5012	65,70
 M33Z10000000008	36x36	712	725	100	7035	69,00
 M33Z10000000004	36x36	712	725	100	5012	69,00
 M43Z10000000008	45x36	865	725	100	7035	74,40
 M43Z10000000004	45x36	865	725	100	5012	74,40
 M53Z10000000008	54x36	1018	725	100	7035	76,50
 M53Z10000000004	54x36	1018	725	100	5012	76,50
 M63Z10000000008	64x36	1188	725	100	7035	81,30
 M63Z10000000004	64x36	1188	725	100	5012	81,30
 M73Z10000000008	78x36	1426	725	100	7035	85,50
 M73Z10000000004	78x36	1426	725	100	5012	85,50



MASTER

ACCESSORI



ZOCCOLO PER CARRELLO ELEVATORE E TRANSPALLET

ART.	adatto per armadio EH	L mm	P mm	H mm	RAL	€
M32Z1001000007	36x27	712	569	100	9005	89,10
M23Z1001000007	27x36	559	722	100	9005	94,50
M33Z1001000007	36x36	712	722	100	9005	96,30
M43Z1001000007	45x36	865	722	100	9005	120,00

CHIUSURA PER ZOCCOLO



ART.	adatto per armadio L EH	L mm	P mm	H mm	RAL	€
M20Z10011000007	27	555	46	95	9005	30,90
M30Z10011000007	36	708	46	95	9005	19,80
M40Z10011000007	45	861	46	95	9005	31,20



COPPIA ZOCCOLI PER CARRELLO ELEVATORE E TRANSPALLET

ART.	adatto per armadio EH	L mm	P mm	H mm	RAL	€
M02Z10020000007	54x27	200	569	100	9005	68,70
M03Z10020000007	54x36 64x36 78x36	200	722	100	9005	76,50

CHIUSURA PER ZOCCOLO



ART.	adatto per armadio L EH	L mm	P mm	H mm	RAL	€
M50Z10021000007	54	1014	46	95	9005	28,80
M60Z10021000007	64	1184	46	95	9005	32,40
M70Z10021000007	78	1422	46	95	9005	35,40



RAL 5012



RAL 7035



RAL 9005

MASTER CS

STANDARD CS

POSTAZIONE PC
SERIE PRO+

POSTAZIONE PC
SERIE PRO



Gli armadi porta PC della serie Master CS e Standard CS sono impiegati come **postazioni di lavoro** in reparti, aree produttive e magazzini. La resistente struttura in metallo, infatti, protegge **computer e hardware** da sporcizia e possibili urti ed è dotata di fori per cavi di rete, per il cavo elettrico e di un foro di entrata dell'aria con filtro antipolvere. **Standard CS** è una soluzione **monoblocco** con vano porta schermi, cassetto e vano inferiore con ante a battenti e piani. **Master CS**, invece, è **componibile** e presenta un armadio inferiore ad ante a battenti con cassetto e piani, mentre la parte superiore può essere lasciata libera oppure allestita con un armadio con porta in policarbonato.

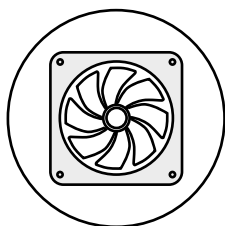

**VENTILAZIONE
FORZATA**

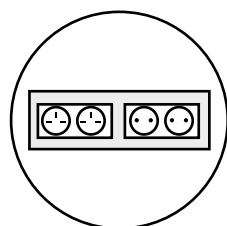

**IMPIANTO ELETTRICO
CON PRESE DE CH GB
FR**

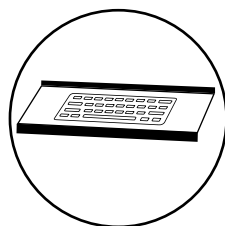

**PIANO PER TASTIERA
ESTRAIBILE**

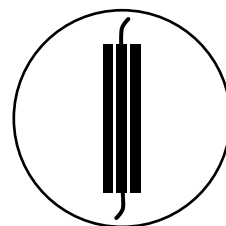

**CANALETTA PER
GESTIONE PASSAGGIO
CAVI**

ARMADI PORTA COMPUTER

MASTER CS

1. Porta con serratura di sicurezza e vetro in policarbonato.
Dimensioni utili: 655x215x465 mm H
2. Possibilità di inserimento video fino a 21".
Dimensioni interne del vano superiore: 710x215x530 mm H
3. Cassetto estraibile con piano porta tastiera e 2 posizioni di bloccaggio, in apertura spazio posteriore per contenimento oggetti.
Dimensioni utili: 655x465 mm H
4. Vano con possibilità di inserimento di piani estraibili e piani regolabili in altezza, per l'alloggiamento di sistemi hardware e stampanti.
Larghezza inserimento utile: 663 mm. Altezza utile: 754 mm
5. Foro per cavi di rete e foro di uscita del cavo per l'impianto elettrico
6. Foro di entrata dell'aria con filtro antipolvere
7. Impianto elettrico a 4 prese Schuko
8. Canalette porta cavi a 4 corsie
9. Ventola di raffreddamento con filtro antipolvere
10. Piano estraibile.
Dimensioni: 602x449 mm
11. Piano regolabile.
Dimensioni 663x560x52 mm H



Armadio acquistabile senza il modulo superiore. Ottimo per soluzioni con computer portatili e schermi touch screen.



STANDARD CS

12. Porta con serratura di sicurezza e vetro in policarbonato.
Dimensioni utili: 661x525 mm H
13. Possibilità di inserimento video fino a 21".
Dimensioni interne del vano superiore: 690x600x580 mm H
14. Piano porta tastiera.
Dimensioni utili: 620x510 mm H
15. Vano inferiore con possibilità di inserimento di piani estraibili e piani regolabili in altezza, per l'alloggiamento di sistemi hardware e stampanti.
Dimensioni interne: 690x600x720 mm H
16. Foro per cavi di rete e foro di uscita del cavo per l'impianto elettrico
17. Foro di entrata dell'aria con filtro antipolvere
18. Impianto elettrico a 4 prese Schuko
19. Canalette porta cavi a 4 corsie
20. Ventola di raffreddamento con filtro antipolvere
21. Piano estraibile.
Dimensioni: 650x582x36 mm H
22. Piano regolabile.
Dimensioni 688x591x38 mm H



MASTER CS

POSTAZIONE PC

CONFIGURE 

SHOP 

PATENTED*



ARMADIO PORTA COMPUTER CON RUOTE

ART.	L mm	P mm	H mm	 set ruote	RAL	€
MASTERCS01	792	617	1731	450	7035	1369,20

Composto da:

qtà	descrizione
1	Armadio inferiore con 1 cassetto
1	Armadio superiore con porta in policarbonato
1	Maniglia a tubo
1	Piano estraibile a estrazione flessibile con maniglia Dark Grey
1	Supporto presa
1	Multipresa schuko a 4 scomparti
1	Cavo di collegamento wieland schuko/francese
1	Ventola 230 V senza griglia con spina Schuko
1	Kit ruote in nylon Ø 100 mm



ARMADIO SUPERIORE CON PORTA IN POLICARBONATO

ART.	L mm	P mm	H mm	RAL	€
FAS1450C01008	714	247	650	7035	286,50



ARMADIO SUPERIORE CON TAPPARELLA

ART.	L mm	P mm	H mm	RAL	€
FAS1450C02008	714	247	650	7035	318,30

Possibilità di inserimento video fino a 24"

SHOP 

Possibilità di inserimento video fino a 24"

SHOP 



CONFIGURE 

SHOP 

PATENTED*



piano porta tastiera

ARMADIO INFERIORE CON 1 CASSETTO

ART.	L mm	P mm	H mm		n. cassette	n. piani porta tastiera	n. piani regolabili	RAL	€
FAS1400C00508	714	598	950	200	1	1	1	7035	837,00

MASTER CS

COMPONENTI

KIT RUOTE



ART.	Ø mm	KG	KG	H mm	materiale				€
FKRU1252101	125	100	300	155	Gomma antitraccia sintetica	-	2	2	53,40
FKRV1001107	100	150	450	128	Nylon	1	1	2	46,20



RUOTA GIREVOLE



RUOTA GIREVOLE CON FRENO



RUOTA FISSA



PIANO ESTRAIBILE A ESTRAZIONE FLESSIBILE CON MANIGLIA DARK GREY 36X27 EH

ART.	dim. utili		RAL	€
	L mm	P mm		
M32C05701101F39	602	449	7016	99,60

SHOP



MANIGLIA A TUBO

ART.	L mm	P mm	H mm	RAL	€
M02R00000000007	484	80	46	9005	14,40

SHOP



TOP A 3 BORDI RIVESTITO IN PVC CON FORO PASSACAVI 36X27 EH

ART.	L mm	P mm	H mm	colore	€
M32T023AG007107	715	576	31	Nero	61,80

SHOP



VENTOLA 230 V SENZA GRIGLIA CON SPINA SCHUKO

ART.	L mm	P mm	H mm	colore	€
FAS32200100	125	44	125	Nero	30,90

SHOP



SUPPORTO PRESA

ART.	L mm	P mm	H mm	finitura	€
FAS30210099	542	10	77	Zincato	9,60

SHOP



ESEMPI SCHEMA MULTIPRESE SU SUPPORTO PRESA



Con multipresa a 4 scomparti



Con multipresa a 2 scomparti + multipresa a 4 scomparti



Con magnetotermico + multipresa a 4 scomparti

IRONTEAM

vedi pag. 196



FBLET012007



FBLET004007



FBLET005007



FBLET016007



PORTATA



RAL 7016



RAL 7035



RAL 9005



ZINCATO

STANDARD CS

POSTAZIONE PC

[CONFIGURE](#)

[SHOP](#)

PATENTED



ARMADIO PORTA COMPUTER CON RUOTE

ART.	L mm	P mm	H mm	set ruote	RAL	€
STANDARDCS01	807	654	1688	450	7035	918,60

Composto da:

qtà	descrizione
1	Armadio porta computer
1	Maniglia a tubo
1	Supporto presa
1	Piano estraibile a estrazione semplice
1	Multipresa schuko a 4 scomparti
1	Cavo di collegamento wieland schuko/francese
1	Ventola 230 V senza griglia con spina Schuko
1	Kit ruote in nylon Ø 100 mm



[CONFIGURE](#)

ARMADIO PORTA COMPUTER



ART.	L mm	P mm	H mm	n. piani porta tastiera	n. piani regolabili	RAL	€	
FAS1600C00208	717	635	1560	400	1	2	7035	700,20
FAS1600C00204	717	635	1560	400	1	2	5012	700,20

STANDARD CS

COMPONENTI



KIT RUOTE



ART.	Ø mm	KG	KG	H mm	materiale				€
FKRU1252101	125	100	300	155	Gomma antitraccia sintetica	-	2	2	53,40
FKRV1001107	100	150	450	128	Nylon	1	1	2	46,20



RUOTA GIREVOLE



RUOTA GIREVOLE CON FRENO



RUOTA FISSA



PIANO ESTRAIBILE A ESTRAZIONE SEMPLICE

ART.	L mm	P mm	H mm	RAL	€
FAS2360S039	650	582	36	7016	70,80



PIANO REGOLABILE CON GANCI

ART.	L mm	P mm	H mm	RAL	€
FAS2040S139	688	591	38	7016	56,10



MANIGLIA A TUBO

ART.	L mm	P mm	H mm	RAL	€
FCL09950007	502	80	46	9005	15,90



VENTOLA 230 V SENZA GRIGLIA CON SPINA SCHUKO

ART.	L mm	P mm	H mm	colore	€
FAS32200100	125	44	125	Nero	30,90



COPPIA ZOCCOLI

ART.	L mm	P mm	H mm	RAL	€
FRR16250007	59	608	100	9005	45,60



SUPPORTO PRESA

ART.	L mm	P mm	H mm	finitura	€
FAS30210099	542	10	77	Zincato	9,60



ESEMPI SCHEMA MULTIPRESE SU SUPPORTO PRESA



Con multipresa a 4 scomparti



Con multipresa a 2 scomparti + multipresa a 4 scomparti



Con magnetotermico + multipresa a 4 scomparti



vedi pag. 196



FBLET012007



FBLET004007



FBLET005007



FBLET016007



PORTATA



RAL 5012



RAL 7016



RAL 7035



RAL 9005



ZINCATO

PERFOM

ARMADI CON PORTE A BATTENTE SERIE PRO

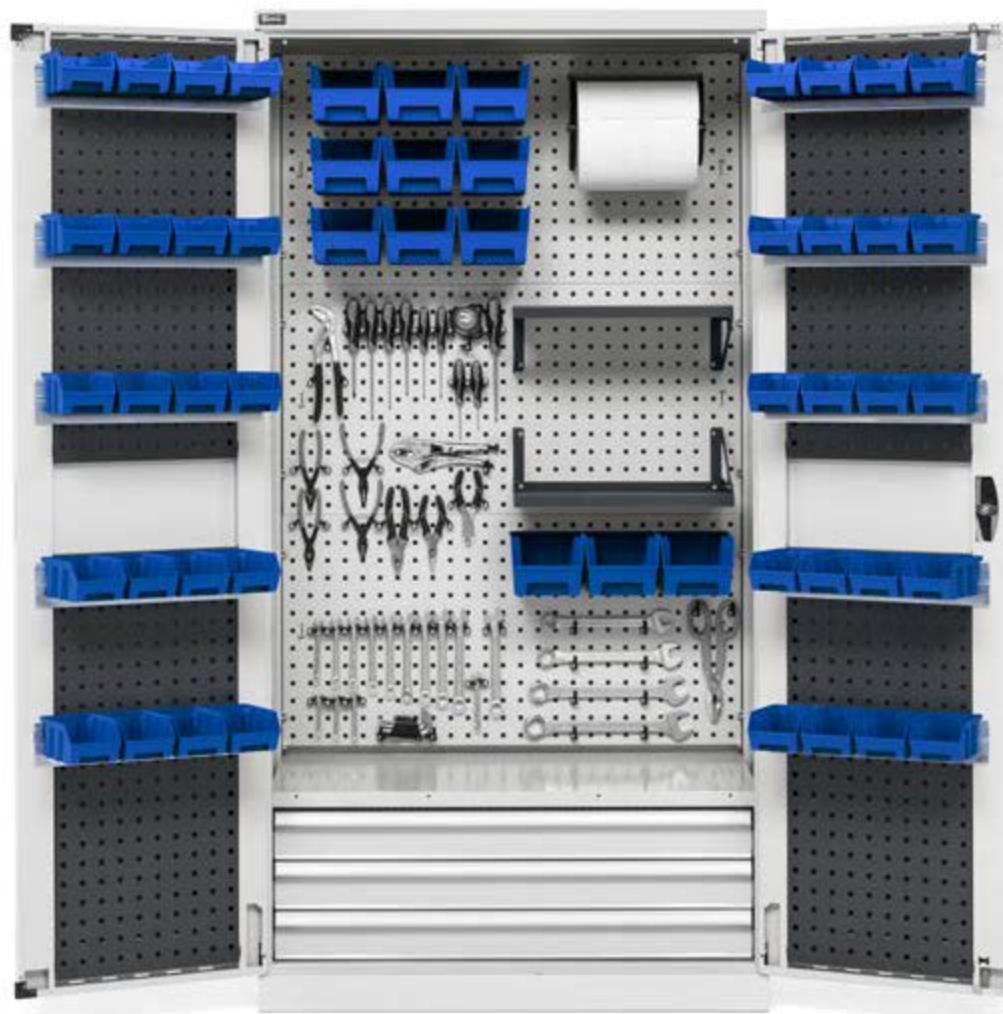

Gli armadi a porte a battente Perfom sono **soluzioni multiuso** che si adattano facilmente a numerosi ambienti e a diverse destinazioni d'uso. Infatti, grazie alla **vasta gamma di componenti** quali piani fessurati, pannelli forati, cassette, canalette e vasche stagne è possibile trasformare Perfom in armadi portautensili, per l'ecologia o per la ricarica. Sono disponibili in **tre diverse larghezze** (512, 1023 o 1193 mm) e **due altezze** (1000 o 2000 mm), tutti con **profondità 555 mm**. In base al modello scelto è possibile optare per **porte lisce, fessurate o fessurate in policarbonato**.

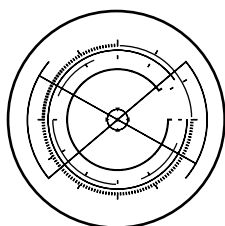

CONFIGURABILE



PORTATA 800/1200
KG

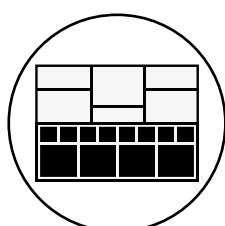

MATERIALE DI
SEPARAZIONE

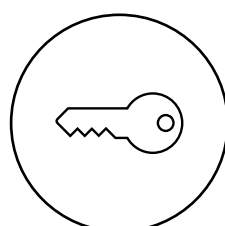

CHIUSURA A
CHIAVE

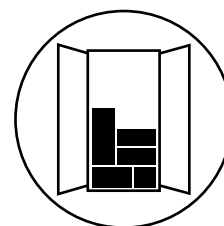

ARMADIO
MONTATO +
ACCESSORI
CONFEZIONATI
ALL'INTERNO



CONFIGURE

ART.	L mm	P mm	H mm	KG	RAL	€
PERFOM15001	1193	555	1000	800	7035+7016	485,70
PERFOM15002	1193	555	1000	800	7035	485,70
PERFOM15003	1193	555	1000	800	5012	485,70

Composto da:

qtà	descrizione
1	Armadio con porte a battente
1	Kit 2 piani fessurati



CONFIGURE

ART.	L mm	P mm	H mm	KG	RAL	€
PERFOM15004	1193	555	1000	800	7035+7016	612,90
PERFOM15005	1193	555	1000	800	7035	612,90
PERFOM15006	1193	555	1000	800	5012	612,90

Composto da:

qtà	descrizione
1	Armadio con porte a battente
1	Cassetto a estrazione telescopica H=100 mm
1	Kit 2 piani fessurati



CONFIGURE

ART.	L mm	P mm	H mm	KG	RAL	€
PERFOM15007	1193	555	1000	800	7035+7016	740,10
PERFOM15008	1193	555	1000	800	7035	740,10
PERFOM15009	1193	555	1000	800	5012	740,10

Composto da:

qtà	descrizione
1	Armadio con porte a battente
2	Cassetto a estrazione telescopica H=100 mm
1	Kit 2 piani fessurati



CONFIGURE

ART.	L mm	P mm	H mm	KG	RAL	€
PERFOM15010	1193	555	1000	800	7035+7016	838,50
PERFOM15011	1193	555	1000	800	7035	838,50
PERFOM15012	1193	555	1000	800	5012	838,50

Composto da:

qtà	descrizione
1	Armadio con porte a battente
3	Cassetto a estrazione telescopica H=100 mm
1	Piano fessurato



PORTATA



RAL 7035 + RAL 7016



RAL 5012



RAL 7035



24x27 EH

54x27 EH

64x27 EH

1193 mm 555 mm

1078x449



CONFIGURE

ART.	L mm	P mm	H mm	KG	RAL	€
PERFOM17001	1193	555	2000	1200	7035+7016	631,50
PERFOM17002	1193	555	2000	1200	7035	631,50
PERFOM17003	1193	555	2000	1200	5012	631,50

Composto da:

qtà	descrizione
1	Armadio con porte a battente
2	Kit 2 piani fessurati



CONFIGURE

ART.	L mm	P mm	H mm	KG	RAL	€
PERFOM17004	1193	555	2000	1200	7035+7016	1013,10
PERFOM17005	1193	555	2000	1200	7035	1013,10
PERFOM17006	1193	555	2000	1200	5012	1013,10

Composto da:

qtà	descrizione
1	Armadio con porte a battente
3	Cassetto a estrazione telescopica H=100 mm
2	Kit 2 piani fessurati



CONFIGURE

ART.	L mm	P mm	H mm	KG	RAL	€
PERFOM17007	1193	555	2000	1200	7035+7016	1717,20
PERFOM17008	1193	555	2000	1200	7035	1717,20
PERFOM17009	1193	555	2000	1200	5012	1717,20

Composto da:

qtà	descrizione
1	Armadio con porte a battente
9	Cassetto a estrazione telescopica H=100 mm
1	Kit 2 piani fessurati



CONFIGURE

ART.	L mm	P mm	H mm	KG	RAL	€
PERFOM11001	512	555	1000	800	7035+7016	272,70
FAA1120C00108	512	555	1000	800	7035	272,40
FAA1120C00104	512	555	1000	800	5012	272,40

Composto da:

qtà	descrizione
1	Armadio con porta a battente
1	Kit 2 piani fessurati



CONFIGURE

ART.	L mm	P mm	H mm	KG	RAL	€
PERFOM11004	512	555	1000	800	7035+7016	334,50
PERFOM11005	512	555	1000	800	7035	334,50
PERFOM11006	512	555	1000	800	5012	334,50

Composto da:

qtà	descrizione
1	Armadio con porta a battente
1	Cassetto a estrazione semplice H=100 mm
1	Kit 2 piani fessurati



CONFIGURE

ART.	L mm	P mm	H mm	KG	RAL	€
PERFOM11010	512	555	1000	800	1004	340,80
PERFOM11011	512	555	1000	800	7035+7016	340,80
PERFOM11012	512	555	1000	800	7035	340,80
PERFOM11013	512	555	1000	800	5012	340,80

Composto da:

qtà	descrizione
1	Armadio con porta a battente fessurata
1	Kit 2 vasche stagne interne di raccolta liquidi capacità 9 L



vedi pag. 364



CONFIGURE

ART.	L mm	P mm	H mm	KG set ruote	RAL	€
PERFOM11017	519	555	1409	225	7035+7016	541,50
PERFOM11018	519	555	1409	225	7035	531,00
PERFOM11019	519	555	1409	225	5012	531,00

Composto da:

qtà	descrizione
1	Armadio con porta a battente
1	Leggio
1	Cassetto a estrazione semplice H=100 mm
1	Kit 2 piani fessurati
1	Coppia piastre portaruote
1	Kit ruote in gomma standard Ø 100 mm





CONFIGURE

ART.	L mm	P mm	H mm	KG	RAL	€
PERFOM12001	1023	555	1000	800	7035+7016	394,20
FAA1220C00108	1023	555	1000	800	7035	393,90
FAA1220C00104	1023	555	1000	800	5012	393,90

Composto da:

qtà	descrizione
1	Armadio con porte a battente
1	Kit 2 piani fessurati



CONFIGURE

ART.	L mm	P mm	H mm	KG	RAL	€
PERFOM12004	1023	555	1000	800	7035+7016	467,40
PERFOM12005	1023	555	1000	800	7035	467,40
PERFOM12006	1023	555	1000	800	5012	467,40

Composto da:

qtà	descrizione
1	Armadio con porte a battente
1	Cassetto a estrazione semplice H=100 mm
1	Kit 2 piani fessurati



CONFIGURE

ART.	L mm	P mm	H mm	KG	RAL	€
PERFOM12007	1023	555	1000	800	7035+7016	590,10
PERFOM12008	1023	555	1000	800	7035	590,10
PERFOM12009	1023	555	1000	800	5012	590,10

Composto da:

qtà	descrizione
1	Armadio con porte a battente
3	Cassetto a estrazione semplice H=100 mm
1	Piano fessurato



CONFIGURE

ART.	L mm	P mm	H mm	KG	RAL	€
PERFOM12010	1023	555	1000	800	7035+7016	732,90
PERFOM12011	1023	555	1000	800	7035	732,90
PERFOM12012	1023	555	1000	800	5012	720,00

Composto da:

qtà	descrizione
1	Armadio con porte a battente fessurate
1	Kit 2 piani/pannelli forati
1	Canaletta elettrica per multiprese
2	Multipresa schuko a 2 scomparti
1	Multipresa schuko a 4 scomparti
1	Magnetotermico differenziale
1	Cavo di collegamento wieland schuko/francese





CONFIGURE

ART.	L mm	P mm	H mm	KG	RAL	€
PERFOM12013	1048	600	1027	800	1004	472,50
PERFOM12014	1048	600	1027	800	7035+7016	472,50
PERFOM12015	1048	600	1027	800	7035	472,50
PERFOM12016	1048	600	1027	800	5012	472,50

Composto da:

qtà	descrizione
1	Armadio con porte a battente fessurate
1	Piano fessurato
1	Vasca stagna esterna di raccolta liquidi capacità 59 L



vedi pag. 364



CONFIGURE

ART.	L mm	P mm	H mm	KG	RAL	€
PERFOM12017	1023	555	1000	800	1004	451,20
PERFOM12018	1023	555	1000	800	7035+7016	451,20
PERFOM12019	1023	555	1000	800	7035	451,20
PERFOM12020	1023	555	1000	800	5012	451,20

Composto da:

qtà	descrizione
1	Armadio con porte a battente fessurate
1	Kit 2 vasche stagne interne di raccolta liquidi capacità 19 L



vedi pag. 364



CONFIGURE

ART.	L mm	P mm	H mm	KG	RAL	€
PERFOM12025	1048	600	1027	800	6011	472,50

Composto da:

qtà	descrizione
1	Armadio con porte a battente fessurate
1	Piano fessurato
1	Vasca stagna esterna di raccolta liquidi capacità 59 L



vedi pag. 364



CONFIGURE

ART.	L mm	P mm	H mm	KG	RAL	€
PERFOM12021	1023	555	1000	800	3020	394,20
PERFOM12022	1023	555	1000	800	7035+7016	394,20
PERFOM12023	1023	555	1000	800	7035	394,20
PERFOM12024	1023	555	1000	800	5012	394,20

Composto da:

qtà	descrizione
1	Armadio con porte a battente fessurate
1	Kit 2 piani fessurati



PORTATA



RAL 7035 + RAL 7016



RAL 1004



RAL 3020



RAL 5012



RAL 6011



RAL 7035



CONFIGURE

ART.	L mm	P mm	H mm	KG	RAL	€
PERFOM14001	1023	555	2000	1200	7035+7016	520,50
FAA1420C00108	1023	555	2000	1200	7035	500,10
FAA1420C00104	1023	555	2000	1200	5012	500,10

Composto da:

qtà	descrizione
1	Armadio con porte a battente
1	Kit 4 piani fessurati



CONFIGURE

ART.	L mm	P mm	H mm	KG	RAL	€
PERFOM14004	1023	555	2000	1200	7035+7016	740,10
PERFOM14005	1023	555	2000	1200	7035	740,10
PERFOM14006	1023	555	2000	1200	5012	740,10

Composto da:

qtà	descrizione
1	Armadio con porte a battente
3	Cassetto a estrazione semplice H=100 mm
1	Kit 4 piani fessurati



CONFIGURE

ART.	L mm	P mm	H mm	KG	RAL	€
PERFOM14007	1023	555	2000	1200	7035+7016	650,10
PERFOM14008	1023	555	2000	1200	7035	650,10
PERFOM14009	1023	555	2000	1200	5012	650,10

Composto da:

qtà	descrizione
1	Armadio con porte a battente fessurate in policarbonato
1	Kit 4 piani fessurati



24x27 EH

54x27 EH

64x27 EH

1023 mm 555 mm

908x449



CONFIGURE

ART.	L mm	P mm	H mm	KG	RAL	€
PERFOM14019	1023	555	2000	1200	7035+7016	963,60
PERFOM14020	1023	555	2000	1200	7035	963,60
PERFOM14021	1023	555	2000	1200	5012	963,60

Composto da:

qtà	descrizione
1	Armadio con porte a battente fessurate
1	Vasca stagna interna di raccolta liquidi capacità 19 L
1	Kit piano fessurato con 2 separatori e 6 taniche con rubinetto a sfera
1	Kit 2 piani fessurati



CONFIGURE

ART.	L mm	P mm	H mm	KG	RAL	€
PERFOM14022	1048	600	2027	1200	7035+7016	1914,90
PERFOM14023	1048	600	2027	1200	7035	1914,90
PERFOM14024	1048	600	2027	1200	5012	1914,90

Composto da:

qtà	descrizione
1	Armadio con porte a battente fessurate
1	Vasca stagna interna di raccolta liquidi capacità 19 L
3	Kit piano fessurato con 2 separatori e 6 taniche con rubinetto a sfera
1	Piano fessurato
1	Vasca stagna esterna di raccolta liquidi capacità 59 L



PORTATA



RAL 7035 + RAL 7016



RAL 5012



RAL 7035



24x27 EH

54x27 EH

64x27 EH

1023 mm 555 mm

908x449



CONFIGURE

ART.	L mm	P mm	H mm	KG	RAL	€
PERFOM14056	1048	600	2027	1200	6011	599,40

Composto da:

qtà	descrizione
1	Armadio con porte a battente fessurate
1	Kit 3 piani fessurati
1	Vasca stagna esterna di raccolta liquidi capacità 59 L



vedi pag. 364



CONFIGURE

ART.	L mm	P mm	H mm	KG	RAL	€
PERFOM14057	1023	555	2000	1200	6011	636,60

Composto da:

qtà	descrizione
1	Armadio con porte a battente fessurate
2	Kit 2 vasche stagne interne di raccolta liquidi capacità 19 L



vedi pag. 364



CONFIGURE

ART.	L mm	P mm	H mm	KG	RAL	€
PERFOM14058	1023	555	2000	1200	7035	766,20

Composto da:

qtà	descrizione
1	Armadio con porte a battente fessurate in policarbonato
2	Kit 2 vasche stagne interne di raccolta liquidi capacità 19 L



vedi pag. 364



CONFIGURE

ART.	L mm	P mm	H mm	KG	RAL	€
PERFOM14025	1048	600	2027	1200	1004	599,40
PERFOM14026	1048	600	2027	1200	7035+7016	599,40
PERFOM14027	1048	600	2027	1200	7035	599,40
PERFOM14028	1048	600	2027	1200	5012	599,40

Composto da:

qtà	descrizione
1	Armadio con porte a battente fessurate
1	Kit 3 piani fessurati
1	Vasca stagna esterna di raccolta liquidi capacità 59 L



vedi pag. 364



CONFIGURE

ART.	L mm	P mm	H mm	KG	RAL	€
PERFOM14029	1023	555	2000	1200	1004	636,60
PERFOM14030	1023	555	2000	1200	7035+7016	636,60
PERFOM14031	1023	555	2000	1200	7035	636,60
PERFOM14032	1023	555	2000	1200	5012	636,60

Composto da:

qtà	descrizione
1	Armadio con porte a battente fessurate
2	Kit 2 vasche stagne interne di raccolta liquidi capacità 19 L



vedi pag. 364



CONFIGURE

ART.	L mm	P mm	H mm	RAL	€
PERFOM14033	1023	555	2000	3020	830,40

Composto da:

qtà	descrizione
1	Armadio con porte a battente fessurate safe crash
1	Kit 3 piani fessurati
1	Piano/pannello forato
1	Parete divisorio
1	Kit tubo appendiabiti



PORTATA



RAL 7035 + RAL 7016



RAL 1004



RAL 3020



RAL 5012



RAL 6011



RAL 7035



CONFIGURE



ART.	L mm	P mm	H mm	KG	RAL	€
PERFOM14034	1023	555	2000	1200	7035+7016	1314,00
PERFOM14035	1023	555	2000	1200	7035	1314,00
PERFOM14036	1023	555	2000	1200	5012	1288,20

Composto da:

qtà	descrizione	qtà	descrizione
1	Armadio con porte a battente fessurate	1	Magnetotermico differenziale
2	Kit 2 piani/pannelli forati	1	Cavo di collegamento wieland con spine in/out
2	Canaletta elettrica per multiprese	2	Cavo di collegamento wieland schuko/francese
1	Griglia per ventole	1	Kit porta rotolo con carta Ø=240 mm
2	Ventola 230 V senza griglia con spina Schuko	1	Gancio Unipok per utensili - confezione 30 pezzi
4	Multipresa schuko a 2 scomparti	2	Mensola grande reversibile
3	Multipresa schuko a 4 scomparti		



24x27 EH

54x27 EH

64x27 EH

1023 mm 555 mm

908x449



CONFIGURE

ART.	L mm	P mm	H mm	KG	RAL	€
PERFOM14037	1023	555	2000	1200	7035+7016	1303,20
PERFOM14038	1023	555	2000	1200	7035	1303,20
PERFOM14039	1023	555	2000	1200	5012	1277,40

Composto da:

qtà	descrizione
1	Armadio con porte a battente fessurate in policarbonato
2	Kit 2 piani/pannelli forati
3	Canaletta elettrica per multiprese
6	Multipresa schuko a 2 scomparti
3	Multipresa schuko a 4 scomparti
1	Magnetotermico differenziale
2	Cavo di collegamento wieland con spine in/out
1	Cavo di collegamento wieland schuko/francese



CONFIGURE

ART.	L mm	P mm	H mm	KG	RAL	€
PERFOM14040	1023	555	2000	1200	7035+7016	1205,10
PERFOM14041	1023	555	2000	1200	7035	1205,10
PERFOM14042	1023	555	2000	1200	5012	1179,30

Composto da:

qtà	descrizione
1	Armadio con porte a battente fessurate
2	Kit 2 piani/pannelli forati
2	Canaletta elettrica per multiprese
2	Barra aggancio per contenitori Picking Box mis. 1/2
2	Kit 3 contenitori Picking Box Air mis. 2
4	Multipresa schuko a 2 scomparti
2	Multipresa schuko a 4 scomparti
1	Magnetotermico differenziale
1	Cavo di collegamento wieland con spine in/out
1	Cavo di collegamento wieland schuko/francese
1	Kit porta rotolo con carta Ø=240 mm
2	Gancio Unipok per utensili - confezione 30 pezzi
2	Mensola grande reversibile



CONFIGURE

ART.	L mm	P mm	H mm	KG	RAL	€
PERFOM14043	1023	555	2000	1200	7035+7016	862,50
PERFOM14044	1023	555	2000	1200	7035	862,50
PERFOM14045	1023	555	2000	1200	5012	836,70

Composto da:

qtà	descrizione
1	Armadio con porte a battente fessurate
2	Kit 2 piani/pannelli forati
2	Canaletta elettrica per multiprese
2	Multipresa schuko a 2 scomparti
2	Multipresa schuko a 4 scomparti
1	Cavo di collegamento wieland con spine in/out
1	Cavo di collegamento wieland schuko/francese



PORTATA



RAL 7035 + RAL 7016



RAL 5012



RAL 7035



CONFIGURE



ART.	L mm	P mm	H mm	KG	RAL	€
PERFOM14049	1023	555	2000	1200	7035+7016	985,20
PERFOM14050	1023	555	2000	1200	7035	985,20
PERFOM14051	1023	555	2000	1200	5012	959,40

Composto da:

qtà	descrizione
1	Armadio con porte a battente
3	Cassetto a estrazione semplice H=100 mm
2	Kit 2 piani/pannelli forati
4	Barra aggancio per contenitori Picking Box mis. 1/2
4	Kit 3 contenitori Picking Box Air mis. 2
4	Gancio Unipok per utensili - confezione 30 pezzi



24x27 EH

54x27 EH

64x27 EH

1023 mm 555 mm

908x449



CONFIGURE

ART.	L mm	P mm	H mm	KG	RAL	€
PERFOM14052	1023	555	2000	1200	7035+7016	1143,00
PERFOM14053	1023	555	2000	1200	7035	1143,00
PERFOM14054	1023	555	2000	1200	5012	1143,00

Composto da:

qtà	descrizione
1	Armadio con porte a battente
3	Cassetto a estrazione semplice H=100 mm
4	Cassetto a estrazione telescopica H=150 mm
1	Kit 2 piani fessurati



CONFIGURE

ART.	L mm	P mm	H mm	KG	RAL	€
PERFOM14046	1023	555	2000	1200	7035+7016	1307,70
PERFOM14047	1023	555	2000	1200	7035	1307,70
PERFOM14048	1023	555	2000	1200	5012	1281,90

Composto da:

qtà	descrizione
1	Armadio con porte a battente
3	Cassetto a estrazione semplice H=100 mm
2	Coppia pannelli forati per porta a battente
2	Kit 2 piani/pannelli forati
14	Barra aggancio per contenitori Picking Box mis. 1/2
10	Kit 4 contenitori Picking Box Air mis. 1
4	Kit 3 contenitori Picking Box Air mis. 2
1	Kit porta rotolo con carta Ø=240 mm
4	Gancio Unipok per utensili - confezione 30 pezzi
2	Mensola grande reversibile



CONFIGURE

ART.	L mm	P mm	H mm	KG	RAL	€
PERFOM14010	1023	555	2000	1200	7035+7016	620,40
PERFOM14011	1023	555	2000	1200	7035	620,40
PERFOM14012	1023	555	2000	1200	5012	620,40

Composto da:

qtà	descrizione
1	Armadio con porte a battente fessurate
1	Kit 3 piani fessurati
1	Piano/pannello forato
1	Parete divisorio
1	Kit tubo appendiabiti



PORTATA



RAL 7035 + RAL 7016



RAL 5012







RAL 7035



CONFIGURE 





ARMADIO A PORTE A BATTENTE 24X27 EH

ART.	L mm	P mm	H mm	 KG	RAL	€
 FAA1120C000PD	512	555	1000	800	7035+7016	245,40
 FAA1120C00008	512	555	1000	800	7035	245,40
 FAA1120C00004	512	555	1000	800	5012	245,40



CONFIGURE 

ARMADIO A PORTE A BATTENTE 54X27 EH

ART.	L mm	P mm	H mm	 KG	RAL	€
 FAA1220C000PD	1023	555	1000	800	7035+7016	346,20
 FAA1220C00008	1023	555	1000	800	7035	346,20
 FAA1220C00004	1023	555	1000	800	5012	346,20



CONFIGURE 

ARMADIO A PORTE A BATTENTE 64X27 EH

ART.	L mm	P mm	H mm	 KG	RAL	€
 FAA1520C000PD	1193	555	1000	800	7035+7016	426,60
 FAA1520C00008	1193	555	1000	800	7035	426,60
 FAA1520C00004	1193	555	1000	800	5012	426,60

PERFOM

COMPONENTI



ARMADIO A PORTE A BATTENTE 64X27 EH

ART.	L mm	P mm	H mm	 KG	RAL	€
 FAA1720C000PD	1193	555	2000	1200	7035+7016	513,30
 FAA1720C00008	1193	555	2000	1200	7035	513,30
 FAA1720C00004	1193	555	2000	1200	5012	513,30

CONFIGURE 



ARMADIO A PORTE A BATTENTE 54X27 EH

ART.	L mm	P mm	H mm	 KG	RAL	€
 FAA1420C000PD	1023	555	2000	1200	7035+7016	426,60
 FAA1420C00008	1023	555	2000	1200	7035	426,60
 FAA1420C00004	1023	555	2000	1200	5012	426,60

CONFIGURE 



PORTATA



RAL 7035 + RAL 7016



RAL 5012



RAL 7035

COMPONENTI



CONFIGURE 

ARMADIO A PORTE A BATTENTE FESSURATE 24X27 EH

ART.	L mm	P mm	H mm	 KG	RAL	€
 FAA1130C000PD	512	555	1000	800	7035+7016	245,40
 FAA1130C00008	512	555	1000	800	7035	245,40
 FAA1130C00004	512	555	1000	800	5012	245,40
 FAA1130C00030	512	555	1000	800	1004	245,40



CONFIGURE 

ARMADIO A PORTE A BATTENTE FESSURATE 54X27 EH

ART.	L mm	P mm	H mm	 KG	RAL	€
 FAA1230C000PD	1023	555	1000	800	7035+7016	346,20
 FAA1230C00008	1023	555	1000	800	7035	346,20
 FAA1230C00004	1023	555	1000	800	5012	346,20
 FAA1230C00030	1023	555	1000	800	1004	346,20
 FAA1230C0002Y	1023	555	1000	800	3020	346,20
 FAA1230C00002	1023	555	1000	800	6011	346,20



CONFIGURE 

ARMADIO A PORTE A BATTENTE FESSURATE 54X27 EH

ART.	L mm	P mm	H mm	 KG	RAL	€
 FAA1430C000PD	1023	555	2000	1200	7035+7016	426,60
 FAA1430C00008	1023	555	2000	1200	7035	426,60
 FAA1430C00004	1023	555	2000	1200	5012	426,60
 FAA1430C00030	1023	555	2000	1200	1004	426,60
 FAA1430C00002	1023	555	2000	1200	6011	426,60



PERFOM

COMPONENTI



CONFIGURE

ARMADIO A PORTE A BATTENTE FESSURATE IN POLICARBONATO 54X27 EH

ART.	L mm	P mm	H mm		RAL	€
FAA1440C000PD	1023	555	2000	1200	7035+7016	556,20
FAA1440C00008	1023	555	2000	1200	7035	556,20
FAA1440C00004	1023	555	2000	1200	5012	556,20



CONFIGURE

ARMADIO A PORTE A BATTENTE FESSURATE SAFE CRASH 54X27 EH

ART.	L mm	P mm	H mm		RAL	€
FAA1440C05C2Y	1023	555	2000	1200	3020	636,60



- PORTATA
- RAL 7035 + RAL 7016
- RAL 1004
- RAL 3020
- RAL 5012
- RAL 6011
- RAL 7035



TOP A 3 BORDI RIVESTITI IN PVC

ART.	L mm	P mm	H mm	colore	€
FAC9911290007	514	558	31	Nero	54,30
FAC9912290007	1024	558	31	Nero	72,00
FAC9915290007	1194	558	31	Nero	73,20



TOP IN ACCIAIO GOMMATO

ART.	L mm	P mm	H mm	colore	€
FAC9911360007	512	555	32	Nero	129,90
FAC9912360007	1023	555	32	Nero	197,70
FAC9915360007	1193	555	32	Nero	207,00



PIANO FESSURATO P=500 mm

ART.	L mm	P mm	H mm	KG	finitura	€
FAC9911010099	484	500	35	120	Zincato	17,70
FAC9912010099	995	500	35	120	Zincato	24,30
FAC9915010099	1165	500	35	120	Zincato	30,30

KIT PIANI FESSURATI P=500 mm

ART.	L mm	P mm	H mm	n. piani	KG	finitura	€
FAC9911020099	484	500	35	2	120	Zincato	27,30
FAC9911030099	484	500	35	3	120	Zincato	39,90
FAC9912020099	995	500	35	2	120	Zincato	48,00
FAC9912030099	995	500	35	3	120	Zincato	70,80
FAC9912040099	995	500	35	4	120	Zincato	93,90
FAC9915020099	1165	500	35	2	120	Zincato	59,10
FAC9915030099	1165	500	35	3	120	Zincato	89,40



KIT PIANI FESSURATI P=345 mm

ART.	L mm	P mm	H mm	n. piani	KG	finitura	€
FAC9912050099	995	345	35	2	100	Zincato	48,00
FAC9912060099	995	345	35	3	100	Zincato	70,80



COPIA PANNELLI FORATI PER PORTA A BATTENTE

Si può applicare fino ad un massimo di una coppia pannelli per porta

ART.	L mm	P mm	H mm	Dim. foro mm	Passo mm	RAL	€
FAC9912250039	381	20	824	10x10	38	7016	61,20



COMPONENTI



KIT 4 CONTENITORI PICKING BOX AIR MIS. 1

ART.	dim. ingombro			colore	€
	L mm	P mm	H mm		
FBLIT0600LQ	108	173	76		5,70
FBLIT060039	108	173	76		5,70
FBLIT060032	108	173	76		5,70
FBLIT06001Z	108	173	76		5,70
FBLIT06002Y	108	173	76		5,70
FBLIT06004Q	108	173	76		5,70



KIT 3 CONTENITORI PICKING BOX AIR MIS. 2

ART.	dim. ingombro			colore	€
	L mm	P mm	H mm		
FBLIT0610LQ	160	234	127		8,10
FBLIT061039	160	234	127		8,10
FBLIT061032	160	234	127		8,10
FBLIT06101Z	160	234	127		8,10
FBLIT06102Y	160	234	127		8,10
FBLIT06104Q	160	234	127		8,10



BARRA AGGANCIO PER CONTENITORI PICKING BOX MIS. 1/2

ART.	L mm	P mm	H mm	finitura	€
FBLIT020099	445	14	89	Zincato	4,20



Esempio di applicazione del kit 4 contenitori mis. 1 su barra aggancio



Esempio di applicazione del kit 3 contenitori mis. 2 su barra aggancio

PIANO-PANNELLO FORATO

Applicabile in 3 diverse posizioni:

PIANO/PANNELLO FORATO

ART.	L mm	P mm	H mm	KG	Dim. foro mm	Passo mm	RAL	€
FAC9912070039	995	500	30	120-50	10x10	38	7016	61,20
FAC9912070008	995	500	30	120-50	10x10	38	7035	61,20
FAC9912070004	995	500	30	120-50	10x10	38	5012	55,50

Pannello forato verticale

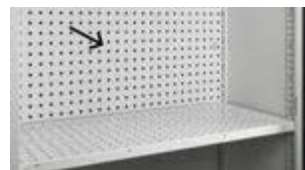

Piano orizzontale

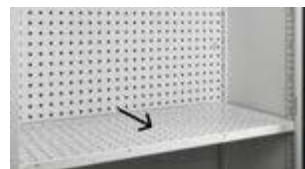

KIT PIANI-PANNELLI FORATI

ART.	L mm	P mm	H mm	n. piani	KG	Dim. foro mm	Passo mm	RAL	€
FAC9912080008	995	500	30	2	120-50	10x10	38	7035	117,90
FAC9912080004	995	500	30	2	120-50	10x10	38	5012	105,00
FAC9912080039	995	500	30	2	120-50	10x10	38	7016	117,90

Mensola forata a 4 bordi



PORTATA



RAL 5012



RAL 7016



RAL 7035



ZINCATO



CASSETTI AD ESTRAZIONE SEMPLICE 24X27 EH

ART.	dim. utili			KG		h frontale cassetto	RAL	€
	L mm	P mm	H mm					
FAC9911180008	398	449	85	50	88%	100	7035	61,80
FAC9911180004	398	449	85	50	88%	100	5012	61,80
FAC9911180039	398	449	85	50	88%	100	7016	72,30



CASSETTI AD ESTRAZIONE SEMPLICE 54X27 EH

ART.	dim. utili			KG		h frontale cassetto	RAL	€
	L mm	P mm	H mm					
FAC9912180008	908	449	85	50	88%	100	7035	73,20
FAC9912180004	908	449	85	50	88%	100	5012	73,20
FAC9912180039	908	449	85	50	88%	100	7016	90,90



CASSETTI AD ESTRAZIONE TELESCOPICA 54X27 EH

ART.	dim. utili			KG		h frontale cassetto	RAL	€
	L mm	P mm	H mm					
FAC9912190008	908	449	85	100	100%	100	7035	99,00
FAC9912190004	908	449	85	100	100%	100	5012	99,00
FAC9912190039	908	449	85	100	100%	100	7016	116,10
FAC9912210008	908	449	135	100	100%	150	7035	112,20
FAC9912210004	908	449	135	100	100%	150	5012	112,20
FAC9912210039	908	449	135	100	100%	150	7016	124,50



CASSETTI AD ESTRAZIONE TELESCOPICA 64X27 EH

ART.	dim. utili			KG		h frontale cassetto	RAL	€
	L mm	P mm	H mm					
FAC9915190008	1078	449	85	100	100%	100	7035	127,20
FAC9915190004	1078	449	85	100	100%	100	5012	127,20
FAC9915190039	1078	449	85	100	100%	100	7016	142,80

COMPONENTI



ZOCOLO PER TRANSPALLET COMPLETO DI CHIUSURA

ART.	L mm	P mm	H mm	KG	RAL	€
FAC9912170039	1018	550	100	1200	7016	146,40
FAC9915170039	1188	550	100	1200	7016	168,60



VASCA STAGNA ESTERNA DI RACCOLTA LIQUIDI CAPACITÀ 59 L

ART.	L mm	P mm	H mm	KG	L	RAL	€
FAC9912130039	1048	600	167	1200	59	7016	102,00



vedi pag. 364

VASCHE STAGNE INTERNE RACCOLTA LIQUIDI

ART.	L mm	P mm	H mm	KG	L	finitura	€
FAC9911090099	484	500	42	50	9	Zincato	48,00
FAC9912090099	995	500	42	50	19	Zincato	52,50



KIT VASCHE STAGNE INTERNE RACCOLTA LIQUIDI

ART.	L mm	P mm	H mm	KG	L	n. vasche	finitura	€
FAC9911100099	484	500	42	50	9	2	Zincato	95,40
FAC9912100099	995	500	42	50	19	2	Zincato	105,00



KIT PIANO FESSURATO CON 2 SEPARATORI E 6 TANICHE CON RUBINETTO A SFERA

ART.	L mm	P mm	H mm	n. taniche	L taniche	finitura piano	€
FAC9912280099	995	495	315	6	10	Zincato	436,50



PORTATA



CAPACITÀ



ESTRAZIONE



RAL 5012



RAL 7016



RAL 7035



ZINCATO

COMPONENTI



CANALETTA ELETTRICA PER MULTIPRESE

ART.	L mm	P mm	H mm	RAL	€
 FAC9912220039	1008	64	140	7016	33,90



SCHEMA MULTIPRESE PER CANALETTA ELETTRICA



- 1
- 2
- 3
- 3
- 4

- 1 magnetotermico
- 2 multipresa 4 scomparti
- 3 multipresa 2 scomparti
- 4 USB ricarica



Applicazione canaletta elettrica sulla **parte superiore** del **piano-pannello forato**



Applicazione canaletta elettrica sulla **parte inferiore** del **piano-pannello forato**



Canaletta elettrica **integrabile** con **piano-pannello forato** in posizione verticale



SUPPORTO LATERALE PER MULTIPRESE

ART.	L mm	P mm	H mm	RAL	€
 FAC9912240039	10	463	77	7016	19,20

SCHEMA MULTIPRESE PER SUPPORTO LATERALE



multipresa 4 scomparti



Esempio di applicazione con:
 1 supporto art. FAC9912240039
 1 multipresa art. FBLET005007
 1 cavo di collegamento art. FBLET016007

COMPONENTI



GRIGLIA PER VENTOLE

ART.	L mm	P mm	H mm	RAL	€
 FAC9912230039	994	123	136	7016	40,20

Esempio di applicazione con:
 1 griglia art. FAC9912230039
 2 ventole art. FAS32200100
 1 multipresa art. FBLET005007
 1 cavo di collegamento art. FBLET016007



Applicazione griglia nella **parte superiore** dell'armadio **senza** l'ausilio del **piano-pannello forato**



Applicazione griglia nella **parte superiore** dell'armadio **con** l'ausilio del **piano-pannello forato**



Applicazione griglia nella **parte inferiore** dell'armadio **con** l'ausilio del **piano-pannello forato**



VENTOLA 230 V SENZA GRIGLIA CON SPINA SCHUKO

ART.	L mm	P mm	H mm	colore	€
 FAS32200100	125	44	125	Nero	30,90

IRONTEAM

vedi pag. 196



FBLET012007



FBLET004007



FBLET005007



FBLET016007



FBLET014007



FBLET020007



FBL99400008

APPLICAZIONE DELLA LAMPADA SOTTO IL PIANO-PANNELLO FORATO



COMPONENTI



1. Leggio
2. Cassetto a estrazione semplice H=100 mm
3. Coppia piastre portaruote
4. Kit ruote in gomma standard Ø 100 mm



LEGGIO

ART.	L mm	P mm	H mm	RAL	€
FAC9911340004	516	564	316	5012	123,00
FAC9911340008	516	564	316	7035	123,00
FAC9911340039	516	564	316	7016	123,00



CASSETTI AD ESTRAZIONE SEMPLICE 24X27 EH

ART.	dim. utili			KG	%	h frontale cassetto	RAL	€
	L mm	P mm	H mm					
FAC9911180008	398	449	85	50	88%	100	7035	61,80
FAC9911180004	398	449	85	50	88%	100	5012	61,80
FAC9911180039	398	449	85	50	88%	100	7016	72,30



PARETE DI CHIUSURA ANTERIORE PER LEGGIO

ART.	L mm	P mm	H mm	RAL	€
FAC9911350004	454	60	101	5012	16,50
FAC9911350008	454	60	101	7035	16,50
FAC9911350039	454	60	101	7016	16,50



COPPIA PIASTRE PORTARUOTE

ART.	L mm	P mm	H mm	€
FAC9911330099	114	550	13	29,40



KIT RUOTE

ART.	Ø mm	KG set ruote	H mm	materiale			€
FKRD1002107	100	225	128	Gomma standard	2	2	44,10
FKRB1252107	125	300	155	Gomma standard	2	2	48,90
FKRU1252101	125	300	155	Gomma antitraccia sintetica	2	2	53,40
FKRS1252101	125	750	155	Gomma elastica	2	2	85,20



RUOTA GIREVOLE CON FRENO



RUOTA FISSA

COMPONENTI

1. Parete divisorio
2. Kit tubo appendiabiti
3. Piano/pannello forato
4. Piano fessurato
5. Cassetto a estrazione semplice H=100 mm

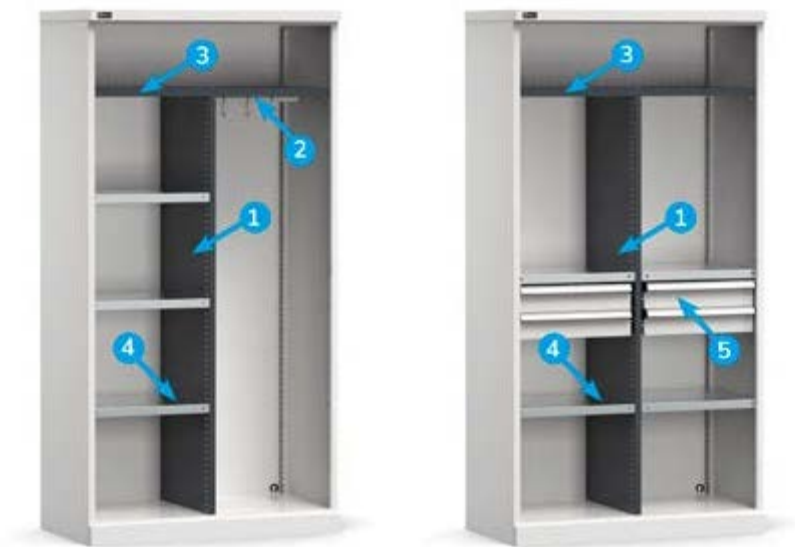

PARETE DIVISORIO

ART.	L mm	P mm	H mm	Passo mm	RAL	€
FAC9912260039	44	500	1616	25	7016	81,60

KIT TUBO APPENDIABITI

ART.	L mm	P mm	H mm	KG	finitura	€
FAC9912270099	458	23	56	15	Zincato	11,10

PIANO/PANNELLO FORATO

ART.	L mm	P mm	H mm	KG	RAL	€
FAC9912070039	995	500	30	120-50	7016	61,20

PIANO FESSURATO P=500 mm

ART.	L mm	P mm	H mm	KG	finitura	€
FAC9911010099	484	500	35	120	Zincato	17,70

KIT PIANI FESSURATI P=500 mm

ART.	L mm	P mm	H mm	n. piani	KG	finitura	€
FAC9911020099	484	500	35	2	120	Zincato	27,30
FAC9911030099	484	500	35	3	120	Zincato	39,90

CASSETTI AD ESTRAZIONE SEMPLICE 24X27 EH

ART.	dim. utili			KG		h frontale cassetto	RAL	€
	L mm	P mm	H mm					
FAC9911180008	398	449	85	50	88%	100	7035	61,80
FAC9911180004	398	449	85	50	88%	100	5012	61,80
FAC9911180039	398	449	85	50	88%	100	7016	72,30

L 512 mm



ART.	adatto per cassetto H mm	componenti	€
 FFH00500100	100	2 x Divisorio trasversale L=202 mm 1 x Divisorio longitudinale fessurato L=457 mm	7,50





ART.	adatto per cassetto H mm	componenti	€
 FFH00500800	100/125	3 x Cassetta divisorio 150x75 mm 6 x Cassetta divisorio 150x150 mm	20,70

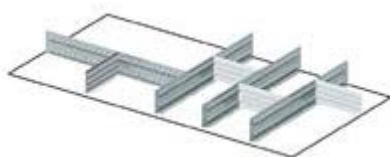

ART.	adatto per cassetto H mm	componenti	€
 FFH00500900	100/125	15 x Cassetta divisorio 150x75 mm	25,20

L 1023 mm



ART.	adatto per cassetto H mm	componenti	€
 FFH02000100	100	4 x Divisorio longitudinale fessurato L=457 mm 4 x Divisorio trasversale L=151 mm	23,10



ART.	adatto per cassetto H mm	componenti	€
 FFH02000200	100	5 x Divisorio longitudinale fessurato L=457 mm 10 x Divisorio trasversale L=151 mm	35,40



ART.	adatto per cassetto H mm	componenti	€
 FFH02000600	100/125	12 x Cassetta divisorio 150x75 mm 12 x Cassetta divisorio 150x150 mm	49,50



MATERIALE DI SEPARAZIONE

L → 1193 mm

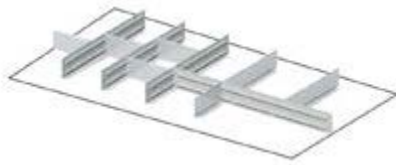

ART.	adatto per cassetto H mm	componenti	€
FFH02500300	100	3 x Divisorio longitudinale fessurato L=457 mm 1 x Divisorio longitudinale fessurato L=610 mm 3 x Divisorio trasversale L=151 mm 2 x Divisorio trasversale L=168 mm 2 x Divisorio trasversale L=304 mm	29,70



ART.	adatto per cassetto H mm	componenti	€
FFH02500400	100	3 x Divisorio longitudinale fessurato L=457 mm 1 x Divisorio trasversale L=168 mm 3 x Divisorio trasversale L=304 mm	21,00

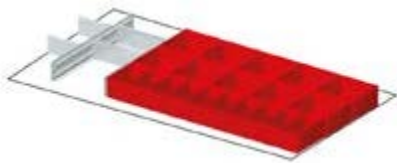

ART.	adatto per cassetto H mm	componenti	€
FFH02500600	100	10 x Cassetta divisorio 150x75 mm 10 x Cassetta divisorio 150x150 mm 2 x Divisorio longitudinale fessurato L=457 mm 2 x Divisorio trasversale L=134 mm 2 x Divisorio trasversale L=202 mm	50,10

PERFOM

ARMADI CON PORTE SCORREVOLI SERIE PRO



L'armadio a porte scorrevoli Perfom è perfetto per essere installato in aree di passaggio o se si cerca un **arredo salvaspazio** con un'elevata capacità di stoccaggio. Può presentare **tre larghezze** (1020, 1428 o 2040 mm) e **due altezze** (915 o 2000 mm) e **porte lisce, fessurate o fessurate in policarbonato**. Indipendentemente dal modello scelto, la **profondità** è di **600 mm** e può ospitare una vasta gamma di componenti come piani fessurati, pannelli forati, cassetti, vasche stagne e canalette elettriche.



PORTATA 800/1200
KG



GARANZIA PORTE

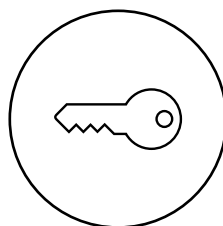

CHIUSURA A
CHIAVE

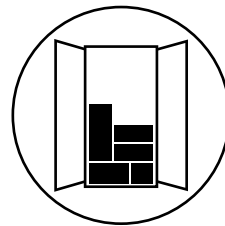

ARMADIO
MONTATO +
ACCESSORI
CONFEZIONATI
ALL'INTERNO





ART.	L mm	P mm	H mm	KG	RAL	€
PERFOM21001	1020	600	2000	1200	7035+7016	855,90
PERFOM21002	1020	600	2000	1200	7035	855,90
PERFOM21003	1020	600	2000	1200	5012	855,90

Composto da:

qtà	descrizione
1	Armadio con porte scorrevoli
1	Kit 4 piani fessurati

[CONFIGURE](#)



ART.	L mm	P mm	H mm	KG	RAL	€
PERFOM23001	1020	600	2000	1200	7035+7016	972,00

Composto da:

qtà	descrizione	
1	Armadio con porte scorrevoli fessurate	
2	Kit 2 vasche stagne interne di raccolta liquidi capacità 19 L	vedi pag. 364

[CONFIGURE](#)



ART.	L mm	P mm	H mm	KG	RAL	€
PERFOM25001	1020	600	2000	1200	7035+7016	1049,10

Composto da:

qtà	descrizione
1	Armadio con porte scorrevoli fessurate in policarbonato
1	Kit 4 piani fessurati

[CONFIGURE](#)





ART.	L mm	P mm	H mm	 KG	RAL	€
 PERFOM20001	1020	600	915	800	7035+7016	607,20
 PERFOM20002	1020	600	915	800	7035	607,20
 PERFOM20003	1020	600	915	800	5012	607,20



Composto da:

qtà	descrizione
1	Armadio con porte scorrevoli
1	Piano fessurato



[CONFIGURE](#) 

ART.	L mm	P mm	H mm	 KG	RAL	€
 PERFOM22001	1020	600	915	800	7035+7016	687,90

Composto da:

qtà	descrizione		
1	Armadio con porte scorrevoli fessurate		
1	Kit 2 vasche stagne interne di raccolta liquidi capacità 19 L		vedi pag. 364

[CONFIGURE](#) 

ART.	L mm	P mm	H mm	 KG	RAL	€
 PERFOM24001	1020	600	915	800	7035+7016	744,00

Composto da:

qtà	descrizione
1	Armadio con porte scorrevoli fessurate in policarbonato
1	Piano fessurato

[CONFIGURE](#) 





ART.	L mm	P mm	H mm	KG	RAL	€
 PERFOM21004	1428	600	2000	1200	7035+7016	1113,60
 PERFOM21005	1428	600	2000	1200	7035	1113,60
 PERFOM21006	1428	600	2000	1200	5012	1113,60

Composto da:

qtà	descrizione
1	Armadio con porte scorrevoli
2	Kit 2 piani fessurati

[CONFIGURE](#) 



ART.	L mm	P mm	H mm	KG	RAL	€
 PERFOM25002	1428	600	2000	1200	7035+7016	1426,80

Composto da:

qtà	descrizione
1	Armadio con porte scorrevoli fessurate in policarbonato
2	Kit 2 piani fessurati

[CONFIGURE](#) 





ART.	L mm	P mm	H mm	KG	RAL	€
PERFOM20004	1428	600	915	800	7035+7016	764,70
PERFOM20005	1428	600	915	800	7035	764,70
PERFOM20006	1428	600	915	800	5012	764,70

Composto da:

qtà	descrizione
1	Armadio con porte scorrevoli
1	Piano fessurato

[CONFIGURE](#)



ART.	L mm	P mm	H mm	KG	RAL	€
PERFOM24002	1428	600	915	800	7035+7016	896,10

Composto da:

qtà	descrizione
1	Armadio con porte scorrevoli fessurate in policarbonato
1	Piano fessurato

[CONFIGURE](#)



PORTATA



RAL 7035 + RAL 7016



RAL 5012



RAL 7035



ART.	L mm	P mm	H mm	per vano	RAL	€
PERFOM21010	2040	600	2000	1200	7035+7016	1889,10
PERFOM21011	2040	600	2000	1200	7035	1889,10
PERFOM21012	2040	600	2000	1200	5012	1889,10

Composto da:

qtà	descrizione
1	Armadio con porte scorrevoli
6	Cassetto a estrazione semplice H=100 mm
2	Kit 4 piani fessurati

[CONFIGURE](#)



ART.	L mm	P mm	H mm	per vano	RAL	€
PERFOM23004	2040	600	2000	1200	7035+7016	2121,60

Composto da:

qtà	descrizione
1	Armadio con porte scorrevoli fessurate
3	Kit 2 piani/pannelli forati
1	Piano fessurato
1	Piano interno in multiplex
1	Cassetto a estrazione semplice H=100 mm
2	Canaletta elettrica per multiprese
1	Supporto laterale per multipresa
3	Multipresa schuko a 4 scomparti
4	Multipresa schuko a 2 scomparti
2	Cavo di collegamento wieland schuko/francese
1	Cavo di collegamento wieland con spine in/out
1	Coppia squadrette a L
1	Snodo per piastra
1	Piastra porta monitor con standard VESA
1	Mensola porta oggetti reversibile



[CONFIGURE](#)



ART.	L mm	P mm	H mm	per vano	RAL	€
PERFOM25004	2040	600	2000	1200	7035+7016	2098,20

Composto da:

qtà	descrizione		
1	Armadio con porte scorrevoli fessurate in policarbonato		
4	Kit 2 vasche stagne interne di raccolta liquidi capacità 19 L		

vedi pag. 364

[CONFIGURE](#)



ART.	L mm	P mm	H mm	per vano	RAL	€
PERFOM21007	2040	600	2000	1200	7035+7016	1449,90
PERFOM21008	2040	600	2000	1200	7035	1449,90
PERFOM21009	2040	600	2000	1200	5012	1449,90

Composto da:

qtà	descrizione
1	Armadio con porte scorrevoli
2	Kit 4 piani fessurati

[CONFIGURE](#)



ART.	L mm	P mm	H mm	per vano	RAL	€
PERFOM23003	2040	600	2000	1200	7035+7016	1682,10

Composto da:

qtà	descrizione		
1	Armadio con porte scorrevoli fessurate		
4	Kit 2 vasche stagne interne di raccolta liquidi capacità 19 L	vedi pag. 364	

[CONFIGURE](#)



ART.	L mm	P mm	H mm	per vano	RAL	€
PERFOM25003	2040	600	2000	1200	7035+7016	1866,00



Composto da:

qtà	descrizione
1	Armadio con porte scorrevoli fessurate in policarbonato
2	Kit 4 piani fessurati

[CONFIGURE](#)





ART.	L mm	P mm	H mm	KG per vano	RAL	€
 PERFOM20007	2040	600	915	800	7035+7016	998,70
 PERFOM20008	2040	600	915	800	7035	998,70
 PERFOM20009	2040	600	915	800	5012	998,70

Composto da:

qtà	descrizione
1	Armadio con porte scorrevoli
2	Piano fessurato

[CONFIGURE](#) 



ART.	L mm	P mm	H mm	KG per vano	RAL	€
 PERFOM22002	2040	600	915	800	7035+7016	1160,10

Composto da:

qtà	descrizione
1	Armadio con porte scorrevoli fessurate
2	Kit 2 vasche stagne interne di raccolta liquidi capacità 19 L



vedi pag. 364

[CONFIGURE](#) 



ART.	L mm	P mm	H mm	KG per vano	RAL	€
 PERFOM24003	2040	600	915	800	7035+7016	1181,10

Composto da:

qtà	descrizione
1	Armadio con porte scorrevoli fessurate in policarbonato
2	Piano fessurato

[CONFIGURE](#) 



ARMADIO CON PORTE SCORREVOLI 54X27 EH

ART.	L mm	P mm	H mm	KG	RAL	€
  FAA2010C000PD	1020	600	915	800	7035+7016	582,90
 FAA2010C00008	1020	600	915	800	7035	582,90
 FAA2010C00004	1020	600	915	800	5012	582,90



ARMADIO CON PORTE SCORREVOLI 78X27 EH

ART.	L mm	P mm	H mm	KG	RAL	€
  FAA2014C000PD	1428	600	915	800	7035+7016	722,40
 FAA2014C00008	1428	600	915	800	7035	722,40
 FAA2014C00004	1428	600	915	800	5012	722,40



ARMADIO CON PORTE SCORREVOLI 54+54X27 EH

ART.	L mm	P mm	H mm	KG per vano	RAL	€
  FAA2020C000PD	2040	600	915	800	7035+7016	950,10
 FAA2020C00008	2040	600	915	800	7035	950,10
 FAA2020C00004	2040	600	915	800	5012	950,10



ARMADIO CON PORTE SCORREVOLI 54X27 EH

ART.	L mm	P mm	H mm	KG	RAL	€
  FAA2110C000PD	1020	600	2000	1200	7035+7016	762,00
 FAA2110C00008	1020	600	2000	1200	7035	762,00
 FAA2110C00004	1020	600	2000	1200	5012	762,00



ARMADIO CON PORTE SCORREVOLI 78X27 EH

ART.	L mm	P mm	H mm	KG	RAL	€
  FAA2114C000PD	1428	600	2000	1200	7035+7016	954,00
 FAA2114C00008	1428	600	2000	1200	7035	954,00
 FAA2114C00004	1428	600	2000	1200	5012	954,00



ARMADIO CON PORTE SCORREVOLI 54+54X27 EH

ART.	L mm	P mm	H mm	KG per vano	RAL	€
  FAA2120C000PD	2040	600	2000	1200	7035+7016	1262,10
 FAA2120C00008	2040	600	2000	1200	7035	1262,10
 FAA2120C00004	2040	600	2000	1200	5012	1262,10



PORTATA



RAL 7035 + RAL 7016



RAL 5012



RAL 7035



ARMADIO CON PORTE SCORREVOLI FESSURATE 54X27 EH

ART.	L mm	P mm	H mm	KG	RAL	€
FAA2210C000PD	1020	600	915	800	7035+7016	582,90



ARMADIO CON PORTE SCORREVOLI FESSURATE 78X27 EH

ART.	L mm	P mm	H mm	KG	RAL	€
FAA2214C000PD	1428	600	915	800	7035+7016	722,40



ARMADIO CON PORTE SCORREVOLI FESSURATE 54+54X27 EH

ART.	L mm	P mm	H mm	KG per vano	RAL	€
FAA2220C000PD	2040	600	915	800	7035+7016	950,10



ARMADIO CON PORTE SCORREVOLI FESSURATE 54X27 EH

ART.	L mm	P mm	H mm	KG	RAL	€
FAA2310C000PD	1020	600	2000	1200	7035+7016	762,00



ARMADIO CON PORTE SCORREVOLI FESSURATE 78X27 EH

ART.	L mm	P mm	H mm	KG	RAL	€
FAA2314C000PD	1428	600	2000	1200	7035+7016	954,00



ARMADIO CON PORTE SCORREVOLI FESSURATE 54+54X27 EH

ART.	L mm	P mm	H mm	KG per vano	RAL	€
FAA2320C000PD	2040	600	2000	1200	7035+7016	1262,10



ARMADIO CON PORTE SCORREVOLI FESSURATE IN POLICARBONATO 54X27 EH



ART.	L mm	P mm	H mm	KG	RAL	€
FAA2410C000PD	1020	600	915	800	7035+7016	719,70



ARMADIO CON PORTE SCORREVOLI FESSURATE IN POLICARBONATO 78X27 EH



ART.	L mm	P mm	H mm	KG	RAL	€
FAA2414C000PD	1428	600	915	800	7035+7016	853,80



ARMADIO CON PORTE SCORREVOLI FESSURATE IN POLICARBONATO 54+54X27 EH



ART.	L mm	P mm	H mm	KG per vano	RAL	€
FAA2420C000PD	2040	600	915	800	7035+7016	1132,50



ARMADIO CON PORTE SCORREVOLI FESSURATE IN POLICARBONATO 54X27 EH



ART.	L mm	P mm	H mm	KG	RAL	€
FAA2510C000PD	1020	600	2000	1200	7035+7016	955,20



ARMADIO CON PORTE SCORREVOLI FESSURATE IN POLICARBONATO 78X27 EH



ART.	L mm	P mm	H mm	KG	RAL	€
FAA2514C000PD	1428	600	2000	1200	7035+7016	1267,20



ARMADIO CON PORTE SCORREVOLI FESSURATE IN POLICARBONATO 54+54X27 EH



ART.	L mm	P mm	H mm	KG per vano	RAL	€
FAA2520C000PD	2040	600	2000	1200	7035+7016	1678,20



PORTATA

RAL 7035 + RAL 7016



TOP IN ACCIAIO INOX SATINATO

ART.	L mm	P mm	H mm	materiale	finitura	€
FGG601006AX000A	1020	600	32	MDF	Inox satinato	227,70
FGG601406AX000A	1428	600	32	MDF	Inox satinato	290,10
FGG602006AX000A	2040	600	32	MDF	Inox satinato	385,20



TOP IN ACCIAIO GOMMATO

ART.	L mm	P mm	H mm	materiale	finitura	€
FGG601006AG0007	1020	600	32	MDF	Acciaio gommato	211,80
FGG601406AG0007	1428	600	32	MDF	Acciaio gommato	256,80
FGG602006AG0007	2040	600	32	MDF	Acciaio gommato	351,90



TOP IN MULTIPLEX

ART.	L mm	P mm	H mm	materiale	€
FGG601006BE0000	1020	600	30	Multiplex	119,40
FGG601406BE0000	1428	600	30	Multiplex	108,30
FGG602006BE0000	2040	600	30	Multiplex	143,40



PIANO FESSURATO P=500 mm

ART.	L mm	P mm	H mm	KG	finitura	€
FAC9912010099	995	500	35	120	Zincato	24,30
FAC9814010099	1403	500	35	100	Zincato	42,30



KIT PIANI FESSURATI P=500 mm

ART.	L mm	P mm	H mm	n. piani	KG	finitura	€
FAC9912020099	995	500	35	2	120	Zincato	48,00
FAC9912030099	995	500	35	3	120	Zincato	70,80
FAC9912040099	995	500	35	4	120	Zincato	93,90
FAC9814020099	1403	500	35	2	100	Zincato	79,80



COMPONENTI

PIANO/PANNELLO FORATO

Applicabile in 3 diverse posizioni:

Pannello forato verticale

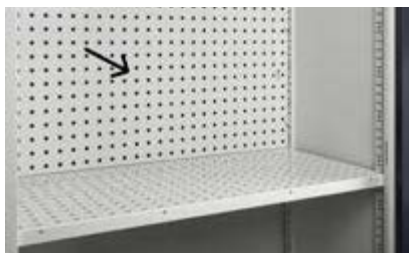

Piano orizzontale



Mensola forata a 4 bordi



PIANO/PANNELLO FORATO

ART.	L mm	P mm	H mm	KG	Dim. foro mm	Passo mm	RAL	€
FAC9912070039	995	500	30	120-50	10x10	38	7016	61,20
FAC9912070008	995	500	30	120-50	10x10	38	7035	61,20
FAC9912070004	995	500	30	120-50	10x10	38	5012	55,50

KIT PIANI-PANNELLI FORATI

ART.	L mm	P mm	H mm	n. piani	KG	Dim. foro mm	Passo mm	RAL	€
FAC9912080008	995	500	30	2	120-50	10x10	38	7035	117,90
FAC9912080004	995	500	30	2	120-50	10x10	38	5012	105,00
FAC9912080039	995	500	30	2	120-50	10x10	38	7016	117,90

CASSETTI AD ESTRAZIONE SEMPLICE 54X27 EH



ART.	dim. utili			KG		h frontale cassetto	RAL	€
	L mm	P mm	H mm					
FAC9912180008	908	449	85	50	88%	100	7035	73,20
FAC9912180004	908	449	85	50	88%	100	5012	73,20
FAC9912180039	908	449	85	50	88%	100	7016	90,90

CASSETTI AD ESTRAZIONE TELESCOPICA 54X27 EH



ART.	dim. utili			KG		h frontale cassetto	RAL	€
	L mm	P mm	H mm					
FAC9912190008	908	449	85	100	100%	100	7035	99,00
FAC9912190004	908	449	85	100	100%	100	5012	99,00
FAC9912190039	908	449	85	100	100%	100	7016	116,10
FAC9912210008	908	449	135	100	100%	150	7035	112,20
FAC9912210004	908	449	135	100	100%	150	5012	112,20
FAC9912210039	908	449	135	100	100%	150	7016	124,50



PORTATA



ESTRAZIONE



RAL 5012



RAL 7016



RAL 7035



ZINCATO



INOX SATINATO

COMPONENTI



VASCHE STAGNE INTERNE RACCOLTA LIQUIDI

ART.	L mm	P mm	H mm	KG	L	finitura	€
FAC9911090099	484	500	42	50	9	Zincato	48,00
FAC9912090099	995	500	42	50	19	Zincato	52,50

KIT VASCHE STAGNE INTERNE RACCOLTA LIQUIDI

ART.	L mm	P mm	H mm	KG	L	n. vasche	finitura	€
FAC9911100099	484	500	42	50	9	2	Zincato	95,40
FAC9912100099	995	500	42	50	19	2	Zincato	105,00



CANALETTA ELETTRICA PER MULTIPRESE

ART.	L mm	P mm	H mm	RAL	€
FAC9912220039	1008	64	140	7016	33,90



SCHEMA MULTIPRESE PER CANALETTA ELETTRICA



- 1
- 2
- 3
- 3
- 4

- 1 magnetotermico
- 2 multipresa 4 scomparti
- 3 multipresa 2 scomparti
- 4 USB ricarica



Applicazione canaletta elettrica sulla **parte superiore** del **piano-pannello forato**



Applicazione canaletta elettrica sulla **parte inferiore** del **piano-pannello forato**



Canaletta elettrica **integrabile** con **piano-pannello forato** in posizione verticale



SUPPORTO LATERALE PER MULTIPRESE

ART.	L mm	P mm	H mm	RAL	€
FAC9912240039	10	463	77	7016	19,20

SCHEMA MULTIPRESE PER SUPPORTO LATERALE



multipresa 4 scomparti



Esempio di applicazione con:
 1 supporto art. FAC9912240039
 1 multipresa art. FBLET005007
 1 cavo di collegamento art. FBLET016007

COMPONENTI



GRIGLIA PER VENTOLE

ART.	L mm	P mm	H mm	RAL	€
 FAC9912230039	994	123	136	7016	40,20

Esempio di applicazione con:
 1 griglia art. FAC9912230039
 2 ventole art. FAS32200100
 1 multipresa art. FBLET005007
 1 cavo di collegamento art. FBLET016007



Applicazione griglia nella **parte superiore** dell'armadio **senza** l'ausilio del **piano-pannello forato**



Applicazione griglia nella **parte superiore** dell'armadio **con** l'ausilio del **piano-pannello forato**



Applicazione griglia nella **parte inferiore** dell'armadio **con** l'ausilio del **piano-pannello forato**



VENTOLA 230 V SENZA GRIGLIA CON SPINA SCHUKO

ART.	L mm	P mm	H mm	colore	€
 FAS32200100	125	44	125	Nero	30,90

IRONTEAM

vedi pag. 196



FBLET012007



FBLET004007



FBLET005007



FBLET016007



FBLET014007



FBLET020007



FBL99400008

APPLICAZIONE DELLA LAMPADA SOTTO IL PIANO-PANNELLO FORATO



PORTATA



CAPACITÀ



RAL 7016



ZINCATO

COMPONENTI

1. Parete divisorio
2. Kit tubo appendiabiti
3. Piano/pannello forato
4. Piano fessurato
5. Cassetto a estrazione semplice H=100 mm

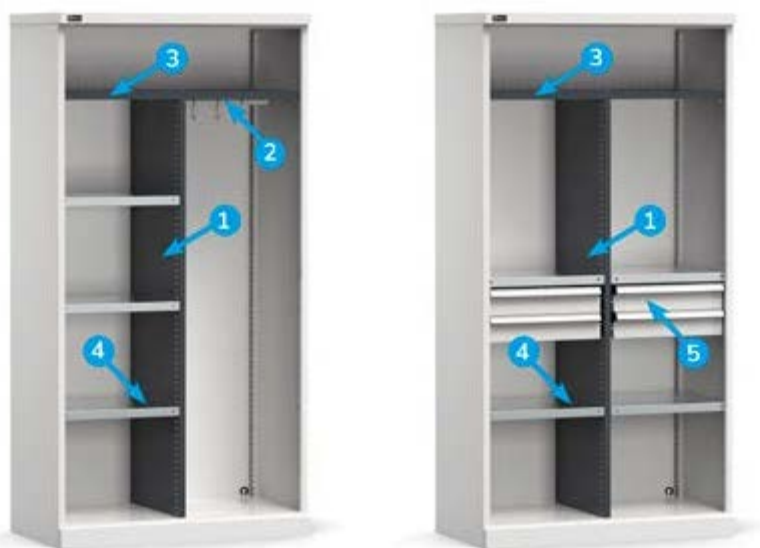

PARETE DIVISORIO

ART.	L mm	P mm	H mm	Passo mm	RAL	€
FAC9912260039	44	500	1616	25	7016	81,60

KIT TUBO APPENDIABITI

ART.	L mm	P mm	H mm	KG	finitura	€
FAC9912270099	458	23	56	15	Zincato	11,10

PIANO/PANNELLO FORATO

ART.	L mm	P mm	H mm	KG	RAL	€
FAC9912070039	995	500	30	120-50	7016	61,20

PIANO FESSURATO P=500 mm

ART.	L mm	P mm	H mm	KG	finitura	€
FAC9911010099	484	500	35	120	Zincato	17,70

KIT PIANI FESSURATI P=500 mm

ART.	L mm	P mm	H mm	n. piani	KG	finitura	€
FAC9911020099	484	500	35	2	120	Zincato	27,30
FAC9911030099	484	500	35	3	120	Zincato	39,90

CASSETTI A ESTRAZIONE SEMPLICE 24X27 EH

ART.	dim. utili			KG		h frontale cassetto	RAL	€
	L mm	P mm	H mm					
FAC9911180008	398	449	85	50	88%	100	7035	61,80
FAC9911180004	398	449	85	50	88%	100	5012	61,80
FAC9911180039	398	449	85	50	88%	100	7016	72,30



MATERIALE DI SEPARAZIONE

L ➤ 512 mm



ART.	adatto per cassetto H mm	componenti	€
FFH00500100	100	2 x Divisorio trasversale L=202 mm 1 x Divisorio longitudinale fessurato L=457 mm	7,50



ART.	adatto per cassetto H mm	componenti	€
FFH00500800	100/125	3 x Cassetta divisorio 150x75 mm 6 x Cassetta divisorio 150x150 mm	20,70



ART.	adatto per cassetto H mm	componenti	€
FFH00500900	100/125	15 x Cassetta divisorio 150x75 mm	25,20

L ➤ 1023 mm

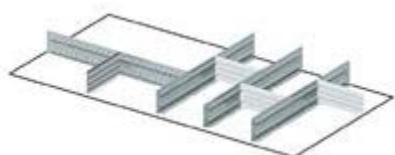

ART.	adatto per cassetto H mm	componenti	€
FFH02000100	100	4 x Divisorio longitudinale fessurato L=457 mm 4 x Divisorio trasversale L=151 mm	23,10



ART.	adatto per cassetto H mm	componenti	€
FFH02000200	100	5 x Divisorio longitudinale fessurato L=457 mm 10 x Divisorio trasversale L=151 mm	35,40



ART.	adatto per cassetto H mm	componenti	€
FFH02000600	100/125	12 x Cassetta divisorio 150x75 mm 12 x Cassetta divisorio 150x150 mm	49,50



PORTATA



ESTRAZIONE



RAL 5012



RAL 7016



RAL 7035



ZINCATO

PERFOM

ARMADI SPOGLIATOIO SERIE PRO



Realizzati in robusta lamiera d'acciaio, gli armadi spogliatoio facilitano la custodia di indumenti e abiti di lavoro. Ogni scomparto ha una **profondità di 500 mm** ed è chiuso da una porta con feritoie per la circolazione dell'aria e **serratura a cilindro con chiave**. La configurazione con **divisorio sporco/pulito** e **tetto inclinato** li rende adatti ad essere impiegati negli ambienti che richiedono un elevato grado di pulizia e che devono rispondere alla normativa HACCP. Gli armadi spogliatoio possono essere ulteriormente arricchiti con **piedini in polipropilene** resistenti all'acqua e **panche** singole di varie dimensioni.

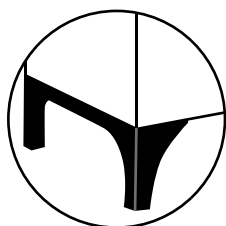

**PIEDINI IN
POLIPROPILENE
FACILE PULIZIA**

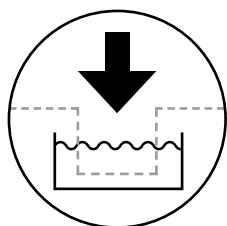

**VERNICIATURA IN
ELETTROFORESI**

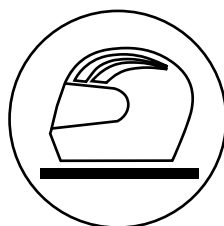

**VERSIONE CON VANO
PORTA CASCO**

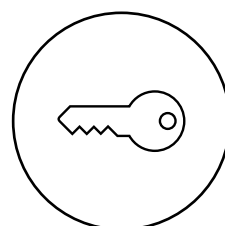

CHIUSURA A CHIAVE



ART.	L mm	P mm	H mm	n. scomparti	RAL	€
 PERFOMAN01	1195	502	1950	4	7035	478,20

Composto da:

qtà	descrizione
1	Armadio spogliatoio a tetto orizzontale a 4 scomparti
1	Coppia piedini per armadio spogliatoio



ART.	L mm	P mm	H mm	n. scomparti	RAL	€
 PERFOMAN02	1195	502	1950	3	7035	478,20

Composto da:

qtà	descrizione
1	Armadio spogliatoio a tetto orizzontale a 3 scomparti
1	Coppia piedini per armadio spogliatoio



ART.	L mm	P mm	H mm	n. scomparti	RAL	€
 PERFOMAN03	1195	502	2170	4	7035	549,90

Composto da:

qtà	descrizione
1	Armadio spogliatoio a tetto orizzontale a 4 scomparti
1	Tetto inclinato aggiuntivo
1	Coppia piedini per armadio spogliatoio





ART.	Lmm	Pmm	Hmm	n. scomparti	RAL	€
 PERFOMAN04	1195	502	2170	3	7035	549,90

Composto da:



qtà	descrizione
1	Armadio spogliatoio a tetto orizzontale a 3 scomparti
1	Tetto inclinato aggiuntivo
1	Coppia piedini per armadio spogliatoio

PANCHINA SINGOLA





ART.	Lmm	Pmm	Hmm		RAL	€
 FAN95400001	1000	360	385/400	200	7000	103,80



ART.	Lmm	Pmm	Hmm		RAL	€
 FAN95500001	1494	360	385/400	200	7000	125,40



ART.	Lmm	Pmm	Hmm		RAL	€
 FAN95600001	2000	360	385/400	300	7000	177,30



ART.	L mm	P mm	H mm	n. scomparti	RAL	€
 FAN1302C00108	608	502	1750	2	7035	280,20

[CONFIGURE](#) 

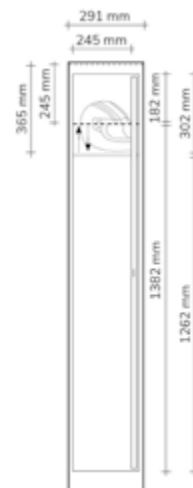

TETTO INCLINATO AGGIUNTIVO



ART.	L mm	P mm	H mm	RAL	€
 FAN51400008	607	502	220	7035	49,50



ART.	L mm	P mm	H mm	n. scomparti	RAL	€
 FAN1303C00108	900	502	1750	3	7035	359,70

[CONFIGURE](#) 

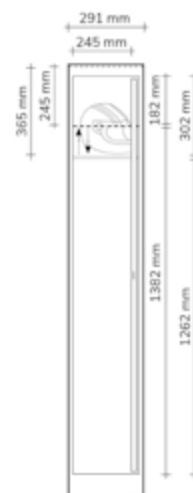

TETTO INCLINATO AGGIUNTIVO



ART.	L mm	P mm	H mm	RAL	€
 FAN51600008	899	502	220	7035	62,10



PORTATA



RAL 7000



RAL 7035



ART.	L mm	P mm	H mm	n. scomparti	RAL	€
FAN1304C00108	1192	502	1750	4	7035	464,70

[CONFIGURE](#)



TETTO INCLINATO AGGIUNTIVO

ART.	L mm	P mm	H mm	RAL	€
FAN51800008	1191	502	220	7035	71,70



COPPIA PIEDINI PER ARMADIO SPOGLIATOIO



ART.	L mm	P mm	H mm	colore	€
FRR23100001	135	500	180/200	Grigio scuro	13,50



ART.	L mm	P mm	H mm	n. scomparti	RAL	€
 FAN1502C03108	802	502	1750	2	7035	340,80

[CONFIGURE](#) 

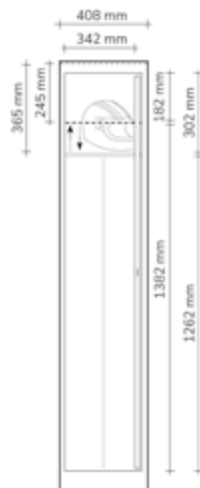

TETTO INCLINATO AGGIUNTIVO



ART.	L mm	P mm	H mm	RAL	€
 FAN51500008	801	502	220	7035	54,30



ART.	L mm	P mm	H mm	n. scomparti	RAL	€
 FAN1503C03108	1192	502	1750	3	7035	464,70

[CONFIGURE](#) 

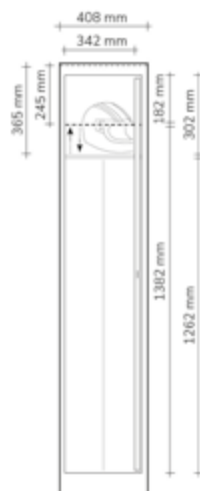

TETTO INCLINATO AGGIUNTIVO



ART.	L mm	P mm	H mm	RAL	€
 FAN51800008	1191	502	220	7035	71,70

NC

PORTA UTENSILI SERIE PRO



Le soluzioni NC presentano apposite boccole e telai per l'organizzazione sicura e ordinata di mandrini e altri utensili tipicamente impiegati nei macchinari a controllo numerico. Le **boccole in ABS** sono resistenti ad urti, possono essere facilmente pulite e sono disponibili in diverse dimensioni in base alla tipologia di strumento da contenere. Sono posizionate su **telai orizzontali o inclinati** che possono essere installati direttamente su un supporto da banco, su un carrello o inseriti in armadi all'interno di cassette o in sostituzione dei ripiani.

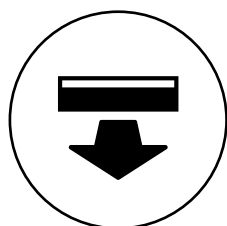

**CASSETTI AD
ESTRAZIONE TOTALE**



**ARMADIO PORTATA
1200 KG**

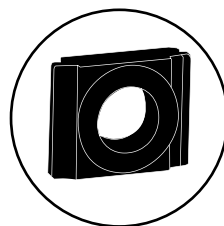

**VASTA GAMMA DI
BOCCOLE**

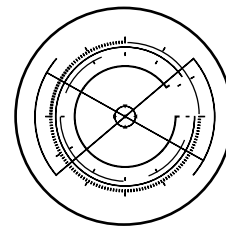

CONFIGURABILE

PORTA UTENSILI



[CONFIGURE](#)









[CONFIGURE](#)

ART.	L mm	P mm	H mm	KG	n. coppia telai per armadio	n. coppia telai per cassetto	n. cassetti	n. boccole	tipo boccole	RAL	€
 PERFORMNC01	1023	555	2000	1200	2	-	-	84	ISO 40	7035	952,20
 PERFORMNC02	1023	555	2000	1200	2	-	-	84	ISO 40	5012	952,20
 PERFORMNC03	1023	555	2000	1200	2	-	-	50	ISO 50	7035	865,20
 PERFORMNC04	1023	555	2000	1200	2	-	-	50	ISO 50	5012	865,20
 PERFORMNC05	1023	555	2000	1200	2	-	-	60	HSKA63-B80	7035	898,20
 PERFORMNC06	1023	555	2000	1200	2	-	-	60	HSKA63-B80	5012	898,20
 PERFORMNC07	1023	555	2000	1200	1	1	2	84	ISO 40	7035	1131,30
 PERFORMNC08	1023	555	2000	1200	1	1	2	84	ISO 40	5012	1131,30
 PERFORMNC09	1023	555	2000	1200	1	1	2	50	ISO 50	7035	1044,30
 PERFORMNC10	1023	555	2000	1200	1	1	2	50	ISO 50	5012	1044,30
 PERFORMNC11	1023	555	2000	1200	1	1	2	60	HSKA63-B80	7035	1077,30
 PERFORMNC12	1023	555	2000	1200	1	1	2	60	HSKA63-B80	5012	1077,30



[CONFIGURE](#)

ART.	L mm	P mm	H mm	KG senza ruote	KG set ruote	n. telai	n. boccole	tipo boccole	RAL	€
 COMBINC01	1064	512	892	500	825	3	35	ISO 40	7035+7000	539,70
 COMBINC02	1064	512	892	500	825	3	35	ISO 40	5012+7000	539,70
 COMBINC03	1064	512	892	500	825	3	25	ISO 50	7035+7000	517,20
 COMBINC04	1064	512	892	500	825	3	25	ISO 50	5012+7000	517,20
 COMBINC05	1064	512	892	500	825	3	25	HSKA63-B80	7035+7000	517,20
 COMBINC06	1064	512	892	500	825	3	25	HSKA63-B80	5012+7000	517,20



PORTATA



RAL 7035+RAL 7000



RAL 5012+RAL 7000



RAL 5012

































RAL 7035



TELAIO PORTA BOCCOLE DA BANCO

ART.	L mm	P mm	H mm	RAL	€
 FNC20100008	565	450	351	7035	92,40
 FNC20100004	565	450	351	5012	92,40

BOCCOLA

ART.	tipo	Multiplo d'ordine	q.tà max					€
								
 FNC95100003	ISO 30	7	7	21	42	35	21	3,00
 FNC95300003	ISO 40	7	7	21	42	35	21	3,00
 FNC95400003	ISO 45	6	6	18	30	30	18	3,30
 FNC95500003	ISO 50	5	5	15	25	20	15	3,30
 FNC95600003	VDI30	7	7	21	42	35	21	3,30
 FNC95700003	VDI40	5	5	15	30	30	15	3,30
 FNC95800003	VDI50	5	5	15	30	30	15	4,20
 FNC95900003	VDI60	5	5	15	25	20	15	7,50
 FNC97200003	CONO MORSE 2	7	7	21	42	35	21	3,30
 FNC97300003	CONO MORSE 3	7	7	21	42	35	21	3,30
 FNC97400003	CONO MORSE 4	7	7	21	42	35	21	3,30
 FNC97500003	CONO MORSE 5	5	5	15	30	30	15	3,30
 FNC92700003	CAPTO C3	7	7	21	42	35	21	4,20
 FNC92750003	CAPTO C4	5	5	15	30	30	15	4,20
 FNC92800003	CAPTO C5	5	5	15	30	30	15	4,20
 FNC92850003	CAPTO C6	5	5	15	30	30	15	4,20
 FNC92900003	CAPTO C8	5	5	15	20	20	15	4,20
 FNC92100003	HSKA32-B40	7	7	21	42	35	21	3,30
 FNC92200003	HSKA40-B50	7	7	21	42	35	21	3,30
 FNC92300003	HSKA50-B63	5	5	15	30	30	15	3,30
 FNC92400003	HSKA63-B80	5	5	15	30	30	15	3,30
 FNC92500003	HSKA80-B100	5	5	15	20	20	15	4,20
 FNC92600003	HSK A100-B125	5	5	15	20	20	15	4,20
 FNC96400003	2"	6	6	18	30	30	18	4,20
 FNC96500003	2" 1/4	5	5	15	25	20	15	7,50

COMPONENTI



ARMADIO A PORTE A BATTENTE 54X27 EH

ART.	L mm	P mm	H mm	KG	RAL	€
FAA1420C000PD	1023	555	2000	1200	7035+7016	426,60
FAA1420C00008	1023	555	2000	1200	7035	426,60
FAA1420C00004	1023	555	2000	1200	5012	426,60

CASSETTI AD ESTRAZIONE TELESCOPICA 54X27 EH

ART.	dim. utili			KG		h frontale cassetto	RAL	€
	L mm	P mm	H mm					
FAC9912190008	908	449	85	100	100%	100	7035	99,00
FAC9912190004	908	449	85	100	100%	100	5012	99,00
FAC9912190039	908	449	85	100	100%	100	7016	116,10
FAC9912210008	908	449	135	100	100%	150	7035	112,20
FAC9912210004	908	449	135	100	100%	150	5012	112,20
FAC9912210039	908	449	135	100	100%	150	7016	124,50



TELAIO PORTA BOCCOLE A 3 FILE PER CASSETTO COMPLETO DI SUPPORTI - CONFEZIONE 2 PEZZI

boccole escluse

ART.	L mm	P mm	H mm	RAL	€
FNC5140S101	894	446	142/180	7000	117,90



TELAIO PORTA BOCCOLE A 3 FILE PER ARMADIO - CONFEZIONE 2 PEZZI

ART.	L mm	P mm	H mm	KG	RAL	€
FNC5160S101	965	444	68	150	7000	136,80



RUOTA GIREVOLE



RUOTA GIREVOLE CON FRENO



RUOTA FISSA

CARRELLO PORTA UTENSILI CON RUOTE

ART.	L mm	P mm	H mm	KG senza ruote	ruote					RAL	€
					Ø mm	materiale	KG set ruote				
FCNF1001056	1064	512	892	500	125	Nylon	825	2	2	7035+7000	434,70
FCNF1001051	1064	512	892	500	125	Nylon	825	2	2	5012+7000	434,70



PORTATA



ESTRAZIONE



RAL 7035 + RAL 7016



RAL 7035 + RAL 7000



RAL 5012 + RAL 7000



RAL 5012



RAL 7000



RAL 7016



RAL 7035

ECOLOGIA

PRODOTTI PER ECOLOGIA SERIE PRO



Le vasche di raccolta prevengono gli sversamenti accidentali di sostanze pericolose ed inquinanti, in ottemperanza al D.Lgs. N.152/2006 e D.Lgs. N.81/2008. Attenzione! Si ricorda di non stoccare nella stessa vasca sostanze chimiche che a contatto tra loro possano reagire e di verificare la compatibilità delle sostanze pericolose stoccate con il materiale di fabbricazione di vasca e griglia. La capacità dei contenitori stoccabili sopra ogni vasca e le informazioni fornite, non esaustive né vincolanti, sono valide per il territorio italiano. Per altri Paesi, attenersi alle disposizioni specifiche vigenti nel Paese di utilizzo e contattare le autorità locali competenti per maggiori informazioni.



VASCHE DI RACCOLTA + RIPIANI E VASCHE PERFORM IN ACCIAIO

Idonee a liquidi infiammabili delle categorie **GHS 1 – 3** e liquidi inquinanti per le acque delle categorie **GHS 1 – 4**.

Non sono ammesse **sostanze corrosive**.

VASCHE DI RACCOLTA IN PE

Idonee a liquidi inquinanti per le acque delle categorie **GHS 1 – 4**.

Non sono ammesse **sostanze infiammabili**.



BENNE

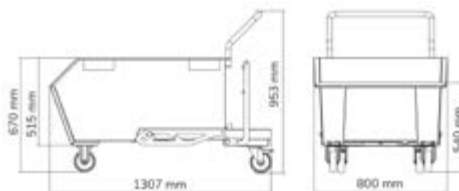

BENNA PORTAROTTAMI RIBALTABILE CAPACITÀ 300 L CON RUOTE PREDISPOSTA PER GRIGLIA E RUBINETTO

ART.	L mm	P mm	H mm	L	KG	ruote						RAL	€
						Ø mm	h mm	materiale	KG set ruote	☞	☛		
FAXEPR030060039	1307	800	953	300	600	125	155	Nylon	825	2	2	7016	774,00

Benna fornita smontata

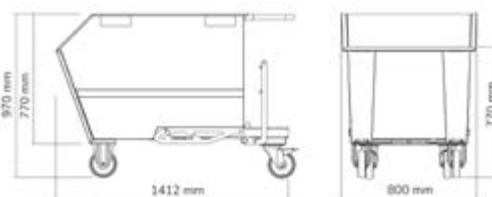

BENNA PORTAROTTAMI RIBALTABILE CAPACITÀ 500 L CON RUOTE PREDISPOSTA PER GRIGLIA E RUBINETTO

ART.	L mm	P mm	H mm	L	KG	ruote						RAL	€
						Ø mm	h mm	materiale	KG set ruote	☞	☛		
FAXEPR050060039	1412	800	970	500	1000	160	200	Nylon	1050	2	2	7016	885,00

Benna fornita smontata



PORTATA



CAPACITÀ



RUOTA FISSA



RUOTA GIREVOLE CON FRENO

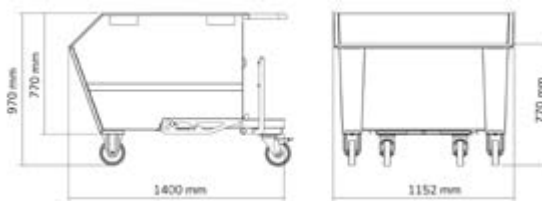

RAL 7016

BENNE

CE

PATENTED

BENNA PORTAROTTAMI RIBALTABILE CAPACITÀ 750 L CON RUOTE PREDISPOSTA PER GRIGLIA E RUBINETTO

ART.	L mm	P mm	H mm	L	KG	ruote						RAL	€
						Ø mm	h mm	materiale	KG set ruote	↻	⌵		
FAXEPR075060039	1400	1152	970	750	1350	160	200	Nylon	1050	2	2	7016	1033,20

Benna fornita smontata

CILINDRO IDRAULICO PER IL RIBALTAMENTO FRENATO DELLA BENNA

CILINDRO IDRAULICO PER BENNA

ART.	L mm	P mm	H mm	€
FAXEAC004000007	401/671	42	42	95,70

RUBINETTO FRONTALE PER LO SCARICO DEI LIQUIDI RESIDUI

KIT RUBINETTO + GRIGLIA

ART.	L mm	P mm	H mm	adatto per	€
FAXEAC001000099	700	388	25	FAXEPR0300600	90,00
FAXEAC003000099	685	388	25	FAXEPR0500600	90,00
FAXEAC002000099	1028	388	25	FAXEPR0750600	108,90

PORTA BIG BAG



Telaio fornito smontato su paletta

CE

PATENTED

PORTA BIG BAG REGOLABILE IN ALTEZZA

ART.	L mm	P mm	H mm	KG	RAL	€
 FAXEBB1002H0039	1090	1084	1205/1395	1000	7016	370,80



Big bag escluso

- Gambe regolabili in altezza (1205 - 1395 mm) per ospitare big bag di due misure diverse
- Ripiani inferiori lisci per maggiore sostegno al sacco
- Portata testata: 1000 kg
- Sovrapposizione: 1+2 telai
- Possibilità di inserire e sfilare il big bag anche in caso di telai sovrapposti
- Imballo in cartone su pallet non fumigato



PORTATA



CAPACITÀ



RUOTA FISSA



RUOTA GIREVOLE CON FRENO



RAL 7016



VASCA CONICA DI RACCOLTA CAPACITÀ 200 L

ART.	L mm	P mm	H mm	RAL	€
 ECO1314	1310	800	351	7016	356,70

Composto da:

qtà	descrizione
1	Vasca conica di raccolta capacità 200 L
2	Kit 2 doghe
1	Kit 2 pettini per vasca conica



vedi pag. 364



VASCA DI RACCOLTA CAPACITÀ 200 L

ART.	L mm	P mm	H mm	RAL	€
 ECO1315	1300	805	400	7016	366,30

Composto da:

qtà	descrizione
1	Vasca di raccolta capacità 200 L
2	Kit 2 doghe
1	Kit 2 pettini L=800 mm



vedi pag. 364



VASCA DI RACCOLTA CAPACITÀ 300 L

ART.	L mm	P mm	H mm	RAL	€
 ECO1316	1300	1205	400	7016	455,40

Composto da:

qtà	descrizione
1	Vasca di raccolta capacità 300 L
3	Kit 2 doghe
1	Kit 2 pettini L=1200 mm



vedi pag. 364

VASCHE DI RACCOLTA

VASCA DI RACCOLTA CAPACITÀ 400 L

ART.	L mm	P mm	H mm	RAL	€
 ECO1318	1300	1222	400	7016	483,90



Composto da:

qtà	descrizione
1	Vasca di raccolta capacità 300 L
3	Kit 2 doghe
1	Kit 2 pettini L=1200 mm
1	Kit 2 tappi con guarnizioni

Grazie all'utilizzo del kit tappi la capacità della vasca da 300 litri aumenta a 400 litri



vedi pag. 364



VASCA DI RACCOLTA CAPACITÀ 800 L

ART.	L mm	P mm	H mm	RAL	€
 ECO1319	1300	2422	400	7016	967,80

Composto da:

qtà	descrizione
2	Vasca di raccolta capacità 300 L
6	Kit 2 doghe
2	Kit 2 pettini L=1200 mm
1	Kit di accoppiamento vasche
1	Kit 2 tappi con guarnizioni



vedi pag. 364

Fusti esclusi



Esempio accoppiamento vasche:

1. Kit di accoppiamento vasche (composto da profilo in acciaio zincato salvagoccia e collettore con due guarnizioni)
2. Kit 2 tappi con guarnizioni

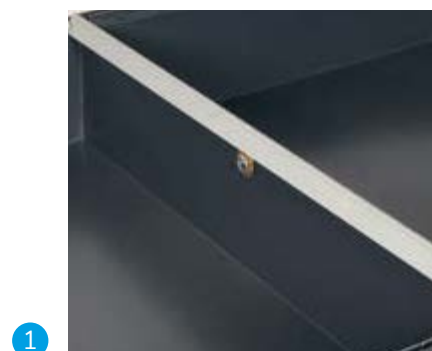

PORTATA



RAL 7016

VASCHE DI RACCOLTA

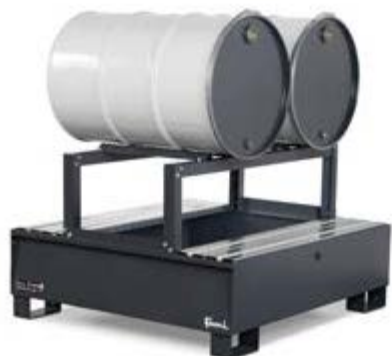

VASCA DI RACCOLTA CAPACITÀ 300 L CON PORTA FUSTI

ART.	L mm	P mm	H mm	RAL	€
 ECO1322	1300	1205	787	7016	543,60

Composto da:

qtà	descrizione
1	Vasca di raccolta capacità 300 L
2	Kit 2 doghe
1	Porta fusti per 2 fusti



vedi pag. 364

Fusti esclusi



VASCA DI RACCOLTA CAPACITÀ 200 L CON RUOTE

ART.	L mm	P mm	H mm	RAL	€
 ECO1320	1491	800	1018	7016	477,60

Composto da:

qtà	descrizione
1	Vasca di raccolta capacità 200 L
2	Kit 2 doghe
1	Kit 2 pettini L=800 mm
1	Maniglia per vasca
1	Kit ruote in nylon Ø 125 mm



vedi pag. 364

Fusti esclusi



VASCHE DI RACCOLTA



VASCA DI RACCOLTA CAPACITÀ 1000 L

ART.	L mm	P mm	H mm	RAL	€
 ECO1317	1600	1300	640	7016	911,40

Composto da:

qtà	descrizione
1	Vasca di raccolta capacità 1000 L
4	Kit 2 doghe
2	Kit 2 pettini L=800 mm



vedi pag. 364

Cisterna esclusa



VASCA DI RACCOLTA CAPACITÀ 1000 L CON TELAIO

ART.	L mm	P mm	H mm	RAL	€
 ECO1321	1600	1306	1065	7016	1072,80

Composto da:

qtà	descrizione
1	Vasca di raccolta capacità 1000 L
4	Kit 2 doghe
1	Telaio per vasca di raccolta



vedi pag. 364

Cisterna esclusa



VASCHE DI RACCOLTA



vedi pag. 364

Cisterne escluse

VASCA DI RACCOLTA CAPACITÀ 1100 L CON TELAI

ART.	L mm	P mm	H mm	RAL	€
 ECO1323	1306	3222	825	7016	1690,50

Composto da:

qtà	descrizione
2	Vasca di raccolta capacità 300 L
1	Vasca di raccolta capacità 200 L
8	Kit 2 doghe
2	Telaio per vasca di raccolta
1	Kit 2 tappi con guarnizioni
2	Kit di accoppiamento vasche

Grazie all'utilizzo del kit tappi la capacità della vasca da 300 litri aumenta a 400 litri, mentre il volume di contenimento della vasca da 200 litri aumenta a 300 litri.



Esempio accoppiamento vasche:

1. Vasca di raccolta capacità 300 L
2. Vasca di raccolta capacità 200 L
3. Kit 2 tappi con guarnizioni
4. Kit di accoppiamento vasche (composto da profilo in acciaio zincato salvagoccia e collettore con due guarnizioni)

VASCHE DI RACCOLTA



vedi pag. 364

Cisterne escluse

VASCA DI RACCOLTA CAPACITÀ 1200 L

ART.	L mm	P mm	H mm	RAL	€
 ECO1324	1300	3627	400	7016	1451,70

Composto da:

qtà	descrizione
3	Vasca di raccolta capacità 300 L
9	Kit 2 doghe
3	Kit 2 pettini L=1200 mm
2	Kit di accoppiamento vasche
1	Kit 2 tappi con guarnizioni



Esempio accoppiamento vasche:

1. Kit di accoppiamento vasche (composto da profilo in acciaio zincato salvagoccia e collettore con due guarnizioni)
2. Kit 2 tappi con guarnizioni



VASCHE DI RACCOLTA



SUPPORTO IN POLIETILENE PER RIALZO

ART.	L mm	P mm	H mm	per fusti		colore	€
				n.	L		
FAX002068000005	465	610	410	1	200	Giallo	148,50
FAX002070000005	1200	780	255	2	200	Giallo	362,40



VASCA DI RACCOLTA IN POLIETILENE CON GRIGLIA PER FUSTI

ART.	L mm	P mm	H mm	L	per fusti		colore	€
					n.	L		
FAX002064000005	925	800	420	225	1	200	Giallo	353,10
FAX002065000005	1350	800	420	305	2	200	Giallo	631,50
FAX002066000005	1350	1350	490	500	4	200	Giallo	862,50



vedi pag. 364



VASCA DI RACCOLTA IN POLIETILENE CON GRIGLIA PER CISTERNA

ART.	L mm	P mm	H mm	L	per cisterna		colore	€
					n.	L		
FAX002067000005	1350	1350	970	1050	1	1000	Giallo	1242,00



vedi pag. 364



ARMADI DI SICUREZZA



CONFIGURE



CONFIGURE



CONFIGURE

ART.	L mm	P mm	H mm	KG	RAL	€
PERFORM12013	1048	600	1027	800	1004	472,50
PERFORM12014	1048	600	1027	800	7035+7016	472,50
PERFORM12015	1048	600	1027	800	7035	472,50
PERFORM12016	1048	600	1027	800	5012	472,50

Composto da:

qtà	descrizione
1	Armadio con porte a battente fessurate
1	Piano fessurato
1	Vasca stagna esterna di raccolta liquidi capacità 59 L



vedi pag. 364



ART.	L mm	P mm	H mm	KG	RAL	€
PERFORM12017	1023	555	1000	800	1004	451,20
PERFORM12018	1023	555	1000	800	7035+7016	451,20
PERFORM12019	1023	555	1000	800	7035	451,20
PERFORM12020	1023	555	1000	800	5012	451,20

Composto da:

qtà	descrizione
1	Armadio con porte a battente fessurate
1	Kit 2 vasche stagne interne di raccolta liquidi capacità 19 L



vedi pag. 364

ART.	L mm	P mm	H mm	KG	RAL	€
PERFORM12025	1048	600	1027	800	6011	472,50

Composto da:

qtà	descrizione
1	Armadio con porte a battente fessurate
1	Piano fessurato
1	Vasca stagna esterna di raccolta liquidi capacità 59 L



vedi pag. 364



PORTATA



CAPACITÀ



RAL 7035 + RAL 7016



RAL 1004



RAL 5012



RAL 6011



RAL 7016



RAL 7035

ARMADI DI SICUREZZA



CONFIGURE

ART.	L mm	P mm	H mm	KG	RAL	€
PERFOM14056	1048	600	2027	1200	6011	599,40

Composto da:

qtà	descrizione
1	Armadio con porte a battente fessurate
1	Kit 3 piani fessurati
1	Vasca stagna esterna di raccolta liquidi capacità 59 L



vedi pag. 364



CONFIGURE

ART.	L mm	P mm	H mm	KG	RAL	€
PERFOM14057	1023	555	2000	1200	6011	636,60

Composto da:

qtà	descrizione
1	Armadio con porte a battente fessurate
2	Kit 2 vasche stagne interne di raccolta liquidi capacità 19 L



vedi pag. 364



CONFIGURE

ART.	L mm	P mm	H mm	KG	RAL	€
PERFOM14058	1023	555	2000	1200	7035	766,20

Composto da:

qtà	descrizione
1	Armadio con porte a battente fessurate in policarbonato
2	Kit 2 vasche stagne interne di raccolta liquidi capacità 19 L



vedi pag. 364



CONFIGURE

ART.	L mm	P mm	H mm	KG	RAL	€
PERFOM14025	1048	600	2027	1200	1004	599,40
PERFOM14026	1048	600	2027	1200	7035+7016	599,40
PERFOM14027	1048	600	2027	1200	7035	599,40
PERFOM14028	1048	600	2027	1200	5012	599,40

Composto da:

qtà	descrizione
1	Armadio con porte a battente fessurate
1	Kit 3 piani fessurati
1	Vasca stagna esterna di raccolta liquidi capacità 59 L



vedi pag. 364



CONFIGURE

ART.	L mm	P mm	H mm	KG	RAL	€
PERFOM14029	1023	555	2000	1200	1004	636,60
PERFOM14030	1023	555	2000	1200	7035+7016	636,60
PERFOM14031	1023	555	2000	1200	7035	636,60
PERFOM14032	1023	555	2000	1200	5012	636,60

Composto da:

qtà	descrizione
1	Armadio con porte a battente fessurate
2	Kit 2 vasche stagne interne di raccolta liquidi capacità 19 L



vedi pag. 364



CLEVER-COMBI

CARRELLI SERIE PRO



Clever e Combi sono pratici carrelli per la movimentazione di prodotti e attrezzatura nell'ambiente di lavoro. In particolare, **Clever** è un innovativo **carrello componibile** che può essere impiegato anche come carrello officina grazie alla possibilità di personalizzarlo con ripiani o piano di lavoro in legno, cassetti, pannelli forati, porte, ganci e accessori Iron Team. **Combi**, invece, presenta uno o due **pianali** che lo rendono ideale all'utilizzo in **magazzino** per la movimentazione di semilavorati o prodotti.

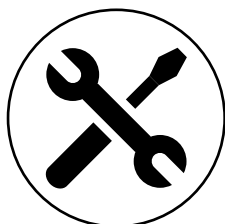

FACILI DA
MONTARE



PORTATA PIANI 100
KG

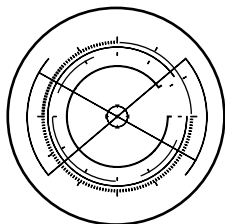

CONFIGURABILE

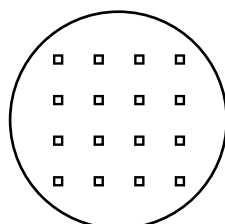



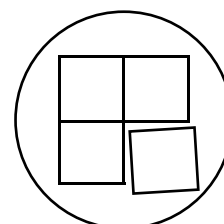

FORI QUADRI
10X10



COMPONIBILI







ART.	L mm	P mm	H mm	 senza ruote	 set ruote	RAL	€
 CLEVER0903	908	515	819	300	225	7035	152,70
 CLEVER0904	908	515	819	300	225	5012	152,70

Composto da:

qtà	descrizione
1	Carrello smontato senza ruote
1	Kit ruote in gomma standard Ø 100 mm

[CONFIGURE](#) 



ART.	L mm	P mm	H mm	 senza ruote	 set ruote	RAL	€
 CLEVER0905	908	515	819	300	225	7035	194,10
 CLEVER0906	908	515	819	300	225	5012	194,10

Composto da:

qtà	descrizione
1	Carrello smontato senza ruote
1	Piano aggiuntivo
1	Kit ruote in gomma standard Ø 100 mm

[CONFIGURE](#) 



ART.	L mm	P mm	H mm	 senza ruote	 set ruote	RAL	€
 CLEVER0907	908	515	846	300	300	7035	203,40
 CLEVER0908	908	515	846	300	300	5012	203,40

Composto da:

qtà	descrizione
1	Carrello smontato senza ruote
1	Piano aggiuntivo
1	Kit ruote in gomma antitraccia sintetica Ø 125 mm

[CONFIGURE](#) 



ART.	L mm	P mm	H mm	senza ruote	set ruote	RAL	€
CLEVER1003	1028	615	819	300	225	7035	171,30
CLEVER1004	1028	615	819	300	225	5012	171,30

Composto da:

qtà	descrizione
1	Carrello smontato senza ruote
1	Kit ruote in gomma standard Ø 100 mm

[CONFIGURE](#)



ART.	L mm	P mm	H mm	senza ruote	set ruote	RAL	€
CLEVER1005	1028	615	846	300	300	7035	225,60
CLEVER1006	1028	615	846	300	300	5012	225,60

Composto da:

qtà	descrizione
1	Carrello smontato senza ruote
1	Piano aggiuntivo
1	Kit ruote in gomma standard Ø 125 mm

[CONFIGURE](#)



ART.	L mm	P mm	H mm	senza ruote	set ruote	RAL	€
CLEVER1007	1028	615	846	300	300	7035	230,10
CLEVER1008	1028	615	846	300	300	5012	230,10

Composto da:

qtà	descrizione
1	Carrello smontato senza ruote
1	Piano aggiuntivo
1	Kit ruote in gomma antitraccia sintetica Ø 125 mm

[CONFIGURE](#)



ART.	L mm	P mm	H mm	senza ruote	set ruote	RAL	€
CLEVER1009	1028	615	868	300	300	7035	286,80
CLEVER1010	1028	615	868	300	300	5012	286,80

Composto da:

qtà	descrizione
1	Carrello smontato senza ruote
1	Piano in legno con supporti
1	Kit ruote in gomma antitraccia sintetica Ø 125 mm

[CONFIGURE](#)



ART.	L mm	P mm	H mm	senza ruote	set ruote	RAL	€
CLEVER1011	1030	615	846	300	300	7035	302,10
CLEVER1012	1030	615	846	300	300	5012	302,10

Composto da:

qtà	descrizione
1	Carrello smontato senza ruote
1	Piano aggiuntivo
2	Pannello laterale forato
1	Kit ruote in gomma antitraccia sintetica Ø 125 mm

[CONFIGURE](#)



ART.	L mm	P mm	H mm	senza ruote	set ruote	RAL	€
CLEVER1013	1030	615	868	300	300	7035	358,80
CLEVER1014	1030	615	868	300	300	5012	358,80

Composto da:

qtà	descrizione
1	Carrello smontato senza ruote
1	Piano in legno con supporti
2	Pannello laterale forato
1	Kit ruote in gomma antitraccia sintetica Ø 125 mm

[CONFIGURE](#)



PORTATA



RAL 5012



RAL 7035



ART.	L mm	P mm	H mm	senza ruote	set ruote	RAL	€
CLEVER1015	1030	630	868	300	300	7035	411,30
CLEVER1016	1030	630	868	300	300	5012	411,30

Composto da:

qtà	descrizione
1	Carrello smontato senza ruote
1	Piano in legno con supporti
2	Pannello laterale forato
1	Pannello posteriore forato
1	Kit ruote in gomma antitraccia sintetica Ø 125 mm

[CONFIGURE](#)



ART.	L mm	P mm	H mm	senza ruote	set ruote	RAL	€
CLEVER1017	1030	655	868	300	300	7035	564,30
CLEVER1018	1030	655	868	300	300	5012	564,30

Composto da:

qtà	descrizione
1	Carrello smontato senza ruote
1	Piano in legno con supporti
2	Pannello laterale forato
1	Pannello posteriore forato
1	Coppia porte a battente
1	Kit ruote in gomma antitraccia sintetica Ø 125 mm

[CONFIGURE](#)



ART.	L mm	P mm	H mm	senza ruote	set ruote	RAL	€
CLEVER1019	1028	615	846	300	300	7035+7016	333,60
CLEVER1020	1028	615	846	300	300	5012	329,10

Composto da:

qtà	descrizione
1	Carrello smontato senza ruote
1	Piano aggiuntivo
1	Armadio L=500 mm con 1 cassetto H=150 mm
1	Kit ruote in gomma antitraccia sintetica Ø 125 mm

[CONFIGURE](#)



ART.	L mm	P mm	H mm	senza ruote	set ruote	RAL	€
CLEVER1021	1030	633	1538	300	300	7035	445,20
CLEVER1022	1030	633	1538	300	300	5012	445,20

Composto da:

qtà	descrizione
1	Carrello smontato senza ruote
1	Piano in legno con supporti
2	Pannello laterale forato
1	Pannello posteriore forato
1	Coppia montanti per fissaggio pannello
1	Kit ruote in gomma antitraccia sintetica Ø 125 mm

[CONFIGURE](#)



ART.	L mm	P mm	H mm	senza ruote	set ruote	RAL	€
CLEVER1023	1030	658	1538	300	300	7035	650,70
CLEVER1024	1030	658	1538	300	300	5012	650,70

Composto da:

qtà	descrizione
1	Carrello smontato senza ruote
1	Piano in legno con supporti
2	Pannello laterale forato
2	Pannello posteriore forato
1	Coppia montanti per fissaggio pannello
1	Coppia porte a battente
1	Kit ruote in gomma antitraccia sintetica Ø 125 mm

[CONFIGURE](#)



ART.	L mm	P mm	H mm	senza ruote	set ruote	RAL	€
CLEVER1025	1028	654	1538	300	300	7035+7016	476,70
CLEVER1026	1028	654	1538	300	300	5012	472,20

Composto da:

qtà	descrizione
1	Carrello smontato senza ruote
1	Piano in legno con supporti
1	Pannello posteriore forato
1	Coppia montanti per fissaggio pannello
1	Armadio L=500 mm con 1 cassetto H=150 mm
1	Kit ruote in gomma antitraccia sintetica Ø 125 mm

[CONFIGURE](#)



PORTATA



RAL 7035 + RAL 7016



RAL 5012



RAL 7035



CONFIGURE

ART.	L mm	P mm	H mm	senza ruote	set ruote	RAL	€
CLEVER1027	1347	633	1538	300	300	7035	689,10
CLEVER1028	1347	633	1538	300	300	5012	689,10

Composto da:

qtà	descrizione
1	Carrello smontato senza ruote
1	Piano in legno con supporti
2	Pannello laterale forato
1	Pannello posteriore forato
1	Coppia montanti per fissaggio pannello
1	Mensola grande reversibile
1	Barra aggancio per contenitori Picking Box mis. 1/2
1	Kit 3 contenitori Picking Box Air mis. 2
1	Porta bombolette a 6 posti
2	Porta silicone inclinato a 2 posti
1	Kit porta rotolo con carta Ø=240 mm
2	Calamita completa di clip e vite - confezione 10 pezzi
1	Kit ruote in gomma antitraccia sintetica Ø 125 mm



CONFIGURE



ART.	L mm	P mm	H mm	KG senza ruote	KG set ruote	RAL	€
CLEVER1029	1347	658	1538	300	300	7035	1066,50
CLEVER1030	1347	658	1538	300	300	5012	1066,50

Composto da:

qtà	descrizione
1	Carrello smontato senza ruote
1	Piano in legno con supporti
2	Pannello laterale forato
2	Pannello posteriore forato
1	Coppia montanti per fissaggio pannello
1	Coppia porte a battente
1	Kit porta rotolo con carta Ø=240 mm
1	Porta bombolette a 6 posti
2	Mensola grande reversibile
1	Cestino capacità 30 L
1	Cavo di collegamento wieland schuko/francese
1	Multipresa schuko a 4 scomparti
1	Multipresa schuko a 2 scomparti
1	Supporto multipresa a 4 scomparti
1	Supporto multipresa a 2 scomparti
2	Calamita completa di clip e vite - confezione 10 pezzi
1	Kit ruote in gomma antitraccia sintetica Ø 125 mm



PORTATA



RAL 5012



RAL 7035



CARRELLO SMONTATO SENZA RUOTE

ART.	L mm	P mm	H mm	KG	RAL	€
FCR10S0X208	908	515	691	300	7035	108,60
FCR10S0X204	908	515	691	300	5012	108,60
FCR11S0X208	1028	615	691	300	7035	127,20
FCR11S0X204	1028	615	691	300	5012	127,20



KIT RUOTE

ART.	Ø mm	KG set ruote	H mm	materiale			€
FKRD1002107	100	225	128	Gomma standard	2	2	44,10
FKRB1252107	125	300	155	Gomma standard	2	2	48,90
FKRU1252101	125	300	155	Gomma antitraccia sintetica	2	2	53,40
FKRS1252101	125	750	155	Gomma elastica	2	2	85,20



PIANO AGGIUNTIVO

ART.	L mm	P mm	H mm	adatto per	KG	RAL	€
FCR10120108	810	510	35	Carrello Clever Small	100	7035	41,40
FCR10120104	810	510	35		100	5012	41,40
FCR11120108	930	610	35	Carrello Clever Large	100	7035	49,50
FCR11120104	930	610	35		100	5012	49,50





PANNELLO POSTERIORE FORATO

ART.	L mm	P mm	H mm	adatto per	Dim. foro mm	Passo mm	RAL	€
 FCR11150108	895	22	690	Carrello Clever Large	10x10	38	7035	52,50
 FCR11150104	895	22	690		10x10	38	5012	52,50

 Per l'installazione sulla parte superiore del carrello è necessario ordinare la coppia montanti



COPIA MONTANTI PER FISSAGGIO PANNELLO

ART.	L mm	P mm	H mm	RAL	€
 FCR10170139	45	35	650	7016	33,90

 Per l'installazione sulla parte superiore del carrello è necessario ordinare la coppia montanti



COPIA PORTE A BATTENTE

ART.	L mm	P mm	H mm	adatto per	Dim. foro mm	Passo mm	RAL	€
 FCR11160108	936	44	690	Carrello Clever Large	10x10	38	7035	153,00
 FCR11160104	936	44	690		10x10	38	5012	153,00



PANNELLO LATERALE FORATO

ART.	L mm	P mm	H mm	adatto per	Dim. foro mm	Passo mm	RAL	€
 FCR11140108	573	7	688	Carrello Clever Large	10x10	38	7035	36,00
 FCR11140104	573	7	688		10x10	38	5012	36,00





PIANO IN LEGNO CON SUPPORTI

ART.	L mm	P mm	H mm	adatto per	KG	€
 FCR11130100	930	610	51	Carrello Clever Large	100	106,20



ARMADIO L=500 MM CON 1 CASSETTO H=150 MM

ART.	L mm	P mm	H mm	KG	RAL	€
 FBG03S50C0001PD	500	630	210	80	7035+7016	103,50
 FBG03S50C000104	500	630	210	80	5012	99,00

IRONTEAM

vedi pag. 196



FBLIT020099
FBLIT0610LQ



FBL95410000



FBLIT008039



FBLIT004039



FBLIT010039



FBLIT017039



FBLET012007



FBLET004007



FBLET005007



FBLET016007



CARELLO CON BASE IN ACCIAIO CON RUOTE

ART.	L mm	P mm	H mm	senza ruote	ruote			RAL	€	
					Ø mm	materiale	set ruote			
FCEP1052004	1095	700	1000	500	200	Gomma standard	615	1 1 2	5012	333,00



CARELLO CON BASE IN ACCIAIO CON RUOTE

ART.	L mm	P mm	H mm	senza ruote	ruote			RAL	€	
					Ø mm	materiale	set ruote			
FCEB1050308	1135	700	915	500	125	Gomma standard	300	1 1 2	7035	179,10
FCEB1050304	1135	700	915	500	125	Gomma standard	300	1 1 2	5012	179,10



CARELLO CON BASE IN ACCIAIO CON RUOTE

ART.	L mm	P mm	H mm		ruote		RAL	€
					Ø mm			
FCR00210008	555	445	845	150	100	4	7035	135,00
FCR00210004	555	445	845	150	100	4	5012	135,00



PORTATA



RUOTA FISSA



RUOTA GIREVOLE



RUOTA GIREVOLE CON FRENO



RAL 7035 + RAL 7016



RAL 5012



RAL 7035

BIN CART

CARRELLI COMPONENTI MULTIUSO SERIE PRO+



Il carrello Bin Cart è caratterizzato da una **struttura base composta da telaio e montanti biasolati** che può essere allestita con una **vasta gamma di componenti** per adattarlo a seconda delle necessità dell'operatore. Ripiani, pannelli forati, supporti, ganci e profili per contenitori trasformano Bin Cart in carrelli per picking magazzino, porta pneumatici, 5S Lean Production, portaminuteria, rastrelliera, per imbracature e molto altro. Sono disponibili in **tre diverse larghezze** (700, 1000 o 1500 mm), **due altezze** (1201 e 1809 mm) e possono presentare ruote in gomma standard, gomma antitraccia sintetica o gomma elastica.

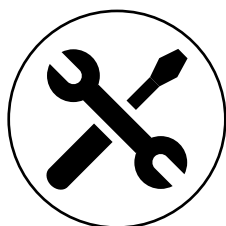

**FACILI DA
MONTARE**



**PORTATA
CARRELLO 300 KG**

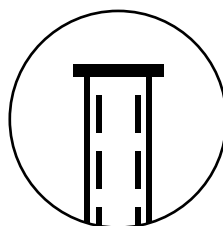

**MONTANTE
FORATO PASSO 38
MM**

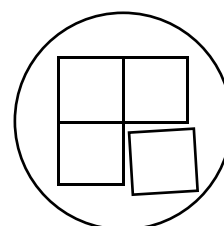



COMPONIBILI

BIN CART



CARRELLO CON 192 PICKING BOX AIR

ART.	L mm	P mm	H mm	KG	colore contenitori	RAL	€
 BINCART1050	1067	668	1384	300		7016	573,90
 BINCART1051	1067	668	1384	300		7016	573,90
 BINCART1052	1067	668	1384	300		7016	573,90
 BINCART1053	1067	668	1384	300		7016	573,90
 BINCART1054	1067	668	1384	300		7016	573,90
 BINCART1055	1067	668	1384	300		7016	573,90

Completo di:

qtà	descrizione
192	Contenitore in polipropilene Picking Box Air mis. 1

[CONFIGURE](#) 



CARRELLO CON 120 PICKING BOX AIR

ART.	L mm	P mm	H mm	KG	colore contenitori	RAL	€
 BINCART1056	1067	668	1384	300		7016	552,30
 BINCART1057	1067	668	1384	300		7016	552,30
 BINCART1058	1067	668	1384	300		7016	552,30
 BINCART1059	1067	668	1384	300		7016	552,30
 BINCART1060	1067	668	1384	300		7016	552,30
 BINCART1061	1067	668	1384	300		7016	552,30

Completo di:

qtà	descrizione
48	Contenitore in polipropilene Picking Box Air mis. 1
72	Contenitore in polipropilene Picking Box Air mis. 2

[CONFIGURE](#) 



CARRELLO CON 100 PICKING BOX AIR

ART.	L mm	P mm	H mm	KG	colore contenitori	RAL	€
 BINCART1062	1067	668	1384	300		7016	533,40
 BINCART1063	1067	668	1384	300		7016	533,40
 BINCART1064	1067	668	1384	300		7016	533,40
 BINCART1065	1067	668	1384	300		7016	533,40
 BINCART1066	1067	668	1384	300		7016	533,40
 BINCART1067	1067	668	1384	300		7016	533,40

Completo di:

qtà	descrizione
48	Contenitore in polipropilene Picking Box Air mis. 1
36	Contenitore in polipropilene Picking Box Air mis. 2
16	Contenitore in polipropilene Picking Box Air mis. 3A2

[CONFIGURE](#) 



PORTATA



RAL 7016



CARRELLO CON 132 PICKING BOX AIR

ART.	L mm	P mm	H mm	KG	colore contenitori	RAL	€
BINCART1068	1067	668	1384	300		7016	514,20
BINCART1069	1067	668	1384	300		7016	514,20
BINCART1070	1067	668	1384	300		7016	514,20
BINCART1071	1067	668	1384	300		7016	514,20
BINCART1072	1067	668	1384	300		7016	514,20
BINCART1073	1067	668	1384	300		7016	514,20

Completo di:

qtà	descrizione
96	Contenitore in polipropilene Picking Box Air mis. 1
36	Contenitore in polipropilene Picking Box Air mis. 2

[CONFIGURE](#)



CARRELLO CON 48 PICKING BOX AIR

ART.	L mm	P mm	H mm	KG	colore contenitori	RAL	€
BINCART1074	1067	668	1384	300		7016	533,70
BINCART1075	1067	668	1384	300		7016	533,70
BINCART1076	1067	668	1384	300		7016	533,70
BINCART1077	1067	668	1384	300		7016	533,70
BINCART1078	1067	668	1384	300		7016	533,70
BINCART1079	1067	668	1384	300		7016	533,70

Completo di:

qtà	descrizione
48	Contenitore in polipropilene Picking Box Air mis. 3A2

[CONFIGURE](#)



CARRELLO CON VISUAL BOX CON RUOTE

ART.	L mm	P mm	H mm	KG	colore cassettiere	RAL	€
BINCART0701	761	668	1357	300		7016	640,80
BINCART0710	761	668	1384	300		7016	641,40

Completo di:

qtà	descrizione
2	Cassettiere Visual Box con 3 cassetti
2	Cassettiere Visual Box con 4 cassetti
4	Cassettiere Visual Box con 5 cassetti
6	Cassettiere Visual Box con 6 cassetti

[CONFIGURE](#)



BIN CART



ART.	L mm	P mm	H mm	KG senza ruote	KG set ruote	RAL	€
 BINCART1007	1067	668	1543	300	300	7016	447,90

Composto da:

qtà	descrizione
1	Carrello smontato senza ruote
1	Coppia piastre di supporto per profilo in alluminio
3	Profilo in alluminio
1	Pannello forato/mensola con 1 bordo fermacasse
1	Pensile con porta
3	Barra aggancio per contenitori Picking Box mis. 1/2
3	Kit 4 contenitori Picking Box Air mis. 1
1	Kit ruote in gomma antitraccia sintetica Ø 125 mm

[CONFIGURE](#) 



ART.	L mm	P mm	H mm	KG senza ruote	KG set ruote	RAL	€
 BINCART1006	1067	668	1965	300	300	7016	386,70

Composto da:

qtà	descrizione
1	Carrello smontato senza ruote
2	Coppia piastre di supporto per profilo in alluminio
6	Profilo in alluminio
1	Kit ruote in gomma antitraccia sintetica Ø 125 mm

[CONFIGURE](#) 



PORTATA



RAL 7016

BIN CART



ART.	L mm	P mm	H mm	senza ruote	set ruote	RAL	€
BINCART0704	761	668	1357	300	300	7016	356,40

Composto da:

qtà	descrizione
1	Carrello smontato senza ruote
4	Pannello forato/mensola con 1 bordo fermacasse
2	Kit staffe per fissaggio pannelli a parete
1	Kit ruote in gomma antitraccia sintetica Ø 125 mm

[CONFIGURE](#)



ART.	L mm	P mm	H mm	senza ruote	set ruote	RAL	€
BINCART1008	1067	668	1357	300	300	7016	387,30

Composto da:

qtà	descrizione
1	Carrello smontato senza ruote
4	Pannello forato/mensola con 1 bordo fermacasse
2	Kit staffe per fissaggio pannelli a parete
1	Kit ruote in gomma antitraccia sintetica Ø 125 mm

[CONFIGURE](#)



ART.	L mm	P mm	H mm	senza ruote	set ruote	RAL	€
BINCART1501	1552	668	1357	300	300	7016	444,00



Composto da:

qtà	descrizione
1	Carrello smontato senza ruote
4	Pannello forato/mensola con 1 bordo fermacasse
2	Kit staffe per fissaggio pannelli a parete
1	Kit ruote in gomma antitraccia sintetica Ø 125 mm

[CONFIGURE](#)

BIN CART





ART.	L mm	P mm	H mm	 senza ruote	 set ruote	RAL	€
 BINCART0705	761	668	1965	300	300	7016	476,70

Composto da:

qtà	descrizione
1	Carrello smontato senza ruote
6	Pannello forato/mensola con 1 bordo fermacasse
3	Kit staffe per fissaggio pannelli a parete
1	Kit ruote in gomma antitraccia sintetica Ø 125 mm

[CONFIGURE](#) 





ART.	L mm	P mm	H mm	 senza ruote	 set ruote	RAL	€
 BINCART1009	1067	668	1965	300	300	7016	518,40

Composto da:

qtà	descrizione
1	Carrello smontato senza ruote
6	Pannello forato/mensola con 1 bordo fermacasse
3	Kit staffe per fissaggio pannelli a parete
1	Kit ruote in gomma antitraccia sintetica Ø 125 mm

[CONFIGURE](#) 



ART.	L mm	P mm	H mm	 senza ruote	 set ruote	RAL	€
 BINCART1502	1552	668	1965	300	300	7016	584,40

Composto da:

qtà	descrizione
1	Carrello smontato senza ruote
6	Pannello forato/mensola con 1 bordo fermacasse
3	Kit staffe per fissaggio pannelli a parete
1	Kit ruote in gomma antitraccia sintetica Ø 125 mm

[CONFIGURE](#) 



PORTATA



RAL 7016

BIN CART



ART.	L mm	P mm	H mm	senza ruote	set ruote	RAL	€
BINCART0706	761	668	1965	300	300	7016	403,80

Composto da:

qtà	descrizione
1	Carrello smontato senza ruote
2	Pannello forato/mensola con 1 bordo fermacasse
1	Kit staffe per fissaggio pannelli a parete
1	Profilo in alluminio
10	Gancio porta cavi P=171 mm
1	Kit ruote in gomma antitraccia sintetica Ø 125 mm

[CONFIGURE](#)



ART.	L mm	P mm	H mm	senza ruote	set ruote	RAL	€
BINCART1010	1067	668	1965	300	300	7016	426,90

Composto da:

qtà	descrizione
1	Carrello smontato senza ruote
2	Pannello forato/mensola con 1 bordo fermacasse
1	Kit staffe per fissaggio pannelli a parete
1	Profilo in alluminio
10	Gancio porta cavi P=171 mm
1	Kit ruote in gomma antitraccia sintetica Ø 125 mm

[CONFIGURE](#)



ART.	L mm	P mm	H mm	senza ruote	set ruote	RAL	€
BINCART1503	1552	668	1965	300	300	7016	470,40

Composto da:

qtà	descrizione
1	Carrello smontato senza ruote
2	Pannello forato/mensola con 1 bordo fermacasse
1	Kit staffe per fissaggio pannelli a parete
1	Profilo in alluminio
10	Gancio porta cavi P=171 mm
1	Kit ruote in gomma antitraccia sintetica Ø 125 mm

[CONFIGURE](#)



BIN CART



ART.	L mm	P mm	H mm	senza ruote	set ruote	RAL	€
BINCART0707	761	668	1357	300	300	7016	283,50

Composto da:

qtà	descrizione
1	Carrello smontato senza ruote
1	Profilo in alluminio
10	Gancio porta cavi P=171 mm
1	Kit ruote in gomma antitraccia sintetica Ø 125 mm

[CONFIGURE](#)



ART.	L mm	P mm	H mm	senza ruote	set ruote	RAL	€
BINCART1011	1067	668	1357	300	300	7016	295,80

Composto da:

qtà	descrizione
1	Carrello smontato senza ruote
1	Profilo in alluminio
10	Gancio porta cavi P=171 mm
1	Kit ruote in gomma antitraccia sintetica Ø 125 mm

[CONFIGURE](#)



Attrezzatura esclusa



ART.	L mm	P mm	H mm	senza ruote	set ruote	RAL	€
BINCART1504	1552	668	1357	300	300	7016	330,00

Composto da:

qtà	descrizione
1	Carrello smontato senza ruote
1	Profilo in alluminio
10	Gancio porta cavi P=171 mm
1	Kit ruote in gomma antitraccia sintetica Ø 125 mm

[CONFIGURE](#)



PORTATA



RAL 7016

BIN CART



ART.	L mm	P mm	H mm	senza ruote	set ruote	RAL	€
BINCART0708	761	668	1357	300	300	7016	408,00

Composto da:

qtà	descrizione
1	Carrello smontato senza ruote
2	Profilo in alluminio
6	Coppia supporti P=266 mm
1	Kit ruote in gomma antitraccia sintetica Ø 125 mm

[CONFIGURE](#)



ART.	L mm	P mm	H mm	senza ruote	set ruote	RAL	€
BINCART1012	1067	668	1357	300	300	7016	424,50

Composto da:

qtà	descrizione
1	Carrello smontato senza ruote
2	Profilo in alluminio
6	Coppia supporti P=266 mm
1	Kit ruote in gomma antitraccia sintetica Ø 125 mm

[CONFIGURE](#)



Attrezzatura esclusa



ART.	L mm	P mm	H mm	senza ruote	set ruote	RAL	€
BINCART1505	1552	668	1357	300	300	7016	468,60

Composto da:

qtà	descrizione
1	Carrello smontato senza ruote
2	Profilo in alluminio
6	Coppia supporti P=266 mm
1	Kit ruote in gomma antitraccia sintetica Ø 125 mm

[CONFIGURE](#)



BIN CART



ART.	L mm	P mm	H mm	senza ruote	set ruote	RAL	€
BINCART0709	761	668	1965	300	300	7016	458,40

Composto da:

qtà	descrizione
1	Carrello smontato senza ruote
1	Pannello forato/mensola con 1 bordo fermacasse
1	Kit porta rotolo con carta Ø=240 mm
1	Mensola piccola reversibile
2	Profilo in alluminio
3	Coppia supporti P=421 mm
1	Kit ruote in gomma antitraccia sintetica Ø 125 mm

[CONFIGURE](#)



ART.	L mm	P mm	H mm	senza ruote	set ruote	RAL	€
BINCART1013	1067	668	1965	300	300	7016	616,20

Composto da:

qtà	descrizione
1	Carrello smontato senza ruote
1	Pannello forato/mensola con 1 bordo fermacasse
2	Pensile con porta
2	Profilo in alluminio
3	Coppia supporti P=421 mm
1	Kit ruote in gomma antitraccia sintetica Ø 125 mm

[CONFIGURE](#)



ART.	L mm	P mm	H mm	senza ruote	set ruote	RAL	€
BINCART1506	1552	668	1965	300	300	7016	606,30

Composto da:

qtà	descrizione
1	Carrello smontato senza ruote
1	Pannello forato/mensola con 1 bordo fermacasse
1	Pensile con porta
2	Mensola grande reversibile
2	Profilo in alluminio
3	Coppia supporti P=421 mm
1	Kit ruote in gomma antitraccia sintetica Ø 125 mm

[CONFIGURE](#)



PORTATA



RAL 7016

BIN CART



CONFIGURE 

PATENTED



ART.	L mm	P mm	H mm	 senza ruote	 set ruote	RAL	€
BINCART1005	1067	668	1677	300	300	7016	469,50

Composto da:

qtà	descrizione
1	Carrello smontato senza ruote
3	Pannello non forato/mensola
1	Pannello forato/mensola con 1 bordo fermacasse
1	Coppia squadrette a L
1	Snodo per piastra

qtà	descrizione
1	Piastra porta monitor con standard VESA
1	Supporto multipresa a 4 scomparti
1	Multipresa schuko a 4 scomparti
1	Cavo di collegamento wieland schuko/francese
1	Kit ruote in gomma antitraccia sintetica Ø 125 mm



BIN CART



CONFIGURE 

Contenitori esclusi



ART.	L mm	P mm	H mm	 senza ruote	 set ruote	RAL	€
 BINCART1004	1067	668	1357	300	300	7016	331,50

Composto da:

qtà	descrizione
1	Carrello smontato senza ruote
3	Pannello forato/mensola con 1 bordo fermacasse
1	Profilo in alluminio
1	Kit ruote in gomma antitraccia sintetica Ø 125 mm



PORTATA



RAL 7016



[CONFIGURE](#)

Banco escluso



ART.	L mm	P mm	H mm	senza ruote	set ruote	RAL	€
BINCART1014	2513	850	2267	300	300	7016	1056,90

Composto da:

qtà	descrizione
1	Carrello smontato senza ruote
1	Kit 2 supporti inclinati con binario
1	Lampada doppia
3	Pannello forato/mensola con 1 bordo fermacasse
4	Kit 2 contenitori Picking Box Air mis. 3A2
2	Braccio estensibile per montante
1	Kit ruote in gomma antitraccia sintetica Ø 125 mm

qtà	descrizione
2	Piastra porta monitor con standard VESA
1	Pannello per Picking Box
5	Barra aggancio per contenitori Picking Box mis. 1/2
5	Kit 4 contenitori Picking Box Air mis. 1
1	Pannello per Visual Box
2	Cassettiera Visual Box con 6 cassetti
1	Cassettiera Visual Box con 5 cassetti
1	Kit ruote in gomma antitraccia sintetica Ø 125 mm

BIN CART



[CONFIGURE](#)

Banco escluso

ART.	L mm	P mm	H mm	senza ruote	set ruote	RAL	€
BINCART1507	2998	850	2267	300	300	7016	1122,90

Composto da:

qtà	descrizione
1	Carrello smontato senza ruote
3	Pannello forato/mensola con 1 bordo fermacasse
1	Kit 2 supporti inclinati con binario
1	Lampada doppia
2	Braccio estensibile per montante
2	Piastra porta monitor con standard VESA
1	Pannello per Picking Box

qtà	descrizione
4	Barra aggancio per contenitori Picking Box mis. 1/2
4	Kit 4 contenitori Picking Box Air mis. 1
1	Pannello per Visual Box
2	Cassettiera Visual Box con 6 cassetti
1	Cassettiera Visual Box con 5 cassetti
36	Contenitore in polipropilene Picking Box Air mis. 2
1	Kit ruote in gomma antitraccia sintetica Ø 125 mm



PORTATA



RAL 7016

BIN CART

COMPONENTI

L ➔ 700 mm



CARRELLO SMONTATO SENZA RUOTE

ART.	L mm	P mm	H mm	KG	per lato	RAL	€
 FBC10070039	709	668	1201	300	150	7016	121,20
 FBC15070039	709	668	1809	300	150	7016	150,60

PROFILO IN ALLUMINIO

ART.	L mm	P mm	H mm	KG	materiale	€
 FBC25070000	705	35	60	40	Alluminio	15,90



COPPIA SUPPORTI PARZIALI PER VISUAL BOX

ART.	L mm	P mm	H mm	KG	RAL	€
 FBC30070139	649	50	319	75	7016	24,30



COPPIA SUPPORTI TOTALI PER VISUAL BOX

ART.	L mm	P mm	H mm	KG	RAL	€
 FBC30070239	649	50	1153	150	7016	41,70



BIN CART

COMPONENTI

L → 700 mm



PANNELLO NON FORATO/MENSOLA

Può essere utilizzato come chiusura della base del carrello

ART.	L mm	P mm	H mm	KG	RAL	€
FBL76580008	647	31	494	50	7035	38,40



PANNELLO FORATO/MENSOLA CON 1 BORDO FERMACASSE

ART.	L mm	P mm	H mm	Dim. foro mm	Passo mm	RAL	€
FBL76080108	647	40	456	10x10	38	7035	37,20
FBL76080104	647	40	456	10x10	38	5012	37,20

VISUAL BOX



CASSETTIERA VISUAL BOX

ART.	multiplo d'ordine	dim. ingombro			cassetti				colore	€
		L mm	P mm	H mm	n.	L mm	P mm	H mm		
FAXVBCH00900001	1	600	68	78	9	56	43	47	Grigio scuro	12,60
FAXVBCH00600001	1	600	96	112	6	88	65	70	Grigio scuro	14,70
FAXVBCH00500001	1	600	140	168	5	108	98	107	Grigio scuro	23,40
FAXVBCH00400001	1	600	178	206	4	138	127	134	Grigio scuro	32,40
FAXVBCH00300001	1	600	210	242	3	180	145	161	Grigio scuro	39,60



FERMO PER CASSETTIERA VISUAL BOX

ART.	adatto per	€
FAXVBCHL0900099	FAXVBCH009000	1,80
FAXVBCHL0600099	FAXVBCH006000	1,80
FAXVBCHL0500099	FAXVBCH005000	1,80
FAXVBCHL0400099	FAXVBCH004000	1,80
FAXVBCHL0300099	FAXVBCH003000	1,80



PORTATA



RAL 5012



RAL 7016



RAL 7035





ALLUMINIO

COMPONENTI

L ➔ 1000 mm



CARRELLO SMONTATO SENZA RUOTE

ART.	L mm	P mm	H mm	KG	KG per lato	RAL	€
 FBC10100039	1015	668	1201	300	150	7016	129,30
 FBC15100039	1015	668	1809	300	150	7016	158,10

PROFILO IN ALLUMINIO

ART.	L mm	P mm	H mm	KG	materiale	€
 FBC25100000	1011	35	60	40	Alluminio	20,10



PROFILO IN ALLUMINIO PER PICKING BOX AIR

ART.	L mm	P mm	H mm	KG	materiale	€
 FBC25100300	1011	35	118	80	Alluminio	20,10





PANNELLO NON FORATO/MENSOLA

Può essere utilizzato come chiusura della base del carrello

ART.	L mm	P mm	H mm	KG	RAL	€
 FBL76680008	953	31	494	50	7035	47,10

PANNELLO FORATO/MENSOLA CON 1 BORDO FERMACASSE

ART.	L mm	P mm	H mm	Dim. foro mm	Passo mm	RAL	€
 FBL76170108	953	40	456	10x10	38	7035	42,90
 FBL76170104	953	40	456	10x10	38	5012	42,90



BIN CART





COMPONENTI

L → 1000 mm



1

CONTENITORE CON FONDO RINFORZATO

ART.	multiplo d'ordine	mis.	dim.ingombro			L	colore	€
			L mm	P mm	H mm			
 FPB0001R051LQ	48	1	108	173	76	1		1,20
 FPB0001R05139	48	1	108	173	76	1		1,20
 FPB0001R05132	48	1	108	173	76	1		1,20
 FPB0001R0511Z	48	1	108	173	76	1		1,20
 FPB0001R0512Y	48	1	108	173	76	1		1,20
 FPB0001R0514Q	48	1	108	173	76	1		1,20



2













CONTENITORE CON FONDO RINFORZATO

ART.	multiplo d'ordine	mis.	dim.ingombro			L	colore	€
			L mm	P mm	H mm			
 FPB0002R051LQ	36	2	160	234	127	3,8		2,10
 FPB0002R05139	36	2	160	234	127	3,8		2,10
 FPB0002R05132	36	2	160	234	127	3,8		2,10
 FPB0002R0511Z	36	2	160	234	127	3,8		2,10
 FPB0002R0512Y	36	2	160	234	127	3,8		2,10
 FPB0002R0514Q	36	2	160	234	127	3,8		2,10



3A2

CONTENITORE CON FONDO RINFORZATO

ART.	multiplo d'ordine	mis.	dim.ingombro			L	colore	€
			L mm	P mm	H mm			
 FPB03A2R051LQ	16	3A2	224	354	147	9,4		4,80
 FPB03A2R05139	16	3A2	224	354	147	9,4		4,80
 FPB03A2R05132	16	3A2	224	354	147	9,4		4,80
 FPB03A2R0511Z	16	3A2	224	354	147	9,4		4,80
 FPB03A2R0512Y	16	3A2	224	354	147	9,4		4,80
 FPB03A2R0514Q	16	3A2	224	354	147	9,4		4,80



COPPIA PIASTRE DI SUPPORTO PER PROFILO IN ALLUMINIO

ART.	L mm	P mm	H mm	KG	RAL	€
 FBC40100039	524	104	3	80	7016	27,30

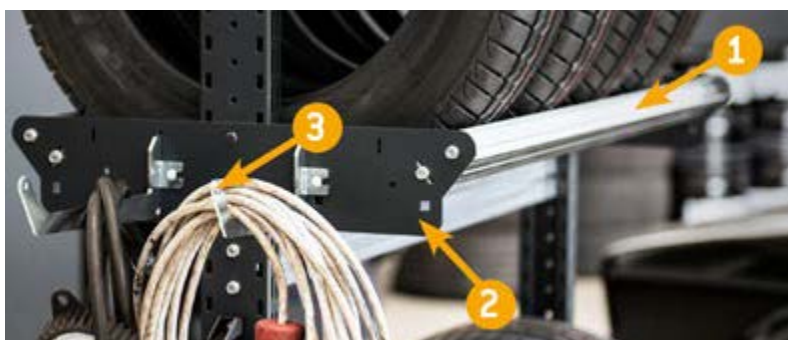

1. Profilo in alluminio
2. Coppia piastre di supporto per profilo in alluminio
3. Gancio porta cavi P=221 mm



PORTATA



RAL 5012



RAL 7016



RAL 7035



ALLUMINIO

COMPONENTI

L ➔ 1500 mm



CARRELLO SMONTATO SENZA RUOTE

ART.	L mm	P mm	H mm	KG	KG per lato	RAL	€
 FBC10150039	1500	668	1201	300	150	7016	153,60
 FBC15150039	1500	668	1809	300	150	7016	175,50



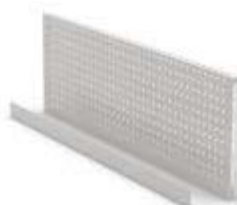

PROFILO IN ALLUMINIO

ART.	L mm	P mm	H mm	KG	materiale	€
 FBC25150000	1496	35	60	40	Alluminio	30,00



PANNELLO FORATO/MENSOLA CON 1 BORDO FERMACASSE

ART.	L mm	P mm	H mm	Dim. foro mm	Passo mm	RAL	€
 FBL76320108	1438	40	456	10x10	38	7035	51,00
 FBL76320104	1438	40	456	10x10	38	5012	51,00



BIN CART

COMPONENTI

L → 700 - 1000 - 1500 mm



GANCIO PORTA CAVI

ART.	L mm	P mm	H mm	KG	€
FBC35100099	28	171	84	10	9,30
FBC35150099	28	221	84	10	9,60
FBC35200099	28	271	84	10	10,20



COPPIA SUPPORTI

ART.	dim. ingombro			dim. utili	KG	RAL	€
	L mm	P mm	H mm	P mm			
FBC45030008	36	300	136	266	70	7035	33,60
FBC45040008	36	455	136	421	50	7035	37,20



KIT RUOTE

ART.	Ø mm	KG set ruote	H mm	materiale			€
FKRD1002107	100	225	128	Gomma standard	2	2	44,10
FKRB1252107	125	300	155	Gomma standard	2	2	48,90
FKRU1252101	125	300	155	Gomma antitraccia sintetica	2	2	53,40
FKRS1252101	125	750	155	Gomma elastica	2	2	85,20

IRON TEAM

vedi pag. 196



FBLIT020099
FBLIT0610LQ



FBL95410000



FBLIT008039



FBLIT004039



FBLIT010039



FBLIT017039



FBLET012007



FBLET004007



FBLET005007



FBLET016007



PORTATA



RUOTA FISSA



RUOTA GIREVOLE CON FRENO



RAL 5012



RAL 7016



RAL 7035



ALLUMINIO

GEAR GARAGE







CARATTERISTICHE

TUTTO PARTE DAL PIANO

I moduli inferiori dispongono di un piano di lavoro di profondità 630 mm che consente di disporre di spazi ampi per poter lavorare in comodità.

LO SCORRERE DELL'ANTA

Gli armadi ad ante scorrevoli aumentano la capacità di stoccaggio della postazione di lavoro riducendo gli ingombri e gli ostacoli che deriverebbero dall'utilizzo di armadi ad ante a battente.



Courtesy of Trident Motorsport



L'ARMADIO SEGRETO

L'armadio tecnico è ideato per celare all'interno rulli per arrotolatori e cavi elettrici, così da rendere visibili solo i componenti necessari per il lavoro.



IL BASCULANTE DEL GARAGE

Aperture basculanti possono essere inserite nei moduli inferiori per sfruttare spazi che altrimenti sarebbero inutilizzati. Facilitano la differenziazione dei rifiuti, contribuendo a mantenere la postazione di lavoro pulita e in ordine.



DIETRO L'ANGOLO

Il modulo ad angolo può essere arricchito con un massimo di 4 prese elettriche e 2 arrotolatori. Permette di sfruttare al massimo gli spazi e di disporre di un piano di lavoro di notevoli dimensioni.





IL CASSETTO DELLE MERAVIGLIE

Estrazione del 100% e portata di 70 kg rendono i cassetti la custodia ideale per attrezzatura e utensili per il lavoro. L'estrazione totale permette di avere una visuale completa dell'interno e facilita il prelievo del materiale stoccato.



AUTOPORTANTE

Tutte le soluzioni che compongono Gear Garage non necessitano di fissaggio a muro. Le diverse strutture come moduli e pensili sono autoportanti.



STOCCAGGIO SOSPESO

Il pensile con apertura a Vasistas silenziosa può essere installato a muro oppure su parete forata e permette di avere a disposizione un ulteriore luogo per l'organizzazione del materiale di lavoro.

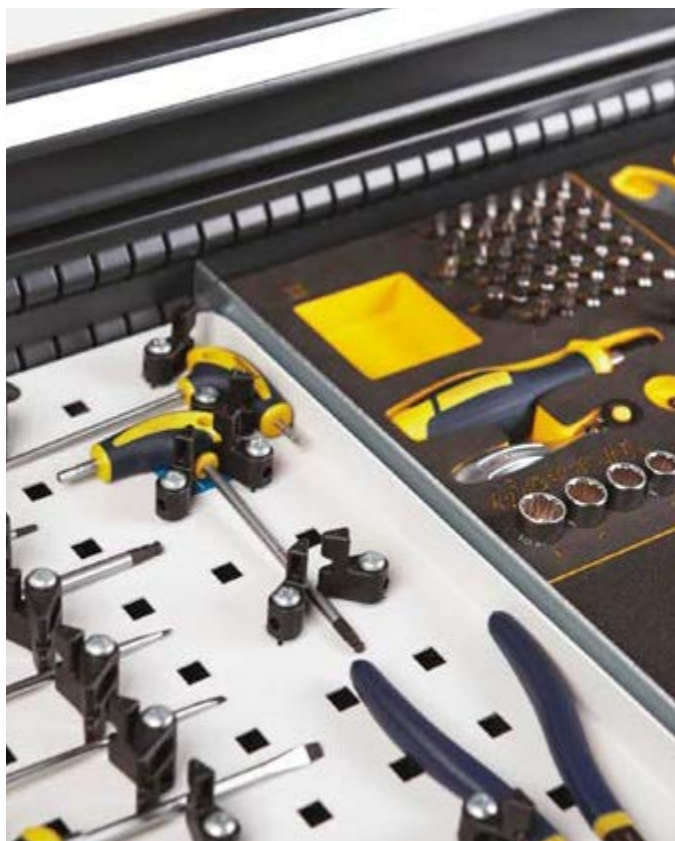

MODULI

Il sistema modulare di Gear Garage permette l'integrazione di più moduli per creare strutture che possono adattarsi facilmente alle dimensioni dell'ambiente in cui devono essere installate. I moduli sono disponibili in 7 diverse larghezze, da un minimo di 512 mm ad un massimo di 2040 mm, e si suddividono in moduli base, piani di lavoro, pensili, armadi, cassettiere e angolari.

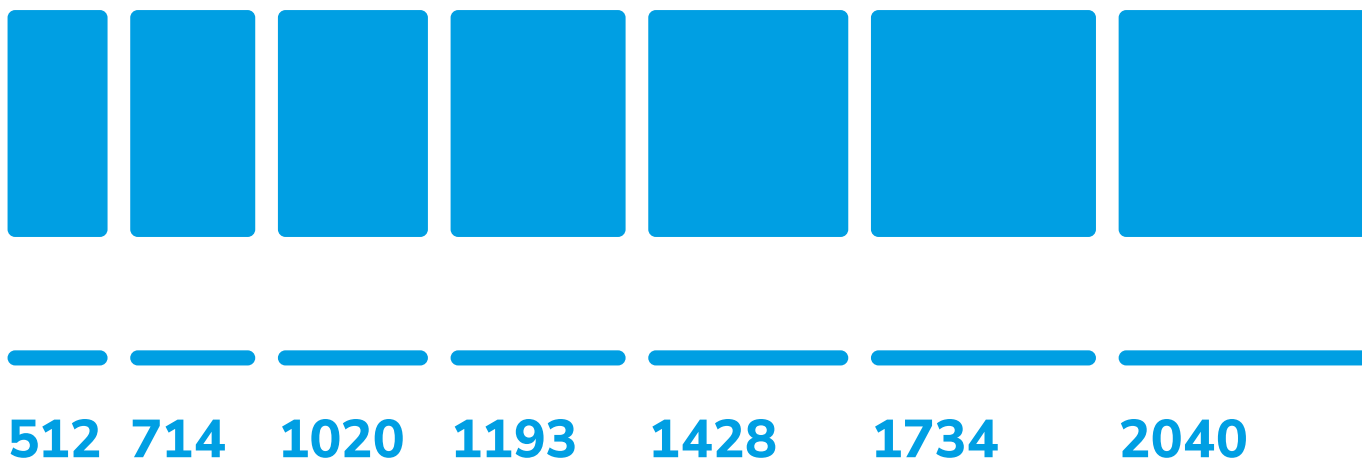

TOP IN VARIE TIPOLOGIE



Acciaio **inox** satinato



Acciaio **gommato**



Legno **multiplex**

GARANZIA



I 10 anni di garanzia dei prodotti Fami sono la diretta espressione dell'utilizzo di materiali di qualità, della cura e dedizione nella produzione per rendere i nostri arredi affidabili e durevoli nel tempo.



Courtesy of Trident Motorsport

TUTTI I COLORI PIÙ UNO!

In base all'ambiente in cui è installato o in base ai colori aziendali, Gear Garage può essere monocolore o bicolore. Sono a disposizione, infatti, fino a 12 colori RAL per personalizzare la struttura e i frontali.

STRUTTURA

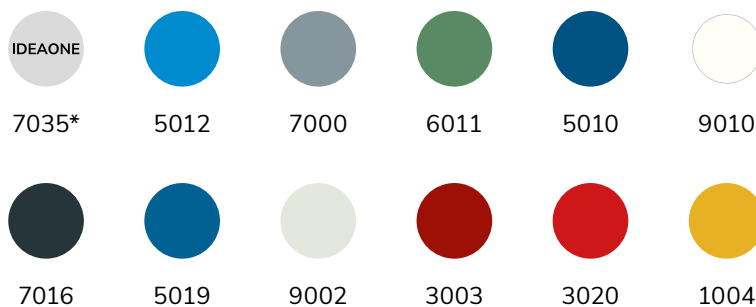

FRONTALI

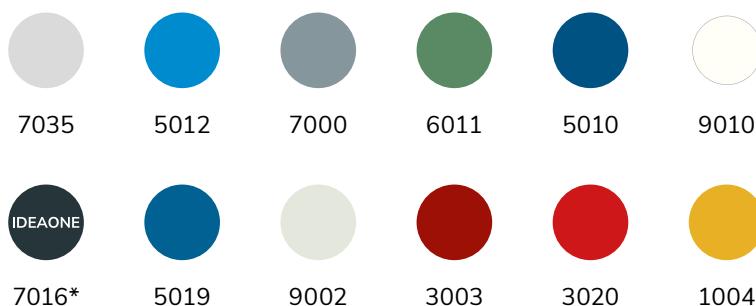

*La struttura e i frontali nei colori **Ideaone** RAL 7035 + RAL 7016 sono pronti a magazzino.



CONFIGURE

ART.	L mm	P mm	H mm	Top	RAL	€
GARAGE086	3306	2694	2000	Inox satinato	7035+7016	7648,50
GARAGE087	3306	2694	2000	Acciaio gommato	7035+7016	7566,00





CONFIGURE

ART.	L mm	P mm	H mm	Top	RAL	€
GARAGE090	3063	640	2000	Inox satinato	7035+7016	4133,70
GARAGE091	3063	640	2000	Acciaio gommato	7035+7016	4100,40

[CONFIGURE](#)

ART.	Lmm	Pmm	Hmm	Top	RAL	€
GARAGE088	8976	640	2000	Inox satinato	7035+7016	10401,00
GARAGE089	8976	640	2000	Acciaio gommato	7035+7016	10301,10

[CONFIGURE](#)

ART.	Lmm	Pmm	Hmm	Top	RAL	€
GARAGE104	2757	640	2000	Inox satinato	7035+7016	3363,30
GARAGE105	2757	640	2000	Acciaio gommato	7035+7016	3316,50





[CONFIGURE](#)

ART.	L mm	P mm	H mm	Top	RAL	€
GARAGE094	1940	640	2000	Inox satinato	7035+7016	2500,20
GARAGE095	1940	640	2000	Acciaio gommato	7035+7016	2466,90

[CONFIGURE](#)

ART.	Lmm	Pmm	Hmm	Top	RAL	€
GARAGE106	5515	640	2000	Inox satinato	7035+7016	8274,30
GARAGE107	5515	640	2000	Acciaio gommato	7035+7016	8180,70

[CONFIGURE](#)

ART.	Lmm	Pmm	Hmm	Top	RAL	€
GARAGE096	1940	640	2000	Inox satinato	7035+7016	2640,90
GARAGE097	1940	640	2000	Acciaio gommato	7035+7016	2607,60





[CONFIGURE](#)

ART.	L mm	P mm	H mm	Top	RAL	€
GARAGE092	2142	640	2000	Inox satinato	7035+7016	3360,60
GARAGE093	2142	640	2000	Acciaio gommato	7035+7016	3282,00



CONFIGURE

ART.	Lmm	Pmm	Hmm	Top	RAL	€
GARAGE110	5712	640	2000	Inox satinato	7035+7016	7904,70
GARAGE111	5712	640	2000	Acciaio gommato	7035+7016	7771,50



CONFIGURE

ART.	Lmm	Pmm	Hmm	Top	RAL	€
GARAGE098	1428	640	2000	Inox satinato	7035+7016	2054,10
GARAGE099	1428	640	2000	Acciaio gommato	7035+7016	2020,80





CONFIGURE

ART.	L mm	P mm	H mm	Top	RAL	€
GARAGE100	2041	640	2000	Inox satinato	7035+7016	2337,00
GARAGE101	2041	640	2000	Acciaio gommato	7035+7016	2303,70



[CONFIGURE](#)

ART.	Lmm	Pmm	Hmm	Top	RAL	€
GARAGE108	5508	640	2000	Inox satinato	7035+7016	7706,10
GARAGE109	5508	640	2000	Acciaio gommato	7035+7016	7612,50



[CONFIGURE](#)

ART.	Lmm	Pmm	Hmm	Top	RAL	€
GARAGE102	2041	640	2000	Inox satinato	7035+7016	2621,10
GARAGE103	2041	640	2000	Acciaio gommato	7035+7016	2587,80



**7 GEAR
GARAGE**







3D

MODULO - DIM. (mm): L=714 P=640 H=2000

ART.	Top	RAL	€
GARAGE001	Inox satinato	7035+7016	1462,80
GARAGE002	Acciaio gommato	7035+7016	1417,50



3D

MODULO - DIM. (mm): L=714 P=640 H=2000

ART.	Top	RAL	€
GARAGE003	Inox satinato	7035+7016	1198,20
GARAGE004	Acciaio gommato	7035+7016	1152,90



3D

MODULO - DIM. (mm): L=714 P=640 H=2000

ART.	Top	RAL	€
GARAGE005	Inox satinato	7035+7016	1281,30
GARAGE006	Acciaio gommato	7035+7016	1236,00



3D

MODULO - DIM. (mm): L=714 P=640 H=2000

ART.	RAL	€
GARAGE007	7035+7016	1579,20



3D

MODULO - DIM. (mm): L=714 P=640 H=2000

ART.	Top	RAL	€
GARAGE008	Inox satinato	7035+7016	1384,80
GARAGE009	Acciaio gommato	7035+7016	1339,50



3D

MODULO - DIM. (mm): L=714 P=640 H=2000

ART.	Top	RAL	€
GARAGE010	Inox satinato	7035+7016	1338,90
GARAGE011	Acciaio gommato	7035+7016	1293,60



3D

MODULO - DIM. (mm): L=1020 P=640 H=2000

ART.	Top	RAL	€
GARAGE012	Inox satinato	7035+7016	1655,70
GARAGE013	Acciaio gommato	7035+7016	1639,80



3D

MODULO - DIM. (mm): L=1020 P=640 H=2000

ART.	Top	RAL	€
GARAGE014	Inox satinato	7035+7016	1600,20
GARAGE015	Acciaio gommato	7035+7016	1584,30



3D

MODULO - DIM. (mm): L=1020 P=640 H=2000

ART.	Top	RAL	€
GARAGE016	Inox satinato	7035+7016	1334,70
GARAGE017	Acciaio gommato	7035+7016	1318,80



3D

MODULO - DIM. (mm): L=1020 P=640 H=2000

ART.	Top	RAL	€
GARAGE018	Inox satinato	7035+7016	1426,80
GARAGE019	Acciaio gommato	7035+7016	1410,90



3D

MODULO - DIM. (mm): L=1020 P=640 H=2000

ART.	Top	RAL	€
GARAGE020	Inox satinato	7035+7016	1507,50
GARAGE021	Acciaio gommato	7035+7016	1491,60



3D

MODULO - DIM. (mm): L=1020 P=640 H=2000

ART.	Top	RAL	€
GARAGE022	Inox satinato	7035+7016	1563,60
GARAGE023	Acciaio gommato	7035+7016	1547,70



3D

MODULO - DIM. (mm): L=1428 P=640 H=2000

ART.	Top	RAL	€
GARAGE024	Inox satinato	7035+7016	2021,70
GARAGE025	Acciaio gommato	7035+7016	1988,40



3D

MODULO - DIM. (mm): L=1428 P=640 H=2000

ART.	Top	RAL	€
GARAGE026	Inox satinato	7035+7016	2447,70
GARAGE027	Acciaio gommato	7035+7016	2414,40



3D

MODULO - DIM. (mm): L=1428 P=640 H=2000

ART.	Top	RAL	€
GARAGE028	Inox satinato	7035+7016	2162,40
GARAGE029	Acciaio gommato	7035+7016	2129,10



3D

MODULO - DIM. (mm): L=1428 P=640 H=2000

ART.	Top	RAL	€
GARAGE030	Inox satinato	7035+7016	1624,80
GARAGE031	Acciaio gommato	7035+7016	1591,50



3D

MODULO - DIM. (mm): L=1428 P=640 H=2000

ART.	Top	RAL	€
GARAGE032	Inox satinato	7035+7016	1756,20
GARAGE033	Acciaio gommato	7035+7016	1722,90



3D

MODULO - DIM. (mm): L=1428 P=640 H=2000

ART.	Top	RAL	€
GARAGE034	Inox satinato	7035+7016	2104,80
GARAGE035	Acciaio gommato	7035+7016	2071,50



3D

MODULO - DIM. (mm): L=1734 P=640 H=2000

ART.	Top	RAL	€
GARAGE036	Inox satinato	7035+7016	3138,90
GARAGE037	Acciaio gommato	7035+7016	3092,10



3D

MODULO - DIM. (mm): L=1734 P=640 H=2000

ART.	Top	RAL	€
GARAGE038	Inox satinato	7035+7016	3131,70



3D

MODULO - DIM. (mm): L=1734 P=640 H=2000

ART.	Top	RAL	€
GARAGE039	Inox satinato	7035+7016	2853,60
GARAGE040	Acciaio gommato	7035+7016	2806,80



3D

MODULO - DIM. (mm): L=1734 P=640 H=2000

ART.	Top	RAL	€
GARAGE041	Inox satinato	7035+7016	2748,60
GARAGE042	Acciaio gommato	7035+7016	2701,80



3D

MODULO - DIM. (mm): L=1734 P=640 H=2000

ART.	Top	RAL	€
GARAGE043	Inox satinato	7035+7016	2885,40
GARAGE044	Acciaio gommato	7035+7016	2838,60



3D

MODULO - DIM. (mm): L=1734 P=640 H=2000

ART.	Top	RAL	€
GARAGE045	Inox satinato	7035+7016	2796,00
GARAGE046	Acciaio gommato	7035+7016	2749,20



3D

MODULO - DIM. (mm): L=2040 P=640 H=2000

ART.	Top	RAL	€
GARAGE047	Inox satinato	7035+7016	2888,10
GARAGE048	Acciaio gommato	7035+7016	2854,80



3D

MODULO - DIM. (mm): L=2040 P=640 H=2000

ART.	Top	RAL	€
GARAGE049	Inox satinato	7035+7016	3566,40
GARAGE050	Acciaio gommato	7035+7016	3533,10



3D

MODULO - DIM. (mm): L=2040 P=640 H=2000

ART.	Top	RAL	€
GARAGE051	Inox satinato	7035+7016	2980,20
GARAGE052	Acciaio gommato	7035+7016	2946,90



3D

MODULO - DIM. (mm): L=2040 P=640 H=2000

ART.	Top	RAL	€
GARAGE053	Inox satinato	7035+7016	2535,60
GARAGE054	Acciaio gommato	7035+7016	2502,30



3D

MODULO - DIM. (mm): L=2040 P=640 H=2000

ART.	Top	RAL	€
GARAGE055	Inox satinato	7035+7016	2718,00
GARAGE056	Acciaio gommato	7035+7016	2684,70



3D

MODULO - DIM. (mm): L=2040 P=640 H=2000

ART.	Top	RAL	€
GARAGE057	Inox satinato	7035+7016	3309,60
GARAGE058	Acciaio gommato	7035+7016	3276,30



3D

MODULO - DIM. (mm): L=2040 P=640 H=2000

ART.	Top	RAL	€
GARAGE059	Inox satinato	7035+7016	1998,00
GARAGE060	Acciaio gommato	7035+7016	1964,70



3D

MODULO - DIM. (mm): L=2040 P=640 H=2000

ART.	Top	RAL	€
GARAGE061	Inox satinato	7035+7016	2568,30
GARAGE062	Acciaio gommato	7035+7016	2535,00



3D

MODULO - DIM. (mm): L=2040 P=640 H=2000

ART.	Top	RAL	€
GARAGE063	Inox satinato	7035+7016	3076,50
GARAGE064	Acciaio gommato	7035+7016	3043,20

Courtesy of Trident Motorsport





3D

MODULO - DIM. (mm): L=754 P=754 H=2000

ART.	Top	RAL	€
GARAGE112	Inox satinato	7035+7016	1058,40
GARAGE113	Acciaio gommato	7035+7016	1042,50



3D

MODULO - DIM. (mm): L=714 P=754 H=2000

ART.	Top	RAL	€
GARAGE114	Inox satinato	7035+7016	931,50
GARAGE115	Acciaio gommato	7035+7016	915,60



3D

MODULO - DIM. (mm): L=583 P=600 H=921

ART.	RAL	€
GARAGE116	7035+7016	747,00





ARMADIO CON PORTA A BATTENTE

Coppia tamponi per armadio



3D

PERFOM - DIM. (mm): L=512 P=640 H=2000

ART.	RAL	€
GARAGE065	7035+7016	478,50



3D

PERFOM - DIM. (mm): L=512 P=640 H=2000

ART.	RAL	€
GARAGE066	7035+7016	627,60



vedi pag. 364

ARMADIO CON PORTE A BATTENTE



3D

PERFOM - DIM. (mm): L=1023 P=640 H=2000

ART.	RAL	€
GARAGE068	7035+7016	567,30



3D

PERFOM - DIM. (mm): L=1023 P=640 H=2000

ART.	RAL	€
GARAGE069	7035+7016	786,90



3D

PERFOM - DIM. (mm): L=1023 P=640 H=2000

ART.	RAL	€
GARAGE072	7035+7016	696,90



3D

PERFOM - DIM. (mm): L=1023 P=640 H=2000

ART.	RAL	€
GARAGE073	7035+7016	909,30





ARMADIO CON PORTE SCORREVOLI

Coppia montanti



3D

PERFOM - DIM. (mm): L=1020 P=640 H=2000

ART.	RAL	€
GARAGE074	7035+7016	925,80



3D

PERFOM - DIM. (mm): L=1020 P=640 H=2000

ART.	RAL	€
GARAGE076	7035+7016	1119,00



3D

PERFOM - DIM. (mm): L=1427 P=640 H=2000

ART.	RAL	€
GARAGE077	7035+7016	1183,50



3D

PERFOM - DIM. (mm): L=1427 P=640 H=2000

ART.	RAL	€
GARAGE079	7035+7016	1496,70



ARMADIO CON PORTE SCORREVOLI

Coppia montanti



3D

PERFOM - DIM. (mm): L=2040 P=640 H=2000



ART.	RAL	€
GARAGE080	7035+7016	1539,60



3D

PERFOM - DIM. (mm): L=2040 P=640 H=2000



ART.	RAL	€
GARAGE082	7035+7016	1955,70

ACCESSORI



ARROTOLATORE ELETTRICO CON PRESA SCHUKO



ART.	L cavo m	tipo presa	Volt	Watt	€
MBR13S0V0V00100	20	Schuko	230	1600	533,10



ARROTOLATORE PER ARIA COMPRESSA



ART.	L cavo m	Pressione max Mpa	Ø mm	€
MBR13S0V0V00200	14	1,5	10	244,80



RULLO PER ARROTOLATORE



ART.	€
MBR13S0V0V00339	29,10



PIASTRA PER ARROTOLATORE

Da fissare alla parte posteriore dell'armadio



ART.	€
MBR13S0V0V00499	20,70



1. Armadio tecnico L=560 mm predisposto per porta
2. Modulo: Rullo per arrotolatore

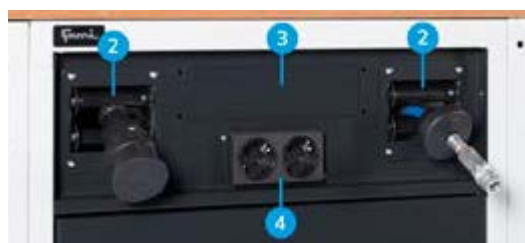

3. Modulo: Multipresa a 4 scomparti
4. Modulo: Multipresa a 2 scomparti

MATERIALE DI SEPARAZIONE
36X27 EH L= 717 mm

ART.	adatto per cassetto H mm	componenti	€
FFH10051000	50/300	3 x Divisorio a 3 canali 9 x Divisorio a 4 canali 12 x Divisorio trasversale L=47 mm 36 x Divisorio trasversale L=36 mm	30,90



ART.	adatto per cassetto H mm	componenti	€
FFH10051300	50/300	18 x Divisorio trasversale L=47 mm 12 x Divisorio trasversale L=73 mm 6 x Divisorio a 2 canali 6 x Divisorio a 3 canali	27,90



ART.	adatto per cassetto H mm	componenti	€
FFH10051500	50/300	20 x Divisorio trasversale L=36 mm 20 x Divisorio trasversale L=47 mm 6 x Divisorio a 3 canali 5 x Divisorio a 4 canali 1 x Porta chiavi a brugola	30,90



ART.	adatto per cassetto H mm	componenti	€
FFH10071800	75	16 x Cassetta divisorio 75x75 mm 8 x Cassetta divisorio 150x75 mm 4 x Cassetta divisorio 150x150 mm	31,50



ART.	adatto per cassetto H mm	componenti	€
FFH10071600	75	12 x Cassetta divisorio 150x75 mm	28,80
FFH10101600	100/125	6 x Cassetta divisorio 150x150 mm	33,60



ART.	adatto per cassetto H mm	componenti	€
FFH10070500	75		15,90
FFH10100500	100/125	2 x Divisorio longitudinale fessurato L=457 mm	16,50
FFH10150500	150/175	3 x Divisorio trasversale L=202 mm	21,90
FFH10200500	200/250		31,20





MATERIALE DI SEPARAZIONE

54X27 EH L= 1023 mm



ART.	adatto per cassetto H mm	componenti	€
FFH40051200	50/300	15 x Divisorio trasversale L=36 mm 10 x Divisorio trasversale L=47 mm 6 x Divisorio trasversale L=73 mm 6 x Divisorio a 2 canali 6 x Divisorio a 3 canali 6 x Divisorio a 4 canali	38,40



ART.	adatto per cassetto H mm	componenti	€
FFH40051500	50/300	30 x Divisorio trasversale L=36 mm 10 x Divisorio trasversale L=47 mm 6 x Divisorio a 3 canali 12 x Divisorio a 4 canali	40,80



ART.	adatto per cassetto H mm	componenti	€
FFH40071100	75	18 x Cassetta divisorio 150x150 mm	41,10
FFH40101100	100/125		46,50



ART.	adatto per cassetto H mm	componenti	€
FFH40071300	75	12 x Cassetta divisorio 150x75 mm 12 x Cassetta divisorio 150x150 mm	42,90
FFH40101300	100/125		49,50



ART.	adatto per cassetto H mm	componenti	€
FFH40071600	75	20 x Cassetta divisorio 75x75 mm 14 x Cassetta divisorio 150x75 mm 6 x Cassetta divisorio 150x150 mm	47,40

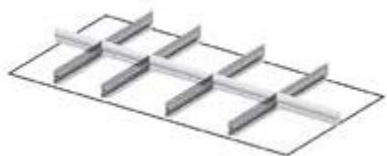

ART.	adatto per cassetto H mm	componenti	€
FFH40070500	75	4 x Divisorio longitudinale fessurato L=457 mm 2 x Divisorio trasversale L=151 mm 3 x Divisorio trasversale L=202 mm	23,40
FFH40100500	100/125		27,00
FFH40150500	150/175		39,30
FFH40200500	200/250		57,60

THE
BLOCK

UNIPOK
MIX AND MATCH





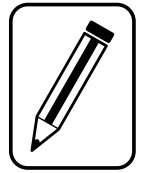

A series of horizontal lines for writing, starting from the top of the page and extending to the bottom, with a small gap at the very end.

CONDIZIONI GENERALI DI GARANZIA

Gentile Cliente,

ogni acquisto di prodotti di Fami S.r.l. è accompagnato da una garanzia convenzionale (la "Garanzia"), disciplinata in conformità alle modalità ed ai termini qui di seguito indicati.

1. PREMESSE:

Nelle Condizioni che seguono, i termini sotto indicati avranno il seguente significato:

a) Venditore: Fami S.r.l.

b) Acquirente: qualunque soggetto (persona fisica, società, ente, entità giuridica) che acquisti i Prodotti del Venditore;

c) Prodotto/i: i beni fabbricati, assemblati e/o commercializzati dal Venditore, esclusi i Prodotti a marchio Store Van;

2. OGGETTO DELLA GARANZIA

2.1 Fami S.r.l. garantisce che i Prodotti sono esenti da vizi e conformi alle specifiche tecniche dichiarate dal Venditore.

2.2 Resta inteso che le dimensioni dei Prodotti sono da intendersi tenendo conto dei margini di tolleranza d'uso nel commercio con riferimento al tipo, quantità, qualità dei Prodotti. Il Venditore, pertanto, non garantisce la rispondenza dei Prodotti a particolari specifiche o caratteristiche tecniche o la loro idoneità ad usi particolari diversi rispetto a quelle indicate nelle specifiche tecniche dichiarate da Fami S.r.l. e previste nel manuale d'uso e manutenzione, se non nella misura in cui tali caratteristiche siano state espressamente convenute nel contratto di vendita.

2.3 Qualora venga segnalata dal Cliente ed accertata la presenza di difetti sui Prodotti, il Cliente avrà diritto alla loro riparazione gratuita ovvero, qualora la riparazione risulti impossibile o economicamente onerosa, alla sostituzione gratuita del Prodotto, ad insindacabile giudizio del Venditore, con esclusione di ogni ulteriore e diversa obbligazione in capo a Fami S.r.l..

2.4 La Garanzia non pregiudica, e rimangono quindi salvi, i diritti previsti nel Decreto Legislativo 6.9.2005 n. 206 e successive modifiche ed integrazioni (il "Codice del Consumo"), nel caso in cui il Cliente sia qualificabile come "consumatore".

3. CONDIZIONI DI OPERATIVITÀ DELLA GARANZIA

3.1 Ai fini dell'attivazione della Garanzia, il Cliente avrà l'onere di informare Fami S.r.l., nei limiti temporali di cui agli articoli 4 e 5 che seguono, della scoperta di difetti tramite una segnalazione (la "Segnalazione") avente i contenuti indicati nel seguente articolo 5.

3.2 Il Cliente, fatta la Segnalazione, dovrà interrompere immediatamente l'utilizzo del/i Prodotto/i difettoso/i.

3.3 A seguito della ricezione della Segnalazione, il Venditore potrà in essere quanto necessario per accertare l'esistenza, la natura e la consistenza dei difetti e per verificare la tempestività della Segnalazione ai sensi del seguente articolo 5. A tali scopi il Cliente sarà tenuto a rendere disponibile/i il Prodotto/i difettoso/i per la loro ispezione anche tramite l'invio di documentazione fotografica ovvero l'utilizzo di sistemi di videoconferenza. Il Prodotto verrà riparato dal Venditore presso la propria sede, la propria filiale, o presso un proprio rivenditore autorizzato. Il Venditore si riserva la facoltà di riparare il Prodotto presso il Cliente. Qualora sia necessario, il Cliente dovrà provvedere ad inviare a proprie spese il Prodotto difettoso presso uno dei predetti luoghi, così come indicato dal Venditore, fatte salve le norme del Codice del Consumo. Il Venditore trasmetterà al Cliente il nuovo Prodotto o il Prodotto riparato, sostenendo i costi di spedizione.

3.4 La riparazione di un Prodotto difettoso sarà effettuata in tempi congrui rispetto all'entità del difetto.

4. DURATA – PERIODO DI COPERTURA

4.1 La durata della Garanzia per i Prodotti è di 10 anni che decorre dalla data di consegna dei Prodotti, salvo che si tratti di Prodotti commercializzati, componenti elettronici, software e le parti di usura, per i quali viene prevista una garanzia di 12 mesi che decorre, sempre, dalla data di consegna degli stessi. Si precisa che per "data di consegna" si intende la data in cui i Prodotti hanno lasciato i magazzini di Fami S.r.l. per essere consegnati al Cliente, salva diversa previsione nel contratto di vendita.

4.2 Per i Prodotti riparati o sostituiti, la garanzia decorre nuovamente ed ha una durata di 12 mesi dalla riparazione oppure dalla sostituzione. Complessivamente, pertanto, la durata della Garanzia per Prodotti riparati o sostituiti dal Venditore è di massimo 11 anni ovvero, per i Prodotti commercializzati, componenti elettronici, software e le parti di usura, di massimo 24 mesi dall'inizio della durata della Garanzia di cui al precedente articolo 4.1.

4.3 Alla scadenza del termine di cui al precedente articolo 4.1, il diritto di regresso previsto dall'art. 131 del Codice del Consumo, qualora esso sia applicabile, dovrà intendersi come prescritto ed inammissibile.

5. TEMPI E MODI DELLA SEGNALAZIONE

5.1 Durante il periodo di vigenza della Garanzia, eventuali reclami relativi allo stato dell'imballo, quantità, numero o alle caratteristiche esteriori dei Prodotti (vizi e difetti non occulti e visibili dall'esterno), dovranno essere annotati dal Cliente sulla bolla di consegna, firmando il D.D.T. indicando la dicitura "riserva specifica". Entro e non oltre 2 (due) giorni lavorativi dalla data di ricevimento dei Prodotti, il Cliente dovrà inviare al Venditore, tramite messaggio di posta elettronica al seguente indirizzo assistance@famispaspa.it, copia della bolla di consegna e relativo rilievo fotografico, fornendo informazioni dettagliate sulle condizioni dei Prodotti e sulla natura dei difetti rilevati.

5.2 Eventuali reclami relativi a difetti non individuabili mediante un diligente controllo al momento del ricevimento (vizi occulti) dovranno essere notificati al Venditore, a pena di decadenza, entro e non oltre 7 (sette) giorni dalla data della scoperta del difetto, tramite messaggio di posta elettronica certificata al seguente indirizzo pec@pec.famispaspa.it, specificando con precisione il codice prodotto, il lotto (se disponibile), la data di consegna e la natura del difetto.

6. ESCLUSIONI E LIMITAZIONE DELLA RESPONSABILITÀ

6.1 La garanzia non opera con riferimento a Prodotti i cui difetti sono dovuti a: a) operazioni di trasporto; b) mancato rispetto di accorgimenti rientranti nell'ordinaria prassi di manutenzione; negligenza e trascuratezza nell'uso; c) mancata osservanza delle istruzioni fornite dal Venditore per l'utilizzo e/o lo stoccaggio del Prodotto; d) mancato rispetto delle norme d'installazione e/o di ogni altra indicazione o istruzione riportata sulle note tecniche a corredo del Prodotto qualora l'installazione non sia stata curata direttamente dal Venditore; e) manomissioni, manutenzioni in genere, interventi operati al Cliente o da personale non autorizzato dal Venditore; f) uso anomalo e/o improprio del Prodotto, collocazione dello stesso in locali umidi, eccessivamente caldi o freddi, polverosi o aggressivi (presenza di cloro, lacche, vernici o altri agenti chimici e/o tossici) o comunque in locali non idonei alla corretta conservazione dei Prodotti nei limiti in cui tali circostanze non siano state documentate al Venditore prima dell'acquisto dei Prodotti ed il Venditore abbia garantito la tollerabilità dei Prodotti a tali ambienti; g) aggravio dei danni causato dall'utilizzo dei Prodotti da parte del Cliente una volta che si siano manifestati i difetti; h) utilizzo di parti di ricambio, componenti ed accessori non originali o non consigliati dal Venditore (non può essere richiesta la sostituzione o la riparazione di pezzi non originali) e danni provocati al Prodotto dall'uso degli stessi; i) anomalie o difettoso funzionamento dell'alimentazione elettrica; l) corrosioni, incrostazioni o rotture provocate da correnti vaganti, condense, aggressività o acidità dell'acqua, trattamenti disincrostanti effettuati impropriamente, depositi di fanghi o calcare; m) caso fortuito, cause di forza maggiore quali, a titolo esemplificativo e non esaustivo, gelo, surriscaldamento, incendio, furto, eventi naturali (come ad esempio, grandine, trombe d'aria, fulmini, inondazioni, terremoti), atti vandalici, incidenti e altri simili avvenimenti.

6.2 La Garanzia non opera se il prezzo di vendita dei Prodotti non è stato interamente saldato, con la precisazione che qualora il pagamento sia previsto in più scadenze, la Garanzia sarà da subito operativa e rimarrà tale fino a quando le scadenze di pagamento resteranno tempestivamente onorate.

6.3 Il Venditore non è responsabile per eventuali danni che possano, direttamente o indirettamente, derivare a persone, cose o animali, in conseguenza della mancata osservanza di tutte le prescrizioni indicate nel libretto di installazione, uso e manutenzione.

6.4 Il Venditore declina ogni responsabilità relativa a danni indiretti causati dalla difettosità di un Prodotto come, a titolo puramente indicativo ma non esaustivo, il fermo di produzione ovvero la mancata spedizione o cessione a terzi del Prodotto.

6.5 In ogni caso, la responsabilità del Venditore non potrà comunque eccedere il prezzo pagato dal Cliente per il singolo contratto di vendita dal cui contenuto è derivata la fattispecie inerente all'eventuale richiesta di danno e/o risarcimento.

6.6 I Prodotti dovranno essere utilizzati solo ed esclusivamente per gli scopi indicati e nel rispetto delle normative sulla sicurezza, conformemente alle previsioni del manuale di installazione, uso e manutenzione fornito dal Venditore; nel caso in cui il Cliente dovesse utilizzare o rivendere i Prodotti acquistati e/o Prodotti dal Venditore per scopi diversi, lo fa a proprio esclusivo rischio e pericolo, con ogni conseguente responsabilità. In tal caso, è esclusa la responsabilità contrattuale e/o extracontrattuale del Venditore per eventuali danni diretti ed indiretti subiti anche da terzi, nonché in caso di cattiva manutenzione, utilizzo improprio, non osservanza di norme di sicurezza ed altre ipotesi e il Cliente dovrà tenere il Venditore indenne da costi e/o responsabilità che potrebbero derivare a suo carico.

7. FORO COMPETENTE E LEGGE APPLICABILE

7.1 Per qualunque controversia derivante o connessa alle presenti Condizioni Generali di Garanzia quali, a titolo meramente esemplificativo e non esaustivo, controversie relative alla loro esistenza, validità, interpretazione, efficacia, esecuzione, è competente a decidere in via esclusiva il Tribunale di Vicenza, anche qualora il Contratto presenti elementi di internazionalità, fatte salve le norme inderogabili del Codice del Consumo.

7.2 Le presenti Condizioni Generali di Garanzia sono interamente soggetti alla legge italiana e interpretati secondo la stessa, anche qualora il Contratto presenti elementi di internazionalità, con espressa esclusione della Convenzione di Vienna del 1980.

CONDIZIONI GENERALI DI VENDITA

1. DEFINIZIONI

1.1 Nel contesto delle presenti Condizioni, i termini di seguito indicati avranno il seguente significato:

- a) Venditore: Fami S.r.l.
- b) Acquirente: qualunque società, ente, entità giuridica che acquisti i Prodotti del Venditore;
- c) Prodotti: i beni fabbricati, assemblati e/o commercializzati dal Venditore;
- d) Ordine: ciascuna proposta di acquisto dei Prodotti inoltrata dall'Acquirente al Venditore;
- e) Conferma d'Ordine: l'accettazione scritta dell'Ordine da parte del Venditore;
- f) Contratto: la vendita conclusa tra il Venditore e l'Acquirente a seguito del ricevimento da parte dell'Acquirente della Conferma d'Ordine.
- g) Parti: il Venditore e l'Acquirente congiuntamente;
- h) Marchi: tutti i marchi di cui il Venditore è proprietario o licenziatario;
- i) Diritti di Proprietà Intellettuale: tutti i diritti di proprietà intellettuale e/o industriale di Fami S.r.l., ivi inclusi, senza limitazione alcuna, i diritti relativi a: brevetti per invenzioni, disegni o modelli, modelli di utilità, Marchi, know-how, specifiche tecniche, dati, software, indipendentemente dalla registrazione o meno di tali diritti, nonché qualsivoglia domanda o registrazione relativa a tali diritti ed ad ogni altro diritto o forma di protezione di natura similare o avente effetto equivalente.

2. DISPOSIZIONI GENERALI

- 2.1 Le presenti Condizioni Generali di Vendita (di seguito, le "Condizioni") formano parte integrante dei Contratti conclusi tra il Venditore e l'Acquirente per la fornitura dei Prodotti.
- 2.2 Le Condizioni si applicano tra Fami S.r.l. (di seguito, "Fami") e l'Acquirente senza la necessità che vi sia un espresso richiamo alle stesse o uno specifico accordo in tal senso. Qualsiasi condizione o termine differente trova applicazione soltanto se confermato per iscritto da parte del Venditore.
- 2.3 Il Venditore si riserva il diritto di modificare, integrare o eliminare qualsiasi previsione delle presenti Condizioni Generali di Vendita, in qualsiasi momento, dandone notizia anche tramite la pagina a ciò dedicata del sito aziendale, restando inteso che tali aggiunte, modifiche o cancellazioni si applicheranno a tutte le Vendite concluse a partire dal 15° giorno successivo alla comunicazione (tramite pubblicazione sul sito web oppure tramite invio di newsletter o qualsivoglia corrispondenza inviata per iscritto) all'Acquirente delle nuove Condizioni di Vendita.
- 2.4 Qualsiasi riferimento a termini commerciali (come EXW, DPA, DPU, DDP, etc.) è da intendersi come richiamo agli Incoterms® della Camera di Commercio Internazionale, nel testo in vigore alla data di stipulazione del Contratto.

3. AMBITO DI APPLICAZIONE

- 3.1 Le presenti Condizioni Generali di Vendita (di seguito, le "Condizioni") si applicano a tutti i Contratti (siano essi conclusi telefonicamente, a mezzo telefax, e-mail o sito internet), ove non espressamente derogate per iscritto dalle Parti e formano parte integrante e sostanziale di ogni Ordine, Conferma d'Ordine, anche se non espressamente citate.
- 3.2 L'Acquirente non può invocare né eccepire condizioni diverse dalle presenti Condizioni. Pertanto, non hanno alcuna validità le eventuali condizioni precisate per iscritto dall'Acquirente sull'Ordine, ovvero in qualsiasi altra fase della trattativa contrattuale nonché successivamente alla Conferma d'Ordine, così come le eventuali condizioni generali di acquisto dell'Acquirente stesso. Qualsiasi condizione scritta o verbale inviata da parte di collaboratori, dipendenti, agenti o rappresentanti del Venditore è priva di valore se non riprodotta nel testo della Conferma d'Ordine o se non confermata per iscritto dal Venditore. In tal senso, l'esecuzione, anche parziale, dell'Ordine da parte di Fami od ogni altro suo adempimento nei confronti dell'Acquirente non valgono e non possono essere interpretati come tacita o implicita accettazione di qualsivoglia condizione generale di contratto che non sia stata espressamente sottoscritta da Fami.
- 3.3 Le Condizioni sono valide esclusivamente per rapporti contrattuali tra Fami e operatori professionali, per cui non troverà alcuna applicazione il D.Lgs. 6 settembre 2005, n. 206 (Codice del Consumo) e successive modifiche.

4. OFFERTE E ORDINI

- 4.1 Le offerte del Venditore non sono da considerarsi vincolanti. Le indicazioni riportate su cataloghi, prospetti e listini non impegnano il Venditore, che si riserva la facoltà di apportare qualsiasi modifica ai Prodotti ed ai relativi prezzi; pertanto, il Venditore si considera vincolato esclusivamente da quanto riportato nella Conferma d'Ordine.
- 4.2 Ciascun Ordine inviato dall'Acquirente, sia direttamente a Fami sia per il tramite degli agenti o dei rappresentanti del Venditore, è da intendersi come una proposta irrevocabile d'acquisto, destinata a rimanere efficace per 30 (trenta) giorni, decorrenti dalla data della sua regolare ricezione da parte del Venditore, salvo esplicita deroga indicata di volta in volta.
- 4.3 L'invio dell'Ordine da parte dell'Acquirente implica l'integrale presa visione e la conoscenza da parte dello stesso di tutte le presenti Condizioni, le quali dovranno quindi intendersi integralmente accettate dall'Acquirente senza limitazioni e riserve.
- 4.4 Gli Ordini e/o le eventuali modifiche degli Ordini effettuati verbalmente o telefonicamente devono essere confermati per iscritto da parte dell'Acquirente. In caso contrario, il Venditore non si assume alcuna responsabilità con riguardo ad eventuali errori o possibili fraintendimenti.
- 4.5 Il Venditore si riserva espressamente di valutare ogni Ordine, non essendo vincolato alla loro accettazione.
- 4.6 Gli Ordini regolarmente accettati dal Venditore mediante Conferma d'Ordine non potranno essere annullati dal Compratore senza il consenso scritto del Venditore.

5. CONCLUSIONE DEL CONTRATTO

- 5.1 Il Contratto potrà dirsi concluso solo a seguito dell'invio di una Conferma d'Ordine da parte di Fami (via e-mail, telefax o altri mezzi telematici equipollenti), con riferimento ad ogni singolo Ordine. In ogni caso, l'emissione della fattura da parte del Venditore oppure l'esecuzione dell'Ordine da parte del Venditore sarà considerata quale conferma.
- 5.2 Qualora la Conferma d'Ordine contenga aggiunte, limitazioni o altre variazioni rispetto all'Ordine, l'assenso dell'Acquirente a tali variazioni si intenderà tacitamente prestato salvo contestazione scritta da far pervenire per iscritto al Venditore entro 2 giorni lavorativi dal ricevimento della stessa.
- 5.3 Modifiche e integrazioni richieste dall'Acquirente successivamente alla conclusione del Contratto non avranno valore ed efficacia se non accettate per iscritto da parte del Venditore, con l'eventuale precisazione dei nuovi termini di consegna, del prezzo e delle modalità di pagamento.
- 5.4 Tutti i Contratti si intendono sempre conclusi presso la sede legale di Fami S.r.l. in Italia, 36027 Rosà (Vi), Via Stazione Rossano n. 13

6. PREZZI

- 6.1 I prezzi dei Prodotti saranno quelli indicati nel listino prezzi del Venditore in vigore al momento della conclusione dell'Ordine o, qualora il Prodotto non sia inserito nel listino prezzi o il listino prezzi non sia disponibile, quelli indicati nella Conferma d'Ordine.
- 6.2 I prezzi dei Prodotti saranno quelli indicati nella Conferma d'Ordine e, salvo patto contrario, si intendono per merce resa franco fabbrica (EXW). Tali prezzi, fatta salva diversa indicazione nella Conferma d'Ordine, non comprendono i costi e le spese di imballaggi speciali, spedizione, assicurazione e trasporto dai locali del Venditore, ogni spesa, tassa o imposta inerente alla vendita dei Prodotti, inclusi i costi di tutte le formalità doganali (a titolo esemplificativo e non esaustivo: dazi, tasse ed altri oneri per l'esportazione dei Prodotti), che restano a carico dell'Acquirente.
- 6.3 Il Venditore si riserva il diritto di effettuare un adeguamento del prezzo nel caso di modifica (a) del Contratto, richiesto dall'Acquirente successivamente alla conclusione dello stesso ed accettato dal Venditore e (b) del tipo della fornitura, del materiale o dell'esecuzione dei Prodotti dovuti all'incompletezza ovvero alla non correttezza delle informazioni e/o della documentazione fornita dall'Acquirente.

7. TERMINI DI PAGAMENTO

- 7.1 Al momento della conclusione del contratto, il Venditore potrà richiedere all'Acquirente il versamento di una caparra confirmatoria pari al 30% del valore della fornitura. Le Parti in ogni caso possono pattuire il versamento di una caparra confirmatoria diversa previo accordo per iscritto nel Contratto.
- 7.2 In caso di mancato versamento della caparra confirmatoria, ove prevista, il Contratto si intende risolto ipso iure ed il Venditore potrà richiedere il pagamento delle somme sin a quel momento maturate, oltre al risarcimento di tutti i danni patrimoniali e non patrimoniali, nonché le spese, anche legali, eventualmente sostenute.
- 7.3 Ove nel Contratto non vengano precisate le condizioni di pagamento, esso dovrà essere effettuato a 30 gg. data fattura fine mese, mediante bonifico bancario. Il pagamento si considera effettuato quando la somma entra nella disponibilità del Venditore presso la sua Banca in Italia. Ove le Parti abbiano pattuito il pagamento anticipato senza ulteriori indicazioni, si presume che il pagamento anticipato si riferisca all'intero prezzo dei Prodotti inclusi nella fornitura. In caso di consegna ripartita in più soluzioni, l'acquirente dovrà, per ognuna di esse, versare l'importo corrispondente alla merce consegnata, salvo diverso accordo scritto previsto nel Contratto.
- 7.4 I pagamenti devono essere effettuati nella valuta concordata ed eventuali spese o commissioni bancarie dovute in relazione al pagamento saranno integralmente a carico dell'Acquirente.
- 7.5 In caso di mancato o ritardato pagamento, anche parziale, da parte dell'Acquirente, il Venditore, salvi tutti gli altri suoi diritti, avrà facoltà di sospendere le ulteriori consegne anche se queste fossero dovute in dipendenza di altri contratti e richiedere l'immediato ed integrale pagamento di tutto il materiale ordinato nonché di differire le proprie consegne per un termine pari al ritardo nei pagamenti, qualunque ne sia l'importo e ciò sino al saldo di tali pagamenti e dei relativi interessi moratori.
- 7.6 Sui mancati e ritardati pagamenti il Venditore ha diritto al riconoscimento e al pagamento a suo favore degli interessi di mora ex D.Lgs. 231/2002, oltre alle spese, anche legali, che dovessero ritenersi necessarie per il recupero delle somme a qualsiasi titolo spettanti al Venditore.
- 7.7 Il mancato pagamento anche di una sola fattura comporterà per il Venditore il diritto di risolvere ogni Contratto in essere con l'Acquirente ai sensi dell'art. 1456 c.c. e di sospendere l'evasione o la consegna di ogni altra fornitura in corso di esecuzione, salvo in ogni caso il risarcimento integrale del danno conseguito dall'inadempimento o dal ritardo dell'Acquirente. Eventuali ritardi nell'evasione degli Ordini o nelle consegne causati da precedenti sospensioni della produzione per mancati pagamenti dell'Acquirente non costituiranno inadempimento del Venditore.
- 7.8 Qualsiasi reclamo o contestazione non darà diritto all'Acquirente di sospendere o ritardare i pagamenti.

8. TERMINI DI CONSEGNA

- 8.1 Il termine di consegna sarà quella indicata nella Conferma d'Ordine e, salvo patto contrario, si intende stabilita ex-works (EXW) presso lo stabilimento del Venditore. Se richiesto ed espressamente pattuito per iscritto nel Contratto, Fami si occuperà del trasporto dei Prodotti a rischio, costi e spese dell'Acquirente. Le eventuali spese di trasporto saranno a carico dell'Acquirente e ciò non inciderà in alcun modo sui rischi della spedizione che resteranno anche essi in capo all'Acquirente al più tardi con la consegna dei Prodotti al primo trasportatore.
- 8.2 La consegna dei Prodotti dovrà avvenire entro il termine indicato nel Contratto, computato in giorni lavorativi, precisato peraltro che i termini di consegna restano puramente indicativi e non sono termini essenziali e, in ogni caso, non includono i tempi di trasporto. Il Venditore, quindi, non risponderà del ritardo nella consegna per alcun motivo.
- 8.3 Qualora l'Acquirente richieda al Venditore una variazione del termine di consegna, dovrà effettuare la relativa richiesta per iscritto e procedere comunque al saldo della fornitura entro i termini indicati nell'articolo 7 delle presenti Condizioni. Restano esclusi i soli eventuali costi di custodia, consegna, montaggio, smontaggio e installazione, i quali dovranno essere saldati entro la nuova data di consegna pattuita.
- 8.4 Dal ricevimento dell'avviso di merce pronta l'Acquirente dovrà ritirare la merce nel termine massimo di 10 (dieci) giorni. In difetto, i Prodotti potranno essere stoccati all'aperto, con onere del Venditore da ogni responsabilità e decadenza, a beneficio di quest'ultima, di tutte le garanzie e con addebito all'Acquirente dei costi di movimentazione e magazzino, nonché di ogni altra eventuale spesa, sostenuti dal Venditore, che altresì si riserva la facoltà di far depositare la merce a spese dell'Acquirente.
- 8.5 Entro 10 (dieci) giorni dall'avviso di merce pronta il Venditore avrà la facoltà di emettere regolare fattura.

8.6 In caso di ritardo nel ritiro della merce, comunque approntata, per una qualsiasi ragione non dipendente dalla volontà del Venditore, la consegna si intenderà comunque come eseguita decorsi dieci giorni dalla comunicazione dell'avviso di merce pronta. In tal caso il Venditore avrà il diritto di procedere alla fatturazione e di reclamare l'adempimento delle condizioni di pagamento pattuite e potrà far effettuare l'imballaggio, il trasporto o lo stoccaggio della merce a spese dell'Acquirente, salvo il risarcimento dei danni eventualmente patiti, anche per l'immagazzinamento, la custodia ed il deposito della merce.

9. GARANZIA E RECLAMI

9.1. La regolamentazione sulla Garanzia offerta dal Venditore è contenuta nel documento Condizioni Generali di Garanzia visionabile sul sito www.famisp.com e, per quanto riguarda esclusivamente i Prodotti a marchio Store Van, nel documento Condizioni Generali di Garanzia visionabile sul sito www.storevan.com.

9.2 Al momento della presa in consegna dei Prodotti, l'Acquirente è tenuto ad esaminare i Prodotti alla presenza del trasportatore incaricato della consegna per verificare l'eventuale presenza di difetti visibili dall'esterno (a titolo esemplificativo e non esaustivo, le quantità e l'imballaggio dei Prodotti, la conformità dei Prodotti rispetto a quanto indicato nella Conferma d'Ordine).

9.3 Eventuali reclami relativi allo stato dell'imballo, quantità, numero o alle caratteristiche esteriori dei Prodotti (vizi e difetti non occulti e visibili dall'esterno), dovranno essere annotati dall'Acquirente sulla bolla di consegna, firmando il D.D.T. indicando la dicitura "riserva specifica". Entro e non oltre 2 (due) giorni lavorativi dalla data di ricevimento dei Prodotti, l'Acquirente dovrà inviare al Venditore, tramite messaggio di posta elettronica al seguente indirizzo assistance@famisp.it, copia della bolla di consegna e relativo rilievo fotografico, fornendo informazioni dettagliate sulle condizioni dei Prodotti e sulla natura dei difetti rilevati.

9.4 Fatti salvi i termini di durata della Garanzia offerta dal Venditore, eventuali reclami relativi a difetti non individuabili mediante un diligente controllo al momento della presa in consegna dei Prodotti (vizi e difetti occulti) dovranno essere notificati al Venditore, a pena di decadenza, entro e non oltre 7 (sette) giorni dalla data della scoperta del difetto, tramite messaggio di posta elettronica certificata al seguente indirizzo pec@pec.famisp.it, specificando il codice prodotto, il lotto (se disponibile), la data di consegna e la natura del difetto.

9.5 Qualsiasi Prodotto per il quale non sia stata sollevata alcuna contestazione conformemente alle procedure ed ai termini qui sopra indicati viene considerato approvato ed accettato dall'Acquirente.

9.6 In nessun caso agenti, clienti o intermediari del Venditore hanno il potere di rappresentare ed impegnare quest'ultima nei confronti dell'Acquirente o di altre terze parti. A tal fine ogni comunicazione relativa a vizi e difetti dei Prodotti sarà invalida ed inefficace qualora sia stata fatta ad agenti, clienti o intermediari del Venditore, ovvero in forme o modalità diverse da quelle sopraindicate.

10. RISERVA DI PROPRIETÀ

10.1 I Prodotti rimangono di proprietà del Venditore fino alla data in cui l'Acquirente non abbia provveduto al pagamento dell'intero prezzo degli stessi e di tutte le somme dovute al Venditore.

10.2 Nel caso in cui nel paese in cui l'Acquirente ha la propria sede, per la validità della riserva di proprietà a favore del Venditore sia necessario l'espletamento di formalità amministrative o legali quali, senza alcuna limitazione, la registrazione dei Prodotti in pubblici registri, ovvero l'apposizione sugli stessi di appositi sigilli, l'Acquirente si impegna fin d'ora a collaborare con il Venditore e a porre in essere tutti gli atti necessari al fine di far ottenere a quest'ultimo un valido diritto, anche nei confronti di eventuali soggetti terzi, con riferimento alla riserva di proprietà.

11. FORZA MAGGIORE

11.1 Sia l'Acquirente che Fami potranno sospendere l'esecuzione dei loro obblighi contrattuali quando tale esecuzione sia resa impossibile o irragionevolmente onerosa da un impedimento imprevedibile ed indipendente dalla loro volontà quale a titolo esemplificativo, non esaustivo, scioperi, epidemia e/o pandemia, boicottaggi, serrate, incendi, guerre, sommosse e rivoluzioni, requisizioni, embarghi, interruzioni di energia.

11.2 La Parte che desiderasse avvalersi della presente clausola dovrà comunicare immediatamente per iscritto, a mezzo posta elettronica certificata, all'altra il verificarsi e la cessazione delle circostanze di forza maggiore.

11.3 Qualora la sospensione dovuta a forza maggiore duri più di otto settimane, ciascuna Parte avrà il diritto di risolvere l'Ordine, previo un preavviso di 10 giorni, da comunicarsi all'altra per iscritto, mediante raccomandata con ricevuta di ritorno o mediante comunicazione a mezzo posta elettronica certificata.

11.4 In ogni caso, resta inteso che il Venditore avrà diritto di ottenere il pagamento dei Prodotti eventualmente già consegnati, oltre al rimborso di eventuali spese già sostenute.

12. MUTAMENTO NELLE CONDIZIONI PATRIMONIALI DELL'ACQUIRENTE

12.1 Fami avrà diritto a sospendere l'adempimento delle obbligazioni derivanti dalla fornitura dei Prodotti nel caso in cui le condizioni patrimoniali dell'Acquirente divenissero tali da porre in serio pericolo il conseguimento della controprestazione, salvo che sia prestata idonea garanzia. Resta inteso che il Venditore avrà diritto di ottenere il pagamento dei Prodotti eventualmente già consegnati, oltre al rimborso di eventuali spese già sostenute.

13. PROPRIETÀ INTELLETTUALI

13.1 I Diritti di Proprietà Intellettuale sono di totale ed esclusiva proprietà del Venditore e la loro comunicazione o utilizzo nell'ambito delle presenti Condizioni non crea, in relazione ad essi, alcun diritto o pretesa in capo all'Acquirente. Quest'ultimo si obbliga a non compiere alcun atto incompatibile con la titolarità dei Diritti di Proprietà Intellettuale.

13.2 L'Acquirente dichiara che: a) il Venditore è l'esclusivo titolare dei Marchi; b) si asterrà dall'utilizzare e da registrare marchi simili e/o confondibili con i Marchi; c) utilizzerà i Marchi esclusivamente in ottemperanza alle istruzioni del Venditore ed esclusivamente per i fini di cui alle presenti Condizioni.

14. FORO COMPETENTE E LEGGE APPLICABILE

14.1 Per qualunque controversia derivante o connessa alle presenti Condizioni Generali di vendita e/o al singolo Contratto quali, a titolo meramente esemplificativo e non esaustivo, controversie relative alla loro esistenza, validità, interpretazione, efficacia, esecuzione, è competente a decidere in via esclusiva il Tribunale di Vicenza, anche qualora il Contratto presenti elementi di internazionalità.

14.2 In deroga a quanto sopra stabilito, il Venditore ha comunque la facoltà di portare la controversia davanti al giudice competente presso la sede dell'Acquirente.

14.3 Le presenti Condizioni Generali di vendita e/o ogni singolo Contratto sono interamente soggetti alla legge italiana e interpretati secondo la stessa, anche qualora il Contratto presenti elementi di internazionalità, con espressa esclusione della Convenzione di Vienna del 1980.

15. PRIVACY

15.1. L'Acquirente dichiara di aver ricevuto tutte le informazioni previste ai sensi dell'art. 13 del Regolamento UE n. 2016/679 (GDPR) e presta il consenso al trattamento dei dati personali per le finalità di cui alle presenti condizioni generali di vendita e di essere stato informato che in relazione ai dati conferiti è possibile esercitare i diritti previsti dal D. Lgs. n. 196/2003 e del Regolamento UE n. 2016/679 (GDPR). Il Venditore dichiara che il titolare del trattamento dei dati raccolti è Fami S.r.l., con sede legale in Rosà (VI), Via Stazione Rossano n. 13, partita IVA e codice fiscale 03498610249

16. OSSERVANZA DELLA L. 231/2001

16.1 L'Acquirente prende atto che Fami S.r.l. ha adottato ed attua un Modello di Organizzazione, Gestione e Controllo ex D.lgs. 231/01, con i relativi Codice Etico e Sistema Disciplinare i cui dettagli possono essere visionati sul sito aziendale www.famisp.com. L'Acquirente aderisce ai principi al suddetto Modello di organizzazione, gestione e controllo nonché ai suoi allegati e si impegna a rispettarne i contenuti, i principi, e le procedure e, in generale, ad astenersi da qualsivoglia comportamento atto a configurare le ipotesi di reato indicate nel D.lgs 231/01 e sue successive modifiche ed integrazioni e riportate nel predetto Modello di organizzazione, gestione e controllo. L'Acquirente si impegna inoltre a rispettare e a far rispettare ad eventuali suoi collaboratori, tutti i principi contenuti nella suddetta documentazione ed i Protocolli comportamentali previsti dalla nostra organizzazione ai sensi del D. Lgs. 231/2001 ed allegati al presente contratto. La violazione delle regole previste dai sopracitati documenti rappresenterà grave inadempimento contrattuale.

17. DISPOSIZIONI FINALI

17.1 Qualora una delle Parti ometta di intraprendere un'azione giudiziale o di esercitare un diritto in base alle presenti Condizioni, tale comportamento di acquiescenza non potrà essere interpretato come una definitiva rinuncia ad esercitare in futuro la stessa azione giudiziale o lo stesso diritto.

17.2 La vendita dei Prodotti da parte di Fami all'Acquirente non fa sorgere a favore di quest'ultimo un diritto di esclusiva territoriale né consente all'Acquirente di assumere la qualità di distributore o concessionario di Fami.

17.3 L'invalidità in tutto o in parte di singole disposizioni delle presenti Condizioni non inficia la validità delle restanti previsioni.

BREVETTI

Alcuni componenti sono protetti da modello di design comunitario e/o brevetto di invenzione industriale.

AIR



WWW.FAMISPA.COM

VIA STAZIONE ROSSANO 13
36027 ROSÀ (VICENZA) ITALIA

TEL. +39 0424 58 54 55
FAX +39 0424 58 54 70

E-MAIL: INFO@FAMISPA.IT

TIMBRO RIVENDITORE



PELIZZARI
FAUSTINO
UTENSILI