

PELIZZARI
FAUSTINO
UTENSILI SRL



*Single, Double
or Self-centering!*

FMS

Morse e Cubi / Vises & Vise Towers

INDICE - INDEX

pages		pages		pages		pages		pages	
Art.	5.	Art.	5.	Art.	5.	Art.	5.	Art.	5.
62	50	805N	54 - 55	810XA	27	860D	14		
62K	67 - 69	805O	54 - 55	810Y	27	860E	14		
81P	50	805P	55	810YA	27	860F	14		
84U	31	805Q	55	810Z	27	863	16		
90	35	805R	55	812	31	863C	46		
99A	67 - 69	805T	55	812A	31	863D	16		
99B	67 - 69	805U	31	812B	31	863E	16		
99H	67 - 69	805UA	31	812C	31	863F	16		
99S	67 - 69	805V	35	813	31	864	18		
220 G01	58	805VA	35	813A	31	865	20		
220 G02	58	806	22	813C	31	865D	20		
220 G11	58	806A	22	814	56	865E	20		
266B	62 - 63 - 64	806B	23	815	31	865F	20		
247T	35	806C	23	815A	31	866	24		
375	61	806D	23	815C	31	866D	24		
512	57	806E	23	818	52	866E	24		
296	6	806F	22	821	53	866F	24		
547G	58	806G	23	822	53	867	28		
547K	58	806H	23	823	59	867D	28		
566	62	806M	23	823B	59	867E	28		
571	62	806K	23	825	59	867F	28		
800	38	806SLD	23	825A	61	868	32		
800A	38	806SLE	23	825B	59	868D	32		
800B	38	807	22	825C	59	868E	32		
800C	42-43	807A	22	827A	60	868F	32		
800D	38	808	22	828A	60	870	36		
800E	61	808A	22	829A	52	870A	54		
800G	42-43	808B	22	830	52	870C	46		
800I	61	810	56	831	59	870D	36		
801	50	810A	56	832	59	870E	36		
801G	61	810B	56	833	59	870F	36		
801H	61	810D	56	834	59	882A	38		
801I	61	810DT	57	835	60	890	62 - 65		
801S	61	810E	57	836	60	890K/1	62		
802	72	810J	56 - 57	837	60	890K/2	63		
804	49	810K	57	838	60	890K/3	63		
805	54	810L	57	850B	61	890K/4	64		
805A	54	810M	57	850C	61	891	62		
805B	54	810O	56 - 57	850E	61	892	62		
805C	54	810P	57	850H	61	900	40		
805D	55	810Q	31	850P	72	900Y	40		
805DT	55	810QA	31	850T	61	983	3		
805E	55	810R	57	852	60	DPG250	66		
805F	54 - 55	810T	57	853	60	DIVIGER 205	68		
805G	55	810U	31	855	12				
805H	55	810UA	31	855C	44 - 45 - 48				
805I	55	810UZ	31	855D	12				
805J	55	810V	57	855E	12				
805K	55	810W	27	855F	12				
805L	55	810WA	27	860	14				
805M	55	810X	27	860C	44 - 45				

VALIGETTA DI CAMPIONATURA FMS (Art.860)

FMS SAMPLE KIT CASE (Art.860)

NEW

 Valigetta di campionatura morsa Art.860 T.1x300
 Sample kit case Art.860 T.1x300 vise

Cod. 0.98.30000

PRICE LIST €

SPECIAL PRICE €

All'Interno - Inside:

Art.810L	Art. 806B	Art.297 16/18
Art. 807	Art. 806C	Art.850H
Art. 810X	Art.806D	Art.370 T1 Std
Art. 814	Art.806E	Art.375 CH12
Art. 810J	Art.806F	- -
Art. 814	Art.298	- -



SIMBOLOGIA DATI TECNICI

TECHNICAL DATA ICONS

GANASCE JAWS		Piane Straights		A gradino With step		Oscillanti Floating		Oscillanti con inserti regolabili Floating with inserts adjustable		Prismatiche Prismatic
	PIASTRE GANASCE JAW PLATES		Discendente Pull down		Piana Straight		Cambio rapido manuale Quick manual change		GRIP GRIP	
POSSIBILITÀ POSSIBILITY			Predisposizione Zero Point Zero Point Ready		Cubi-morsa Vise tower		Divisore Automatico Automatic dividing head		Divisore Meccanico Mechanical dividing head	
	PAGINE PAGES		Lavorazioni a 5 assi 5 axis machining		Accessori & Ricambi Accessories & Spare Parts		Istruzioni corretto utilizzo Instruction for a proper use		Diagrammi forze di serraggio Clamping force diagrams	

Morse e cubi morsa / Vises & vise-towers

FMS SERIES

 Precisione / Accuracy
 $\pm 0,02\text{mm}$

 Durezza / Hardened
HRC 58 \pm 2
Un sistema modulare flessibile con centinaia di ganasce disponibili
A Flexible modular system with hundreds of jaws available

ESTREMA VERSATILITÀ / EXTREME VERSATILITY

- 3 posizioni per la ganasca fissa; • Serraggio dall'esterno all'interno e viceversa;
- Posizionamento verticale-orizzontale-laterale; • Collegamento: fianco a fianco, dorso a dorso, fianco a dorso; • Possibilità illimitata per ganasce speciali; • Sostituzione semplice e precisa delle ganasce;
- Elemento di prolunga per pezzi fuori misura; • Sistema di serraggio meccanico, idraulico, pneumatico elettrico o con moltiplicatore di potenza, tramite comando manuale, a pedale o mediante pulsante elettrico (vedi pag. 12); • Costruzione solida e compatta e massima apertura rispetto alla sua lunghezza;
- Flessioni praticamente ridotte di due volte rispetto alle precedenti morse modulari standard; • Accurata ripetibilità di posizionamento del pezzo da lavorare; • Precisioni geometriche con tolleranze entro 0,02 mm; • Protezione integrale dalla penetrazione di corpi estranei tramite piastre scorrevoli; • Possibilità di trasformazione di ogni morsa singola in morsa autocentrante o in morsa doppia tramite la semplice sostituzione delle ganasce sul corpo base universale. (ESEMPI APPLICATIVI A PAGINA 5.76).

- 3 positions for the fixed jaw; • Outside to inside clamping and viceversa; • Vertically, horizontally and sideways vise positioning; • Side to side, back to back and back to side vise positioning; • Unlimited special jaws; • Simple and precise exchange of jaws; • Extension element for extra-long pieces; • Mechanic, hydraulic or pneumatic or electrical clamping system or with pressure multiplier, through manual, pedal or push button control (see page 12); • Space saving design, solid construction and maximum blocking ratio to total length; • Deflection reduced two times with respect to the STANDARD modular vises; • Very accurate repeatability of workpiece position; • Geometrical accuracy with tolerances within 0,02 mm; • Integral protection from chips and dirty through sliding protection; • Possibility to transform each single vise in a self-centering vise with possibility to block from outside to inside and vice versa and in a double vise through the simple substitution of the jaws on the universal vise body base.

(APPLICATION EXAMPLES ON PAGE 5.76)

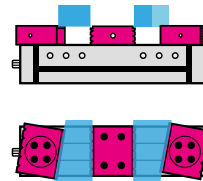
Ganasce Mobili Oscillanti

per serraggio di pezzi irregolari

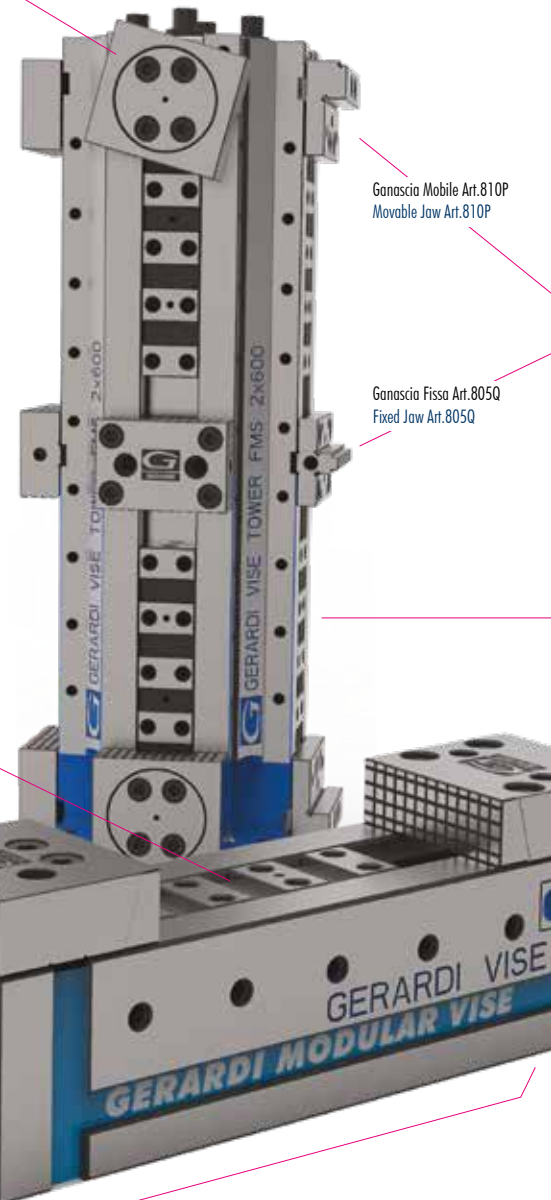
Floating Movable Jaws
 for irregular workpieces

 Ganasca Mobile Art.810P
 Movable Jaw Art.810P

 Ganasca Fissa Art.805Q
 Fixed Jaw Art.805Q

Vite a doppio filetto e slitte guidate
Double thread spindle & guided slides

Vite principale (completamente protetta) con filetto destro e sinistro e slitte lunghe quanto il corpo base e guida con più chiavette per ganasce mobili

Completely protected main spindle with left and right thread and slides long as the vise base with multiple movable jaw positions



Chiavette di Posizionamento
Positioning Keyways

Chiavette longitudinali e trasversali sia sulla base per posizionamento orizzontale, che in testa per posizionamento verticale

Longitudinal and cross keyways both on the base bottom surface for horizontal positioning and on the side for vertical positioning

Nata espressamente per i centri di lavoro, la gamma FMS permette ottimizzazioni di serraggio con riferimenti precisi in spazi contenuti, usure inesistenti e rigidità impensabile (spessore della base raddoppiato), possibilità di bloccare più pezzi contemporaneamente con l'ausilio di sistemi meccanici, pneumatici, elettrici o idraulici. Tutte sono disponibili/predisposte sia per piazzamenti verticali che orizzontali. Serraggi di qualsiasi lunghezza. La caratteristica (Brevettata) che meglio contraddistingue questa serie di morse consiste nella possibilità di trasformare ogni morsa singola (cioè adibita al serraggio di un singolo pezzo) in una morsa auto-centrante con bloccaggio concentrico dall'esterno all'interno e viceversa e in morsa doppia tramite la semplice sostituzione delle ganasce sul corpo base universale. Tutto ciò ne suggerisce l'impiego in situazioni produttive caratterizzate da lotti di pezzi estremamente diversi fra loro riducendo tempi di set-up e garantendo un'accurata ripetibilità di posizionamento e quindi di precisione migliorando l'efficienza globale del sistema produttivo.

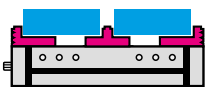
Born to be dedicated to machining centres, FMS series of vises allow workholdings with perfect alignment in a space saving design, extremely high wear resistance, with deflection reduced 2 times in respect to the STD modular vises (base thickness doubled), possibility to clamp more pieces simultaneously with mechanic, hydraulic pneumatic or electric devices. You can use them both for vertical and horizontal clamping without any price charge. Grip any work length. The feature (Patented) which identifies this line of vises consists in the possibility to transform each single vise (1 piece clamping) in a self-centering vise with possibility to block from outside to inside and viceversa and in a double vise through the simple substitution of the jaws on the universal vise body base. All that suggests their use in the production of lots of highly different pieces reducing set-up times and assuring very accurate repeatability of workpiece position and precision, increasing the global efficiency of the production process.



Serraggio particolare su gradino grande
Workpiece clamping on the large step

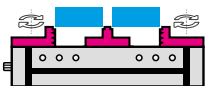

Serraggio particolare su gradino piccolo
Workpiece clamping on the small step

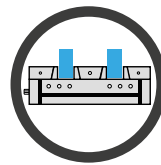

Singole, Doppie o Autocentranti!
Single, Double or Self-centering!



3 Morse in Una 3 Vises in One

Possibilità di trasformare ogni morsa singola in una morsa auto-centrante con bloccaggio concentrico dall'esterno all'interno e viceversa e in morsa doppia tramite la semplice sostituzione delle ganasce sul corpo base universale.

Possibility to transform each single vise in a self-centering vise with possibility to block from outside to inside and viceversa and in a double vise through the simple substitution of the jaws on the universal vise body base



Altissima Rigidità Highest Rigidity

Base della morsa con una sezione doppia per garantire una maggiore rigidità. Flessioni ridotte di due volte rispetto alle normali morse modulari standard. Disponibili cubi monoblocco.

Higher vise base in order to guarantee a better rigidity. Bending reduced two times with respect to the Standard modular vises. Available solid vise towers.

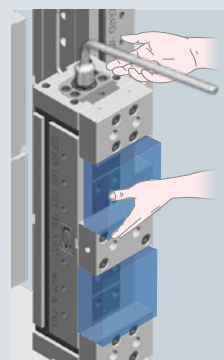

Sistema a terza mano Third Hand service

Consente il carico e serraggio lieve del primo pezzo mentre le frattempo viene caricato il secondo di dimensione maggiore. Molto utile con l'utilizzo verticale della morsa

It allows the first workpiece loaded to be clamped lightly while the second workpiece is being loaded. Such device is useful especially with the vise vertically positioned.



Riconfigurazione Rapidissima Quickest Vise Resetting

Ganasce con piastre discendenti a cambio rapido manuale
Pull down jaw plates with comb system (quick hand change)

Staffe di ancoraggio / Vise holding clamps



FMS

Coppia staffe di fissaggio Art.296, complete di vite e dado a "T"

Pair of vise holding clamps Art.296 complete of screw and "T" nuts



Esempio d'ordine per morsa tipo 3 su macchina con cave a T da 18mm: Art.296 T.3 X=18mm

Oppure con codice: 2.29.6300 X=18mm

Order example for Type 3 vise on machine with 18mm T-slots: Art.296 T.3 X=18mm

Also with code: 2.29.6300 X=18mm

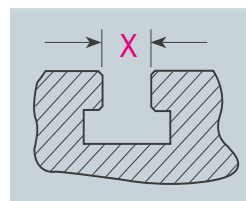
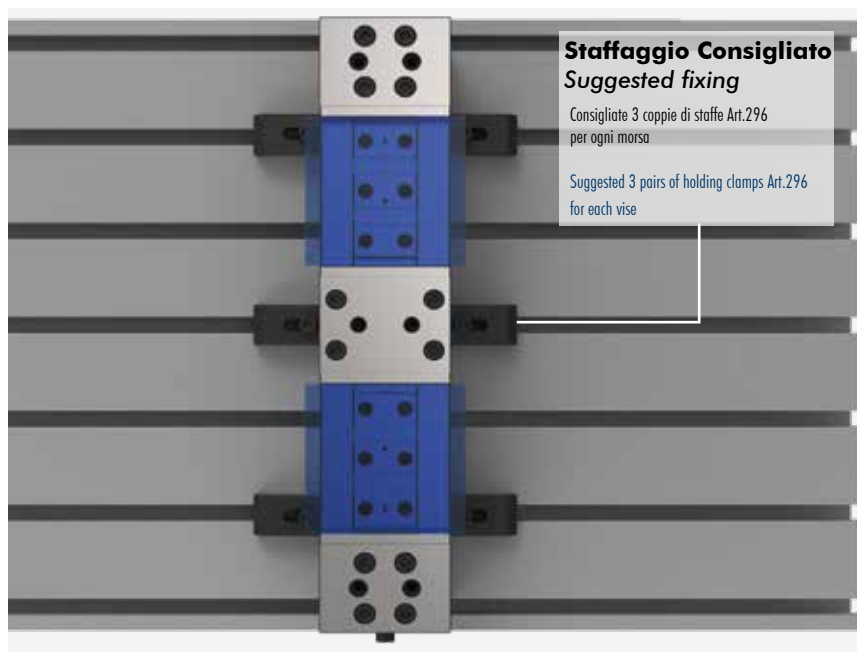

Cava a T

T Slot

Specificare sempre la cava della vostra macchina

Always specify the machine T-slot dimension

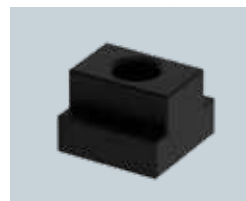

Art.287 (Pag.4.34)

Dadi a T - T Nuts

Per fissaggio morse alle cave a T della macchina

For vise clamping on the machine T-slots

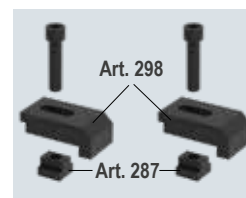

Art.296

(Art.298 + Art.287)

Consigliate 3 coppie di staffe Art.296 per ogni morsa

Suggested 3 pairs of holding clamps Art.296 for each vise

Tipo (grandezza) Type (size)	1				1				2 - 3				4 - 5 - 6															
Art. 296	Cava a T slot X	12	14	16	18	12*	14	16	18	18*	20	22	16	18	20	22	18*	20	22	16	18	20	22					
	T-nuts Ref. N°	8	9	10	11	12	13	14	20	21	22	32	39	40	20	21	22	23	32	39	40	20	21	22	23	32	39	40
Coppia di staffe Holding clamps pair	Filetto vite Screw thread	M8				M10				M12 *				M16														
1 X M8 	A	50	50	50	50	76	76	86	86																			
	B	24	24	24	24	30	30	40	40																			
	C	6	6	6	6	6	6	10	10																			
	ØD	8,5	11	13	17	13	17	13	17																			
	E	10	10	10	10	13	13	15	15																			
	ØF	14	-	-	-	-	-	-	-																			
	G / G1	14	16/15	17,5/13	19/9	17/22	16/15	26/27	26/27																			
	H	34	34	34	34	42	42	50	50																			
	I	8	10	10	10	-	-	-	-																			
	J	4	4	4	4	10	10	10	10																			
T ± 0,1	15	15	15	15	20	20	26	26																				
Cod.	2.29.61000 / M8	2.29.61000 / M10	2.29.61000 / M12	2.29.61000 / M16	2.29.63000 / M12	2.29.63000 / M12	2.29.65000 / M12	2.29.65000 / M16																				

* Scelta consigliata - Suggested choice

* Scelta NON consigliata - NO Suggested choice

Soluzioni personalizzate / Customized solutions

FMS

Soluzioni personalizzate a tutti i vostri problemi di serraggio

Customized solutions for all your clamping problems

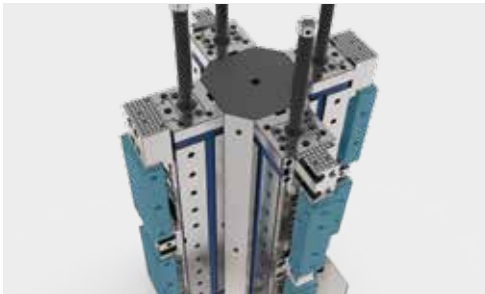

Morse FMS automatizzate in verticale

FMS vises automated vertically mounted

Gestione automatica di morse meccaniche grazie alla predisposizione per connessione con il robot. Lavorazioni del particolare su 3 lati con un unico serraggio evitando il riposizionamento ed una seconda ripresa del particolare da lavorare.

Automated machine setting thanks to the pre-fitting with robot connection. Workpiece machining on 3 sides with one clamping and so avoiding re-positioning and a second machining of the workpiece.

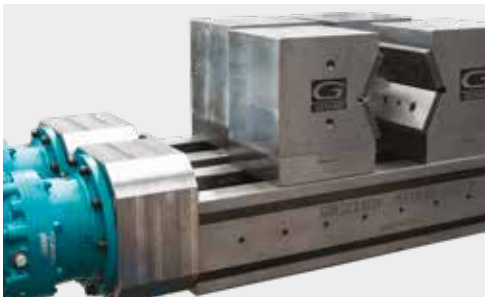

Morsa FMS con riduttore epicicloidale

FMS vise with epicyclic force reducer

Riduttore epicicloidale il quale consente di moltiplicare notevolmente la coppia sviluppata dal motore idraulico consentendo di arrivare a elevate forze di serraggio, fino a 480 kN

Epicyclic force reducer able to multiply greatly the torque generated by the hydraulic engine reaching a very high clamping force, maximum 480kN.

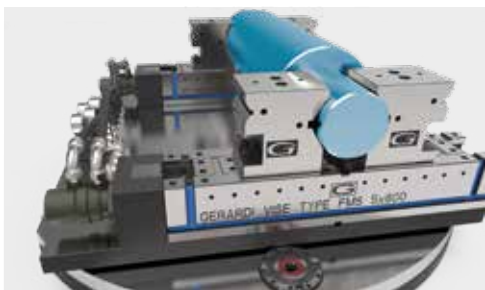

Serraggio automatico di grandi particolari tondi

Round workpieces automatic clamping

Sistema di serraggio meccanico con morse FMS per il serraggio di particolari tondi di grandi dimensioni controllato tramite centralina idraulica da CNC

Quick positioning and clamping with FMS vises of whole equipment on round Zero Point plate through pull-studs and centering pin.



Non solo per centri a 5 assi

Not only for 5th axis machines

Morsa autocentrante FMS su centro di lavoro verticale con ganasce personalizzate in alluminio.

Self Centering FMS vise with taylor made jaws aluminum mounted on Vertical CNC



Morse FMS in verticale con robot

FMS vises vertically mounted + robot

Assieme di morse FMS montate verticalmente su centro orizzontale gestite tramite robot anche per carico e scarico pezzi

FMS vises vertically mounted on horizontal machining center.

Both vise clamping and workpieces turnover are operated through automated robotic system.

TRE MORSE IN UNA THREE VISES IN ONE



Acquista il modulo base universale. Una soluzione aperta per il lavoro di oggi pensando a quello di domani !
Buy the base body. A Versatile solution for present and future machining !

CORPO BASE Art.855

BASE BODY Art.855

Modulo base universale
CENTINAIA DI GANASCE DISPONIBILI !!

Universal vise body module
HUNDREDS OF JAWS AVAILABLE !!

SERRAGGI SINGOLI

SINGLE CLAMPING

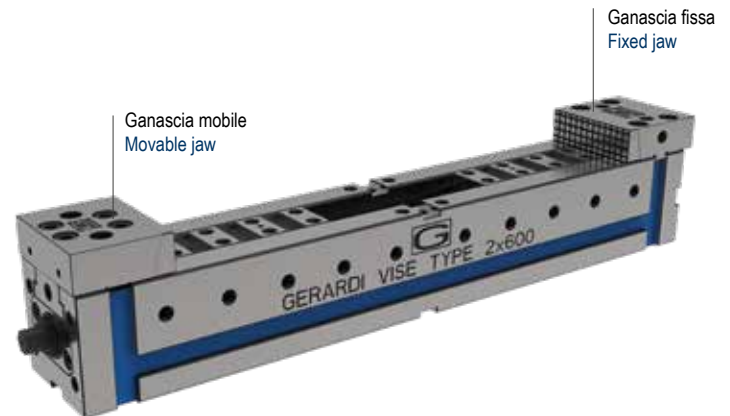
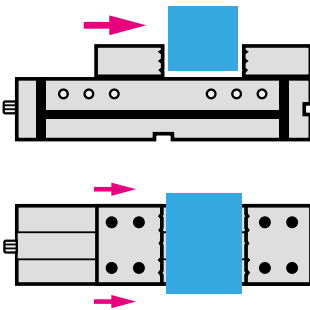

SERRAGGI DOPPI

DOUBLE CLAMPING

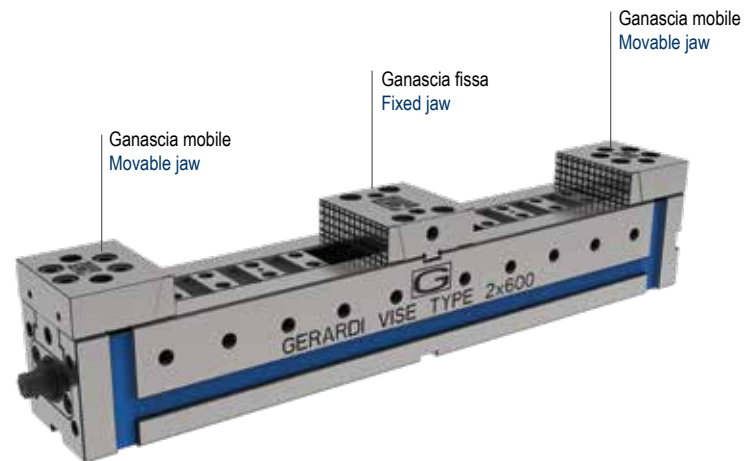
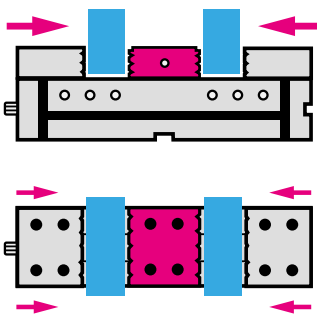

AUTOCENTRANTE

SELF-CENTERING

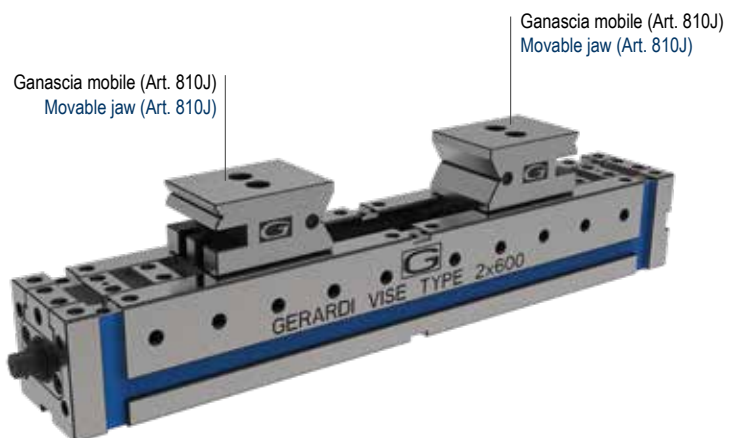
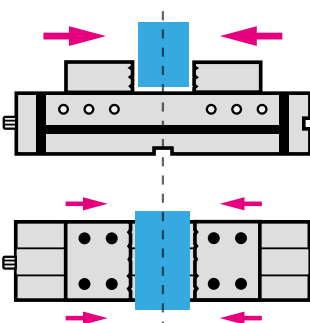

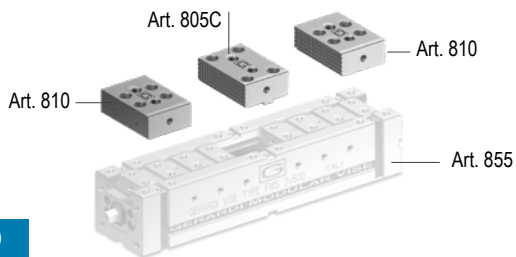
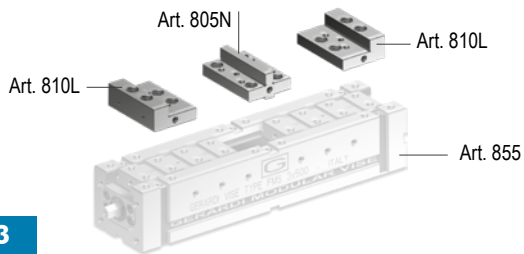
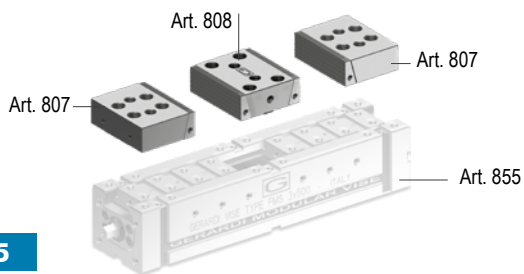
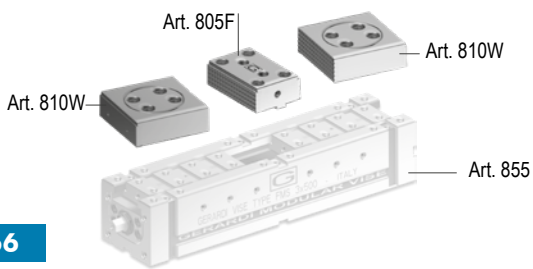
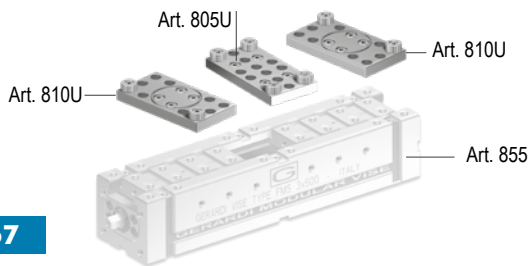
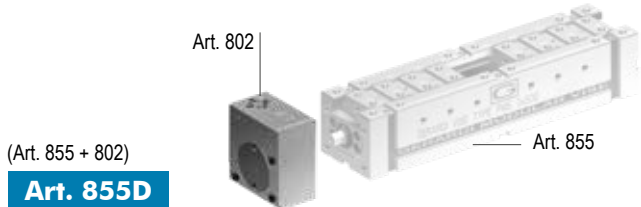
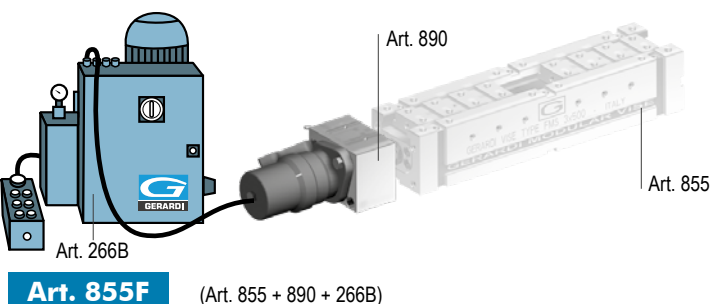
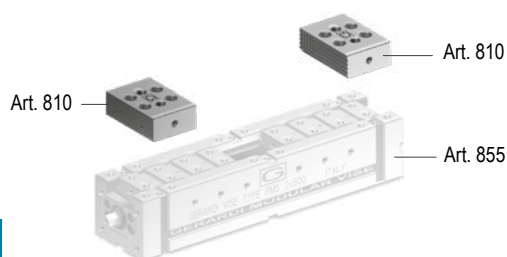
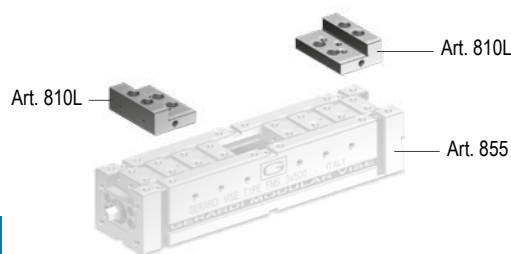
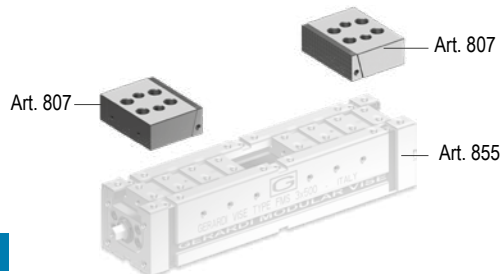
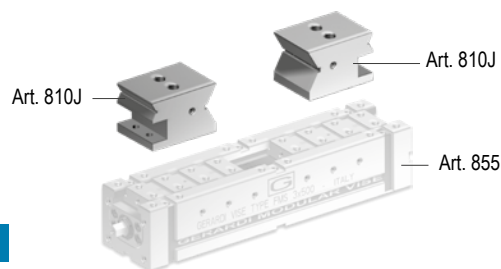
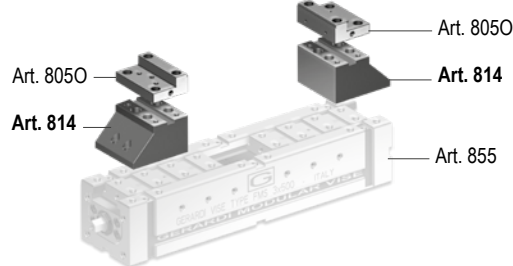
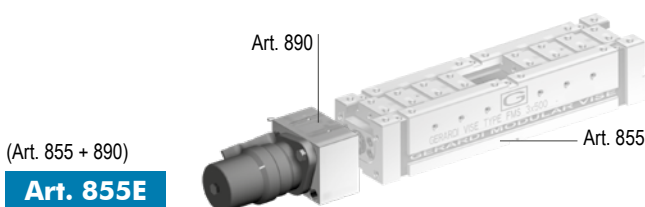
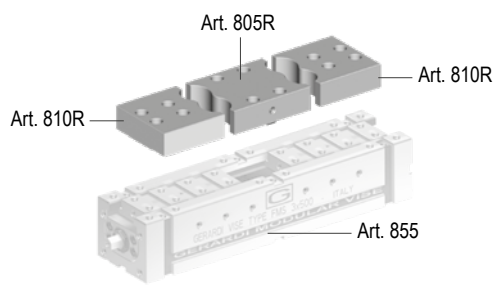
VERSIONI PER BLOCCAGGI DOPPI
DOUBLE CLAMPING CONFIGURATION

Art. 860

Art. 863

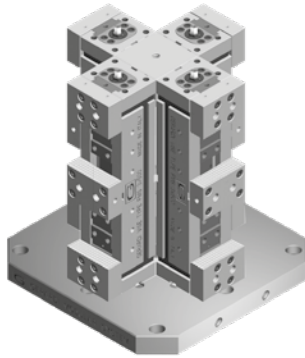
Art. 865

Art. 866

Art. 867

Art. 855D

Art. 855F
VERSIONI AUTOCENTRANTI
SELF-CENTERING TYPE

Art. 860

Art. 863

Art. 865

Art. 870

Art. 868

Art. 855E

CUBI DI MORSE MONTATI A CROCE O DORSO A DORSO

VICE TOWERS CROSS OR BACK TO BACK MOUNTED



N° 4 MORSE FMS

montate a croce su piastra base (Art. 827A)
 con distanziali (Art. 835)

N° 4 FMS VISES

cross-mounted on base plate (Art. 827A)
 with spacers (Art. 835)

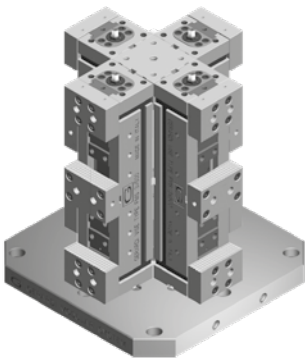

N° 4 MORSE FMS

montate a croce su piastra base (Art. 827A)
 con supporto centrale (Art.836)

N° 4 FMS VISES

cross-mounted on base plate (Art.827A)
 with center support (Art.836)

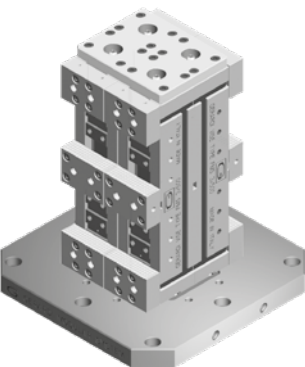

N° 4 MORSE FMS

montate dorso a dorso, fianco a fianco, su piastra base
 (Art. 827) con piastra di collegamento (Art. 832)

N° 4 FMS VISES

cross-mounted back-to-back, side by side, on base
 plate (Art. 827) with connecting plate (Art. 832)

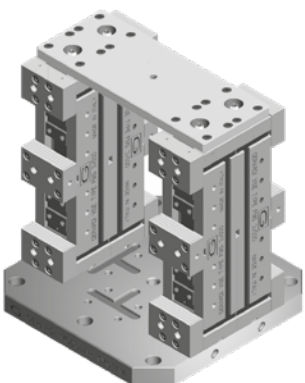

N° 4 MORSE FMS

montate dorso a dorso, su piastra base
 (Art. 827A) con piastra di collegamento (Art. 832)

N° 4 FMS VISES

cross-mounted back-to-back, on base plate
 (Art. 827A) with connecting plate (Art. 832)

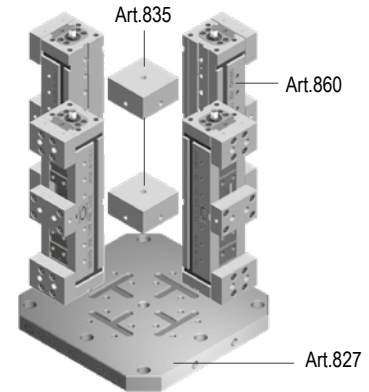

**MECCANISMO
 TERZA MANO
 INCLUSO
 THIRD HAND
 DEVICE
 INCLUDED**

Art.850P

(Pag - Page 5.71)

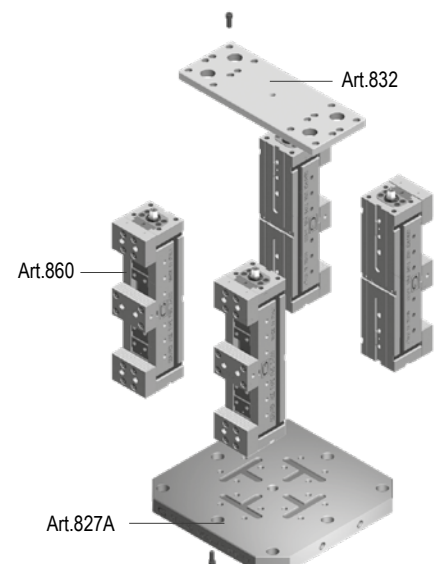
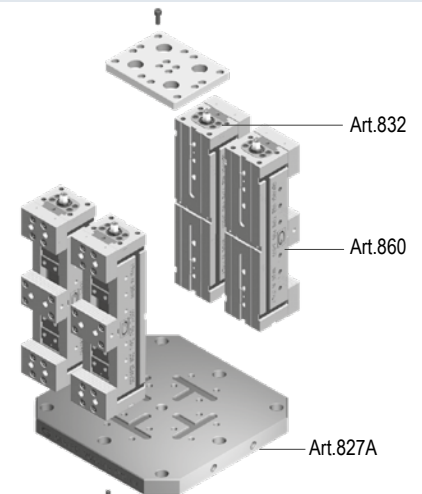
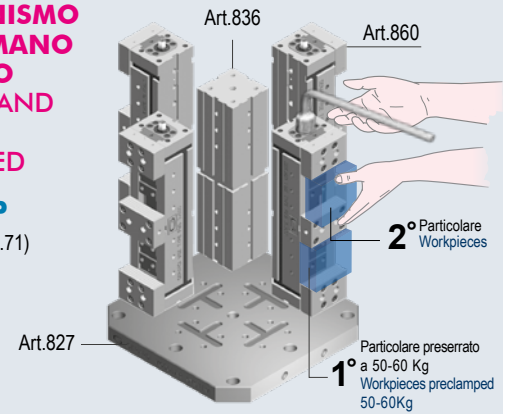

Montaggio ed allineamento morsa con distanziali, supporto centrale o piastra di collegamento
 Vise and alignment mounted with spacers, center support or connecting plate

CUBI DI MORSE MONTATI VERTICALMENTE

VISE TOWERS VERTICALLY ASSEMBLED

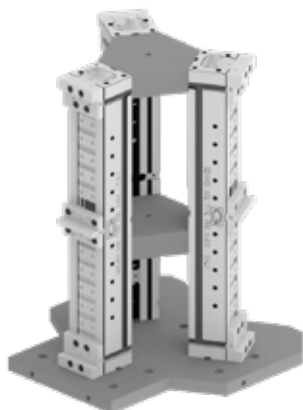

N° 3 morse FMS

montate verticalmente su piastra base a Y (827A)
 con supporto centrale (Art. 838)

N° 3 FMS vises

vises vertically mounted on Y base plate (827A)
 with exagon center support (Art. 838)

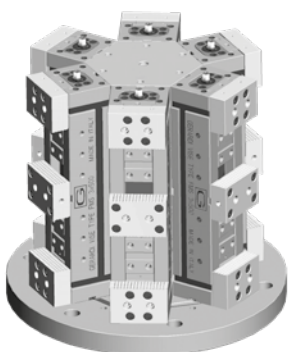
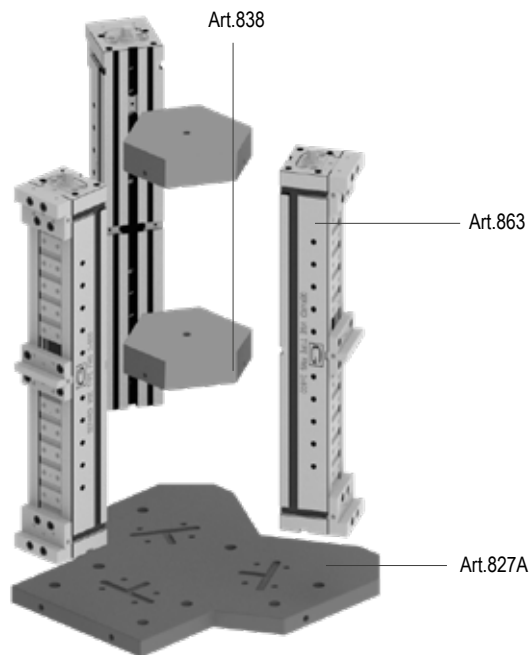

N° 6 morse FMS

montate verticalmente su piastra base (Art. 827A)
 con distanziali esagonali (Art. 838)

N° 6 FMS vises

vises vertically mounted on base plate (Art. 827A)
 with exagon spacer (Art. 838)

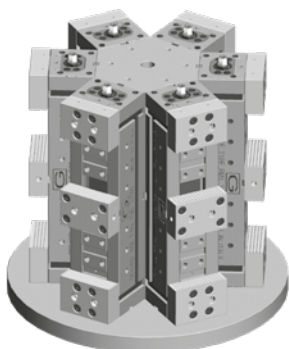
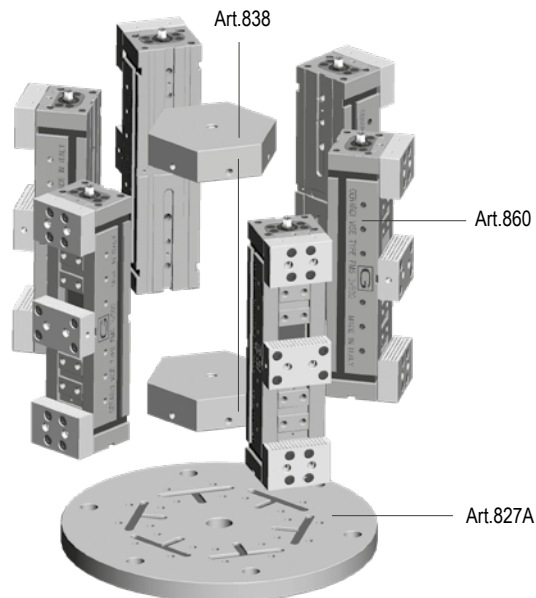

N° 6 morse FMS montate verticalmente
 su piastra base (Art. 827A)
 con supporto centrale (Art. 837)

N° 6 FMS vises vertically mounted
 on base plate (Art. 827A) with exagon
 center support (Art. 837)

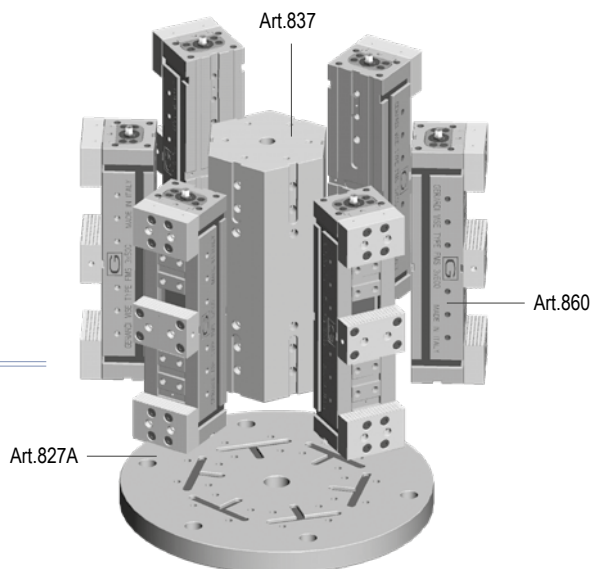

Montaggio ed allineamento morse con distanziali, supporto centrale o piastra di collegamento
 Vise and alignment mounted with spacers, center support or connecting plate

Tipo (grandezza) morsa / Vise type (size)	kN	1		2			3		
		25 kN		25 kN			30 kN		
Apertura massima fra le slitte / Maximum opening between slides	A	56	68	96	116	136	156	136	136
	C	70		90			100		
	D	200 + 32	300 + 32	300	400	500	600	400	500
	E	249	349	320	420	520	620	425	525
	G	75		95			125		
	R	74		94			124		
	S	69		89			99		
	T	72	116	102	142	182	222	132	182
	Y	277	377	360	460	560	660	470	570
	X	389	483	537	637	737	837	637	737
	kg	7	10	18	25	32	39	40	45
	Cod.	5.85.51200	5.85.51300	5.85.52300	5.85.52400	5.85.52500	5.85.52600	5.85.53400	5.85.53500

Art. 855

Modulo base universale
CENTINAIA DI GANASCE DISPONIBILI !!



Universal vise body module
HUNDREDS OF JAWS AVAILABLE !!

Art. 855D

Art. 802

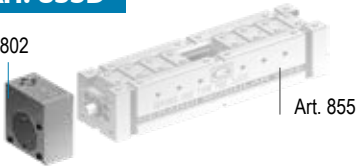

(Art. 855 + 802) Morsa + moltiplicatore di coppia / Vise + torque multiplier

Cod.	5.85.5D120	5.85.5D130	5.85.5D230	5.85.5D240	5.85.5D250	5.85.5D260	5.85.5D340	5.85.5D350
------	------------	------------	------------	------------	------------	------------	------------	------------

Moltiplicatore di coppia con rinvio angolare - Mechanical with torque multiplier with angular transmission

Chiave dinamometrica Art.357 (Inclusa) - Torque wrench Art.357 (Included)

Cod.	5.80.21000	5.80.22000	5.80.23000
------	------------	------------	------------

Art. 802



Art. 855E

Art. 890

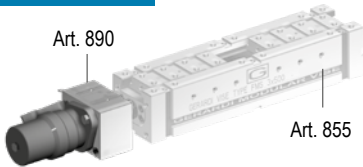

(Art. 855 + 890) Morsa + motore idraulico / Vise + hydraulic motor

Cod.	5.85.5E120	5.85.5E130	5.85.5E230	5.85.5E240	5.85.5E250	5.85.5E260	5.85.5E340	5.85.5E350
------	------------	------------	------------	------------	------------	------------	------------	------------

Meccanica con predisposizione elettroidraulica completa di motore, piastra, boccola e finecorsa

Art. 855F

Art. 266B

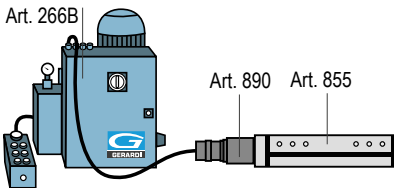

(Art. 855 + 890 + 266B) Morsa + motore idraulico + centralina / Vise + hydraulic motor + power unit

Cod.	5.85.5F120	5.85.5F130	5.85.5F230	5.85.5F240	5.85.5F250	5.85.5F260	5.85.5F340	5.85.5F350
------	------------	------------	------------	------------	------------	------------	------------	------------

Meccanica elettroidraulica completa di centralina idraulica apparecchiatura elettrica con pulsantiera

Dotazione standard:

- 2 arresti laterali Art. 370
- 1 coppia di tasselli di posizionamento per cava da 16 mm Art. 297
- 1 chiave a pipa Art. 375
- 1 piastrina di collegamento Art.801S

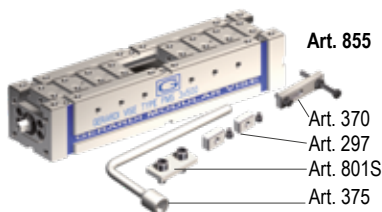

Standard equipment:

- 2 workstops Art. 370
- 1 pair of positioning key-nuts for 16 mm slot Art. 297
- 1 box wrench Art. 375
- 1 connecting plate Art.801S

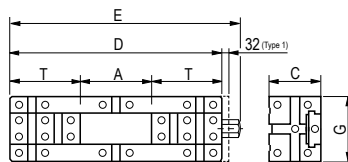

Art. 855

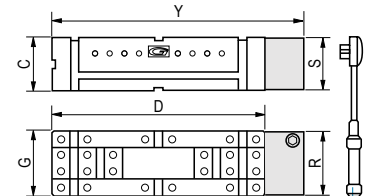

Art. 855D

Art.357 (Incluso)
 Art.357 (Included)

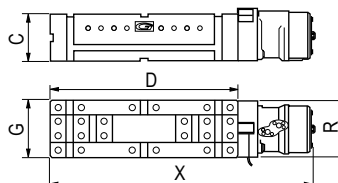

Art. 855E

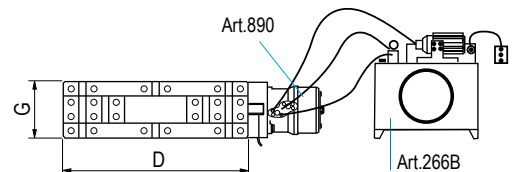

Art. 855F

	3 30 kN			4 30 kN				5 32 kN			6 32 kN		
A	136	136	136	188	168	148	128	152	216	252	316	280	244
C		100			120				140			160	
D	600	700	800	500	600	700	800	600	700	800	800	900	1000
E	625	725	825	525	625	725	825	625	725	825	825	925	1025
G		125			145				170			190	
R		124			144				169			189	
S		99			119				139			159	
T	232	282	332	156	216	276	336	174	242	274	242	310	378
Y	670	770	870	570	670	770	870	-	-	-	-	-	-
X	837	937	1037	737	837	937	1037	837	937	1037	1037	1137	1237
kg	50	55	60	66	72	80	88	115	125	135	170	190	210

Cod. 5.85.53600 5.85.53700 5.85.53800 5.85.54500 5.85.54600 5.85.54700 5.85.54800 5.85.55600 5.85.55700 5.85.55800 5.85.56800 5.85.56900 5.85.56100

Art. 855D

(Art. 855 + 802) Morsa + moltiplicatore di coppia / Vise + torque multiplier

Cod. 5.85.5D360 5.85.5D370 5.85.5D380 5.85.5D450 5.85.5D460 5.85.5D470 5.85.5D480 5.85.5D560 5.85.5D570 5.85.5D580 5.85.5D680 5.85.5D690 5.85.5D610

Art. 802

Moltiplicatore di coppia con rinvio angolare - Mechanical with torque multiplier with angular transmission

Cod. 5.80.23000 5.80.24000 5.80.25000 5.80.26000

Art. 855E

(Art. 855 + 890) Morsa + motore idraulico / Vise + hydraulic motor

Cod. 5.85.5E360 5.85.5E370 5.85.5E380 5.85.5E450 5.85.5E460 5.85.5E470 5.85.5E480 5.85.5E560 5.85.5E570 5.85.5E580 5.85.5E680 5.85.5E690 5.85.5E610

Mechanical with prepared hydraulic connection complete with motor plate, bushing and proximity switch

Art. 855F

(Art. 855 + 890 + 266B) Morsa + motore idraulico + centralina / Vise + hydraulic motor + power unit

Cod. 5.85.5F360 5.85.5F370 5.85.5F380 5.85.5F450 5.85.5F460 5.85.5F470 5.85.5F480 5.85.5F560 5.85.5F570 5.85.5F580 5.85.5F680 5.85.5F690 5.85.5F610

Mechanical with elettrohydraulic power-pack ready to work

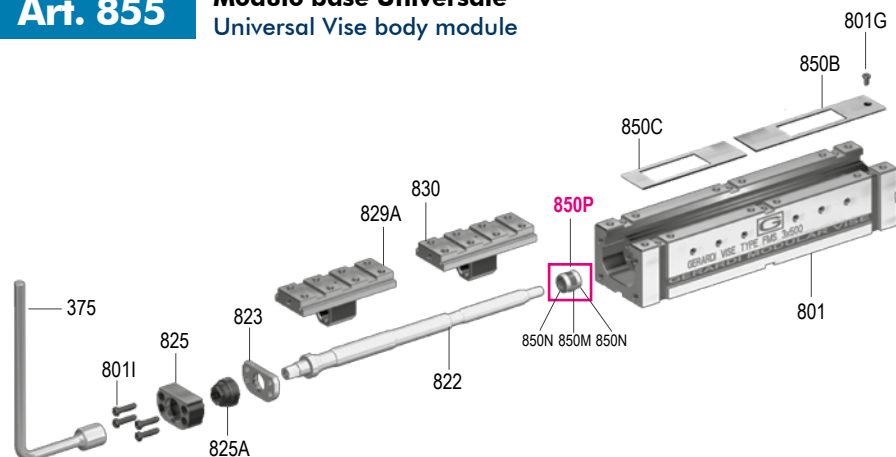
Art. 855
Modulo base Universale
 Universal Vise body module

Art.	Pag.	Art.	Pag.
375	4.35	850C	5.61
801	5.50	850P	5.72
801G	5.61	-	-
801I	5.61	-	-
822	5.53	-	-
823	5.59	-	-
825	5.59	-	-
825A	5.61	-	-
829A	5.52	-	-
830	5.52	-	-
850B	5.61	-	-

Tipo (grandezza) morsa / Vise type (size)	kN	1		2				3	
		25 kN		25 kN				30 kN	
Apertura massima / Maximum opening	A	2 x 16	2 x 66	2 x 54	2 x 104	2 x 154	2 x 204	2 x 74	2 x 124
Art. 860 Morsa FMS doppia, singola, autocentrante con ganasce zigrinate	B	25		30				40	
	C	70		90				100	
	D	232	332	300	400	500	600	400	500
	E	249	349	320	420	520	620	425	525
	G	75		95				125	
	J	56		64				84	
	W	74		94				124	
	kg	9	12	22	29	35	42	44	49
	Cod.	5.86.01200	5.86.01300	5.86.02300	5.86.02400	5.86.02500	5.86.02600	5.86.03400	5.86.03500

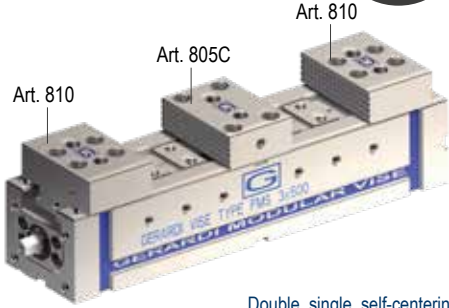

Double, single, self-centering FMS vise with serrated jaws

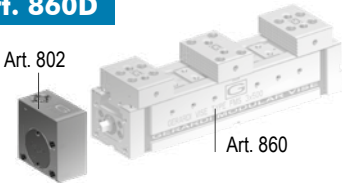

5

Art. 860D

(Art. 860 + 802) Morsa + moltiplicatore di coppia / Vise + torque multiplier

Cod.	5.86.0D120	5.86.0D130	5.86.0D230	5.86.0D240	5.86.0D250	5.86.0D260	5.86.0D340	5.86.0D350
------	------------	------------	------------	------------	------------	------------	------------	------------

Moltiplicatore di coppia con rinvio angolare - Mechanical with torque multiplier with angular transmission

Cod.	5.80.21000	5.80.22000	5.80.23000
------	------------	------------	------------

Art. 802

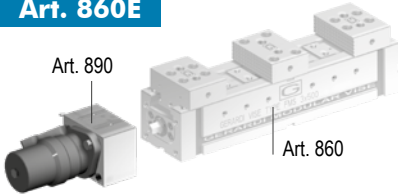
Art. 860E

(Art. 860 + 890) Morsa + motore idraulico / Vise + hydraulic motor

Cod.	5.86.0E120	5.86.0E130	5.86.0E230	5.86.0E240	5.86.0E250	5.86.0E260	5.86.0E340	5.86.0E350
------	------------	------------	------------	------------	------------	------------	------------	------------

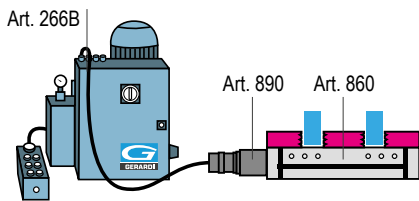
Art. 860F

(Art. 860 + 890 + 266B) Morsa + motore idraulico + centralina / Vise + hydraulic motor + power unit

Cod.	5.86.0F120	5.86.0F130	5.86.0F230	5.86.0F240	5.86.0F250	5.86.0F260	5.86.0F340	5.86.0F350
------	------------	------------	------------	------------	------------	------------	------------	------------

Dotazione standard:

- 2 arresti laterali Art. 370
- 1 coppia di tasselli di posizionamento per cava da 16 mm Art. 297
- 1 chiave a pipa Art. 375
- 1 piastrina di collegamento Art.801S

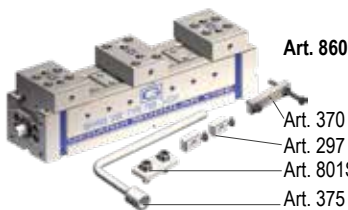
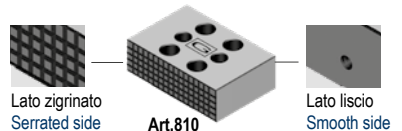

Standard equipment:

- 2 workstops Art. 370
- 1 pair of positioning key-nuts for 16 mm slot Art. 297
- 1 box wrench Art. 375
- 1 connecting plate Art.801S

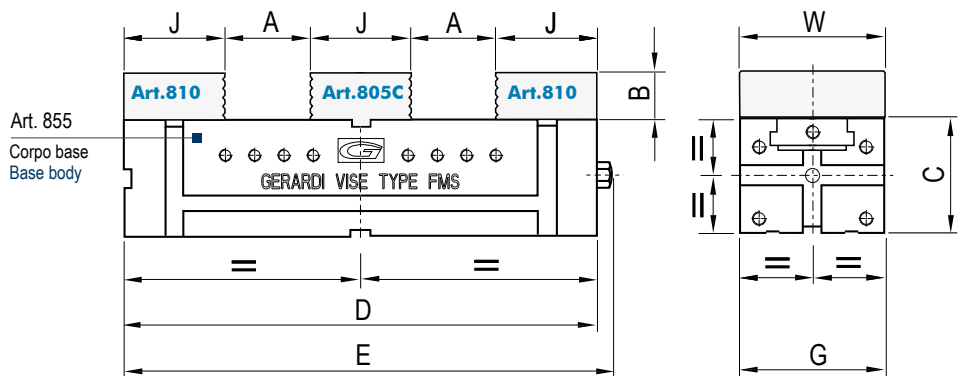

	3 30 kN			4 30 kN				5 32 kN			6 32 kN		
A	2 x 174	2 x 224	2 x 274	2 x 103	2 x 153	2 x 203	2 x 253	2 x 138	2 x 188	2 x 238	2 x 238	2 x 288	2 x 338
B	40			50				60			60		
C	100			120				140			160		
D	600	700	800	500	600	700	800	600	700	800	800	900	1000
E	625	725	825	525	625	725	825	625	725	825	825	925	1025
G	125			145				170			190		
J	84			98				108			108		
W	124			144				169			189		
kg	54	59	64	71	79	88	96	130	140	150	210	230	250
Cod.	5.86.03600	5.86.03700	5.86.03800	5.86.04500	5.86.04600	5.86.04700	5.86.04800	5.86.05600	5.86.05700	5.86.05800	5.86.06800	5.86.06900	5.86.06100

Art. 860D (Art. 860 + 802) Morsa + moltiplicatore di coppia / Vise + torque multiplier

Cod.	5.86.0D360	5.86.0D370	5.86.0D380	5.86.0D450	5.86.0D460	5.86.0D470	5.86.0D480	5.86.0D560	5.86.0D570	5.86.0D580	5.86.0D680	5.86.0D690	5.86.0D610
------	------------	------------	------------	------------	------------	------------	------------	------------	------------	------------	------------	------------	------------

Art. 802 Moltiplicatore di coppia con rinvio angolare - Mechanical with torque multiplier with angular transmission

Cod.	5.80.23000	5.80.24000	5.80.25000	5.80.26000
------	------------	------------	------------	------------

Art. 860E (Art. 860 + 890) Morsa + motore idraulico / Vise + hydraulic motor

Cod.	5.86.0E360	5.86.0E370	5.86.0E380	5.86.0E450	5.86.0E460	5.86.0E470	5.86.0E480	5.86.0E560	5.86.0E570	5.86.0E580	5.86.0E680	5.86.0E690	5.86.0E610
------	------------	------------	------------	------------	------------	------------	------------	------------	------------	------------	------------	------------	------------

Art. 860F (Art. 860 + 890 + 266B) Morsa + motore idraulico + centralina / Vise + hydraulic motor + power unit

Cod.	5.86.0F360	5.86.0F370	5.86.0F380	5.86.0F450	5.86.0F460	5.86.0F470	5.86.0F480	5.86.0F560	5.86.0F570	5.86.0F580	5.86.0F680	5.86.0F690	5.86.0F610
------	------------	------------	------------	------------	------------	------------	------------	------------	------------	------------	------------	------------	------------

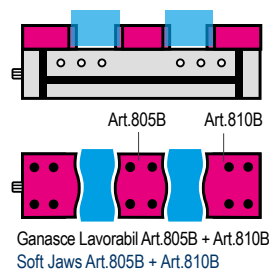
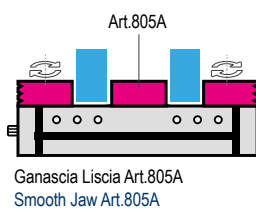
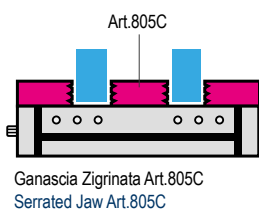
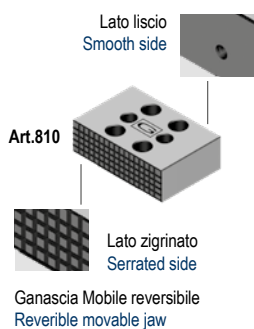
Art. 860 Esempi applicativi ganasce: / Jaw application examples:

Art.	Pag.
810	5.56
805C	5.54
805A	5.54
805B	5.54
810B	5.56

Tipo (grandezza) morsa / Vise type (size)	kN	1		2				3	
		25 kN		25 kN				30 kN	
Apertura massima / Maximum opening	A	2 x 60	2 x 110	2 x 118	2 x 168	2 x 218	2 x 268	2 x 162	2 x 212
Art. 863 Morsa FMS doppia, singola, autocentrante con ganasce a gradino 	B	25		30				40	
	C	70		90				100	
	D	232	332	300	400	500	600	400	500
	E	249	349	320	420	520	620	425	525
	G	75		95				125	
	J	56		64				84	
	J1	22		24				30	
	J2	16		16				16	
	W	74		94				124	
	kg	8	11	20	27	33	40	40	45
	Cod.	5.86.31200	5.86.31300	5.86.32300	5.86.32400	5.86.32500	5.86.32600	5.86.33400	5.86.33500

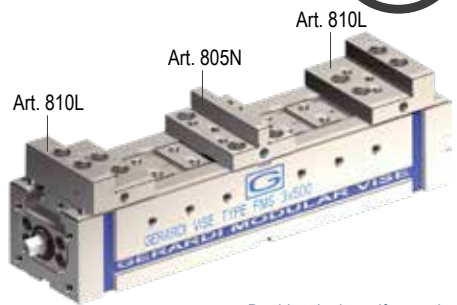

Double, single, self-centering FMS vise with step jaws

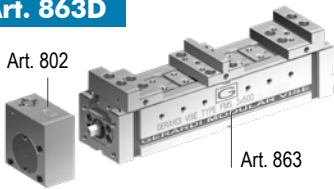
Art. 863D

(Art. 863 + 802) Morsa + moltiplicatore di coppia / Vise + torque multiplier

Cod.	5.86.3D120	5.86.3D130	5.86.3D230	5.86.3D240	5.86.3D250	5.86.3D260	5.86.3D340	5.86.3D350
------	------------	------------	------------	------------	------------	------------	------------	------------

Moltiplicatore di coppia con rinvio angolare - Mechanical with torque multiplier with angular transmission

Cod.	5.80.21000	5.80.22000	5.80.23000
------	------------	------------	------------

Art. 802

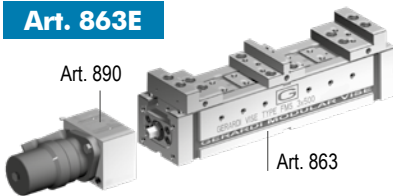
Art. 863E

(Art. 863 + 890) Morsa + motore idraulico / Vise + hydraulic motor

Cod.	5.86.3E120	5.86.3E130	5.86.3E230	5.86.3E240	5.86.3E250	5.86.3E260	5.86.3E340	5.86.3E350
------	------------	------------	------------	------------	------------	------------	------------	------------

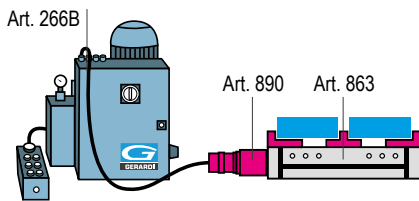
Art. 863F

(Art. 863 + 890 + 266B) Morsa + motore idraulico + centralina / Vise + hydraulic motor + power unit

Cod.	5.86.3F120	5.86.3F130	5.86.3F230	5.86.3F240	5.86.3F250	5.86.3F260	5.86.3F340	5.86.3F350
------	------------	------------	------------	------------	------------	------------	------------	------------

Dotazione standard:

- 2 arresti laterali Art. 370
- 1 coppia di tasselli di posizionamento per cava da 16 mm Art. 297
- 1 chiave a pipa Art. 375
- 1 piastrina di collegamento Art.801S

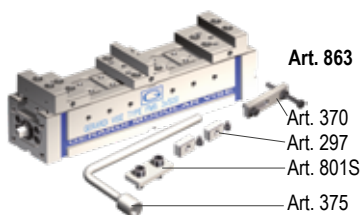

Standard equipment:

- 2 workstops Art. 370
- 1 pair of positioning key-nuts for 16 mm slot Art. 297
- 1 box wrench Art. 375
- 1 connecting plate Art.801S

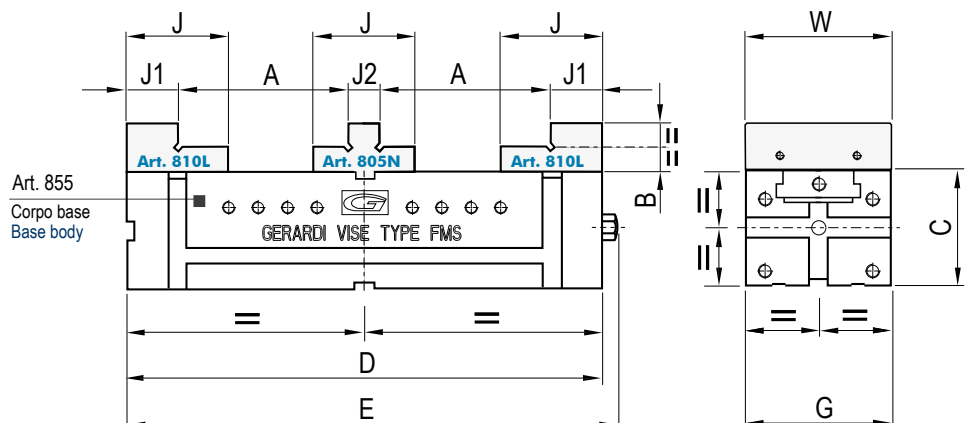

	3 30 kN			4 30 kN				5 32 kN			6 32 kN		
A	2 x 262	2 x 312	2 x 362	2 x 204	2 x 254	2 x 304	2 x 354	2 x 254	2 x 304	2 x 354	2 x 354	2 x 404	2 x 454
B		40				50				60		60	
C		100				120				140		160	
D	600	700	800	500	600	700	800	600	700	800	800	900	1000
E	625	725	825	525	625	725	825	625	725	825	825	925	1025
G		125				145				170		190	
J		84				98				108		108	
J1		30				38				38		38	
J2		16				16				16		16	
W		124				144				169		189	
kg	50	55	60	68	76	85	93	124	134	144	200	220	240

Cod. 5.86.33600 5.86.33700 5.86.33800 5.86.34500 5.86.34600 5.86.34700 5.86.34800 5.86.35600 5.86.35700 5.86.35800 5.86.36800 5.86.36900 5.86.36100

Art. 863D (Art. 863 + 802) Morsa + moltiplicatore di coppia / Vise + torque multiplier

Cod. 5.86.3D360 5.86.3D370 5.86.3D380 5.86.3D450 5.86.3D460 5.86.3D470 5.86.3D480 5.86.3D560 5.86.3D570 5.86.3D580 5.86.3D680 5.86.3D690 5.86.3D610

Art. 802 Moltiplicatore di coppia con rinvio angolare - Mechanical with torque multiplier with angular transmission

Cod. 5.80.23000 5.80.24000 5.80.25000 5.80.26000

Art. 863E (Art. 863 + 890) Morsa + motore idraulico / Vise + hydraulic motor

Cod. 5.86.3E360 5.86.3E370 5.86.3E380 5.86.3E450 5.86.3E460 5.86.3E470 5.86.3E480 5.86.3E560 5.86.3E570 5.86.3E580 5.86.3E680 5.86.3E690 5.86.3E610

Art. 863F (Art. 863 + 890 + 266B) Morsa + motore idraulico + centralina / Vise + hydraulic motor + power unit

Cod. 5.86.3F360 5.86.3F370 5.86.3F380 5.86.3F450 5.86.3F460 5.86.3F470 5.86.3F480 5.86.3F560 5.86.3F570 5.86.3F580 5.86.3F680 5.86.3F690 5.86.3F610

Art. 863 Esempi applicativi ganasce: Jaw application examples:

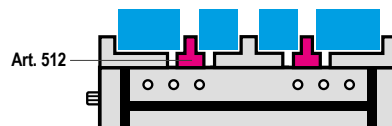

Serraggio simultaneo di 4 pezzi con ganaschia intermedia
 4 Workpieces simultaneous clamping with intermediate jaw

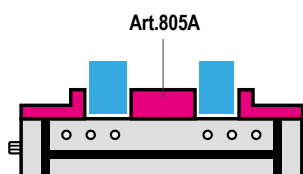

Ganasce lisce per fissaggio centrale
 Smooth jaws for central fixed

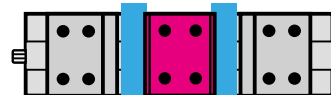
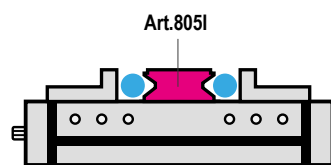

Ganaschia prismatica orizzontale per fissaggio centrale
 Horizontal prismatic jaws for central fixed

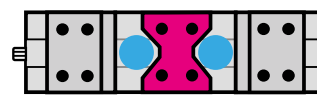
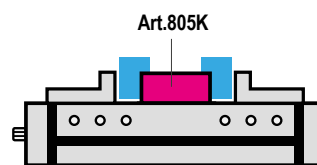

Ganaschia prismatica verticale per fissaggio centrale
 Vertical prismatic jaw for central fixed

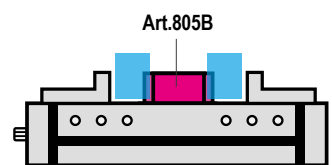

Ganaschia lavorabile per fissaggio centrale
 Soft jaws for central fixed

Tipo (grandezza) morsa / Vise type (size)	kN	1		2				3	
		25 kN		25 kN				30 kN	
Apertura massima / Maximum opening	A	2 x 32	2 x 82	2 x 54	2 x 104	2 x 154	2 x 204	2 x 77	2 x 127
Art. 864 Morsa FMS doppia, singola, autocentrante con ganasce a doppio gradino Double, single, self-centering FMS vise with double step jaws	A1	2 x 84	2 x 134	2 x 118	2 x 168	2 x 218	2 x 268	2 x 162	2 x 212
	B	25		30				40	
	C	70		90				100	
	D	232	332	300	400	500	600	400	500
	E	249	349	320	420	520	620	425	525
	G	75		95				125	
	J	56		64				84	
	J1	24		24				30	
	J2	16		16				16	
	W	74		94				124	
	kg	8	11	20	27	33	40	40	45
	Cod.	5.86.41200	5.86.41300	5.86.42300	5.86.42400	5.86.42500	5.86.42600	5.86.43400	5.86.43500

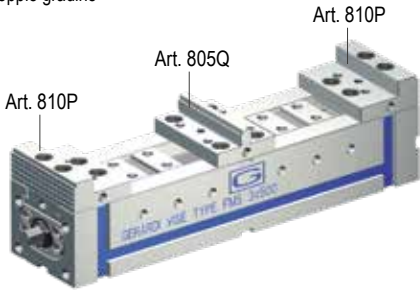

Double, single, self-centering FMS vise with double step jaws

Art. 805F

 Ganasce fissa con doppio gradino 3x5 LISCIA
 Fixed jaw with double 3x5 step SMOOTH



Cod.	5.80.5F100	5.80.5F200	5.80.5F300
------	------------	------------	------------

Art. 805G

 Ganasce fissa con doppio gradino 3x5 ZIGRINATA
 Fixed jaw with double 3x5 step SERRATED

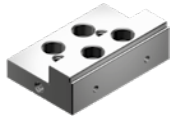

Cod.	5.80.5G100	5.80.5G200	5.80.5G300
------	------------	------------	------------

Art. 8100

 Ganasce mobile con gradino piccolo e grande
 Movable jaw with small and large step

Cod.	5.81.00100	5.81.00200	5.81.00300
------	------------	------------	------------

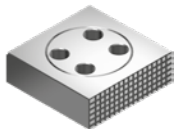
Art. 810X

 Ganasce mobile oscillante con gradino 3x5 zigrinata da un lato con albero a gradino (Art. 810Z)
 Floating movable jaw with 3x5 step one side serrated with step block pin (Art. 810Z)

Cod.	5.81.0X100	5.81.0X200	5.81.0X300
------	------------	------------	------------

Dotazione standard:

- 2 arresti laterali Art. 370
- 1 coppia di tasselli di posizionamento per cava da 16 mm Art. 297
- 1 chiave a pipa Art. 375
- 1 piastrina di collegamento Art.801S

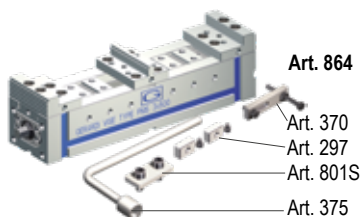
Standard equipment:

- 2 workstops Art. 370
- 1 pair of positioning key-nuts for 16 mm slot Art. 297
- 1 box wrench Art. 375
- 1 connecting plate Art.801S

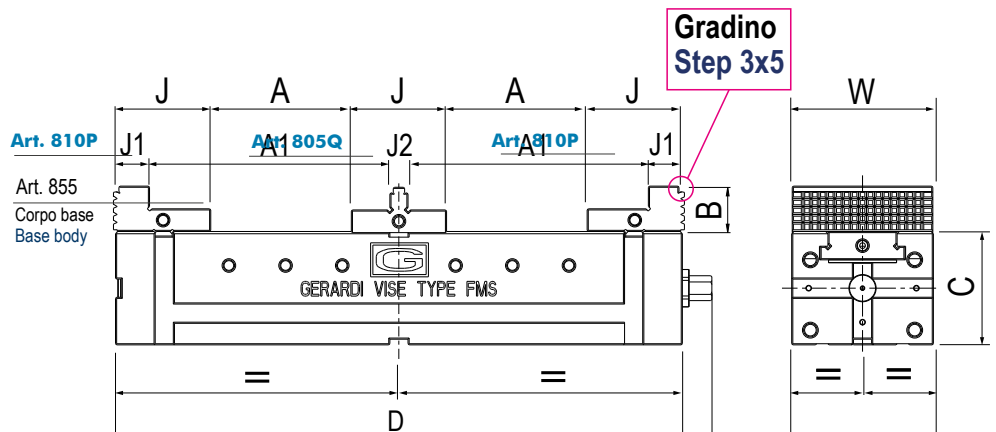

	3 30 kN			4 30 kN				5 32 kN			6 32 kN		
A	2 x 177	2 x 227	2 x 277	2 x 103	2 x 153	2 x 203	2 x 253	2 x 138	2 x 188	2 x 238	2 x 238	2 x 288	2 x 338
A1	2 x 262	2 x 312	2 x 362	2 x 204	2 x 254	2 x 304	2 x 354	2 x 254	2 x 304	2 x 354	2 x 354	2 x 404	2 x 454
B	40			50				60			60		
C	100			120				140			160		
D	600	700	800	500	600	700	800	600	700	800	800	900	1000
E	625	725	825	525	625	725	825	625	725	825	825	925	1025
G	125			145				170			190		
J	84			98				108			108		
J1	30			38				38			38		
J2	16			16				16			16		
W	124			144				169			189		
kg	50	55	60	68	76	85	93	124	134	144	200	220	240

Cod. 5.86.43600 5.86.43700 5.86.43800 5.86.44500 5.86.44600 5.86.44700 5.86.44800 5.86.45600 5.86.45700 5.86.45800 5.86.46800 5.86.46900 5.86.46100

Art. 805F

Cod. 5.80.5F300 5.80.5F400 5.80.5F500 5.80.5F300

Art. 805G

Cod. 5.80.5G300 5.80.5G400 5.80.5G500 5.80.5G600

Art. 810O

Cod. 5.81.0O300 5.81.0O400 5.81.0O500 5.81.0O600

Art. 810X

Cod. 5.81.0X300 5.81.0X400 5.81.0X500 5.81.0X600

Art. 864

Esempi applicativi ganasce a doppio gradino:
 Double step jaw application examples:

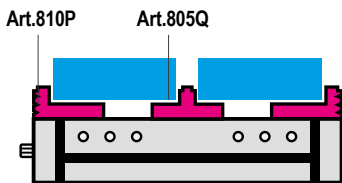

Utilizzo del gradino standard per alzare il particolare rispetto alla base
 Use the main step for raising the workpiece

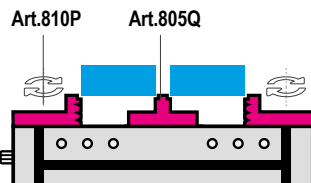

Per utilizzare il 2° gradino (3x5) ruotare le ganasce mobili di 180°
 In order to use the second 3x5mm step turn the movable jaw 180°

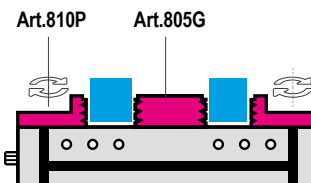

Per sfruttare il lato zigrinato delle ganasce mobili Art.810P sostituisci la ganascia fissa centrale con l'Art.805G
 To exploit the serrated side of the movable jaws Art.810P change the fixed central jaw with Art.805G

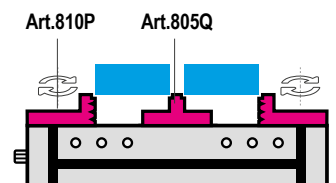

Per sfruttare il lato zigrinato delle ganasce mobili Art.810P sostituisci la ganascia fissa centrale con l'Art.805Q

Tipo (grandezza) morsa / Vise type (size)	kN	1		2			3	
		25 kN		25 kN			30 kN	
Apertura massima / Maximum opening	A	2 x 52	2 x 30	2 x 80	2 x 130	2 x 180	2 x 46	2 x 96
Art. 865	B	25		30			40	
	C	70		90			100	
	D	332	300	400	500	600	400	500
	E	349	320	420	520	620	425	525
	G	75		95			125	
	J	63		76			98	
	J1	70		88			111	
	W	74		94			124	
	kg	12	23	30	36	43	46	51
	Cod.	5.86.51300	5.86.52300	5.86.52400	5.86.52500	5.86.52600	5.86.53400	5.86.53500



Morsa FMS doppia, singola, autocentrante con ganasce a cambio rapido discendente (sistema a pettine)

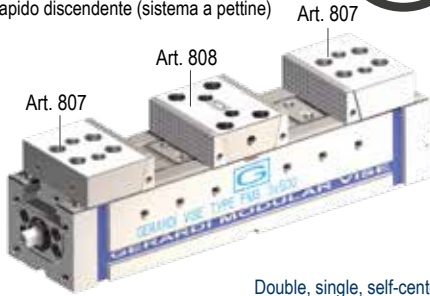

Double, single, self-centering FMS vise with quick change pull down jaws (comb system)

Art. 865D (Art. 865 + 802) Morsa + moltiplicatore di coppia / Vise + torque multiplier

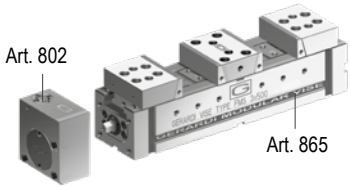

Cod.	5.86.5D130	5.86.5D230	5.86.5D240	5.86.5D250	5.86.5D260	5.86.5D340	5.86.5D350
------	------------	------------	------------	------------	------------	------------	------------

Moltiplicatore di coppia con rinvio angolare - Mechanical with torque multiplier with angular transmission

Art. 802



Cod.	5.80.21000	5.80.22000	5.80.23000
------	------------	------------	------------

Art. 865E

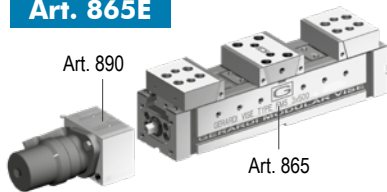

(Art. 865 + 890) Morsa + motore idraulico / Vise + hydraulic motor

Cod.	5.86.5E130	5.86.5E230	5.86.5E240	5.86.5E250	5.86.5E260	5.86.5E340	5.86.5E350
------	------------	------------	------------	------------	------------	------------	------------

Art. 865F

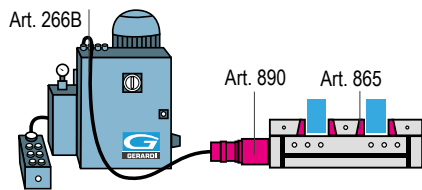

(Art. 865 + 890 + 266B) Morsa + motore idraulico + centralina / Vise + hydraulic motor + power unit

Cod.	5.86.5F130	5.86.5F230	5.86.5F240	5.86.5F250	5.86.5F260	5.86.5F340	5.86.5F350
------	------------	------------	------------	------------	------------	------------	------------

Dotazione standard:

- 2 arresti laterali Art. 370
- 1 coppia di tasselli di posizionamento per cava da 16 mm Art. 297
- 1 chiave a pipa Art. 375
- 1 piastrina di collegamento Art.801S

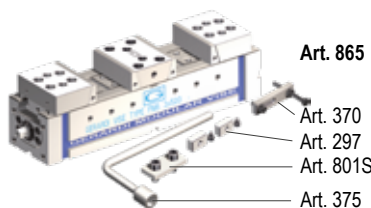

Standard equipment:

- 2 workstops Art. 370
- 1 pair of positioning key-nuts for 16 mm slot Art. 297
- 1 box wrench Art. 375
- 1 connecting plate Art.801S

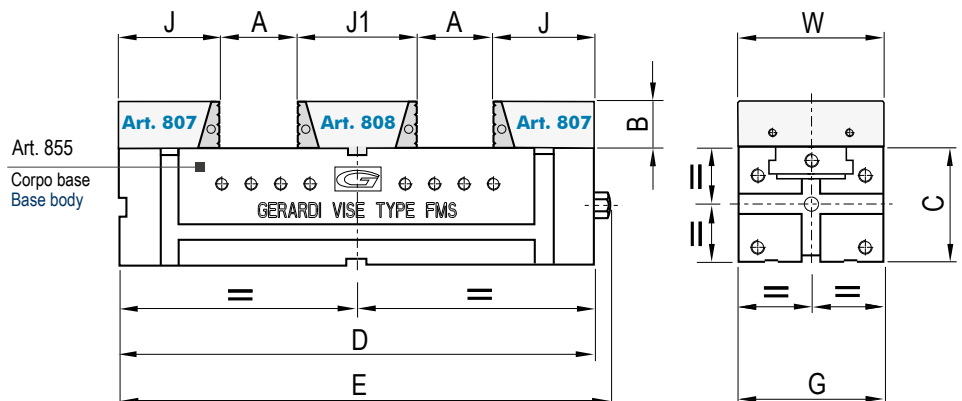

	3 30 kN			4 30 kN				5 32 kN			6 32 kN		
A	2 x 146	2 x 196	2 x 246	2 x 65	2 x 115	2 x 165	2 x 215	2 x 90	2 x 140	2 x 190	2 x 216	2 x 256	2 x 316
B	40			50				60			60		
C	100			120				140			160		
D	600	700	800	500	600	700	800	600	700	800	800	900	1000
E	625	725	825	525	625	725	825	625	725	825	825	925	1025
G	125			145				170			190		
J	98			117				132			119		
J1	111			136				155			130		
W	124			144				169			189		
kg	54	59	64	74	82	91	99	134	144	154	215	235	255

Cod. 5.86.53600 5.86.53700 5.86.53800 5.86.54500 5.86.54600 5.86.54700 5.86.54800 5.86.55600 5.86.55700 5.86.55800 5.86.56800 5.86.56900 5.86.56100

Art. 865D (Art. 865 + 802) Morsa + moltiplicatore di coppia / Vise + torque multiplier

Cod. 5.86.5D360 5.86.5D370 5.86.5D380 5.86.5D450 5.86.5D460 5.86.5D470 5.86.5D480 5.86.5D560 5.86.5D570 5.86.5D580 5.86.5D680 5.86.5D690 5.86.5D610

Art. 802 Moltiplicatore di coppia con rinvio angolare - Mechanical with torque multiplier with angular transmission

Cod. 5.80.23000 5.80.24000 5.80.25000 5.80.26000

Art. 865E (Art. 865 + 890) Morsa + motore idraulico / Vise + hydraulic motor

Cod. 5.86.5E360 5.86.5E370 5.86.5E380 5.86.5E450 5.86.5E460 5.86.5E470 5.86.5E480 5.86.5E560 5.86.5E570 5.86.5E580 5.86.5E680 5.86.5E690 5.86.5E610

Art. 865F (Art. 865 + 890 + 266B) Morsa + motore idraulico + centralina / Vise + hydraulic motor + power unit

Cod. 5.86.5F360 5.86.5F370 5.86.5F380 5.86.5F450 5.86.5F460 5.86.5F470 5.86.5F480 5.86.5F560 5.86.5F570 5.86.5F580 5.86.5F680 5.86.5F690 5.86.5F610

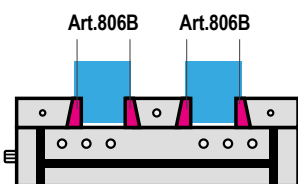
Art. 865 Esempi applicativi piastre ganasce: / Jaw plates application examples:

Piastre ganasce lavorabili Art.806B
Soft machineable Jaw plates Art.806B

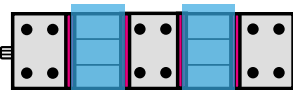
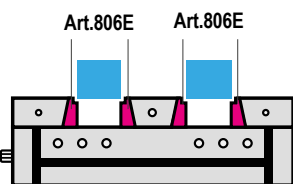

Piastre ganasce a gradino Art.806E
Step jaw plates Art.806E

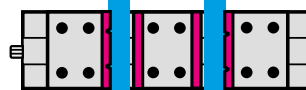
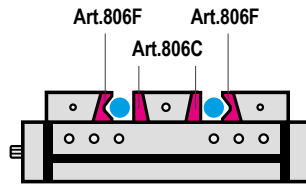

2 piastre ganasce Art.806F + 2 Art.806C
2 jaw plates Art.806F + 2 Art.806C

Configurazione standard / Standard configuration

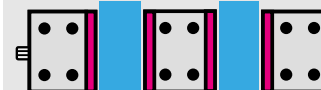
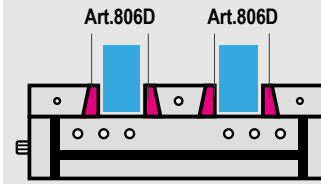

Piastre ganasce zigrinate Art.806D
Serrated jaw plates Art.806D

CORPI GANASCE FMS & PIASTRE GANASCE INTERCAMBIABILI RAPIDE

FMS COMB JAW BODIES & QUICK INTERCHANGEABLE JAW PLATES

Tipo (grandezza) / Type (size)	1	2	3	4	5	6	
Art. 806* Ganaschia fissa con piastra ganaschia zigrinata intercambiabile rapida Fixed jaw with quick interchangeable serrated jaw plate		Cod. 5.80.61000	5.80.62000	5.80.63000	5.80.64000	5.80.65000	5.80.66000
* Viti per fissaggio a richiesta Fixing screws on request							
Art. 807* Ganaschia mobile con piastra ganaschia zigrinata intercambiabile rapida Movable jaw with quick interchangeable serrated jaw plate		Cod. 5.80.71000	5.80.72000	5.80.73000	5.80.74000	5.80.75000	5.80.76000
* Viti per fissaggio a richiesta Fixing screws on request							
Art. 808* Ganaschia fissa doppia con piastre ganasche zigrinate intercambiabili rapide Double fixed jaw with quick interchangeable serrated jaw plate		Cod. 5.80.81000	5.80.82000	5.80.83000	5.80.84000	5.80.85000	5.80.86000
* Viti per fissaggio a richiesta Fixing screws on request							
Art. 806A Corpo ganaschia fissa per piastra ganaschia intercambiabile rapida Fixed jaw body for quick interchangeable jaw plate		Cod. 5.80.6A100	5.80.6A200	5.80.6A300	5.80.6A400	5.80.6A500	5.80.6A600
Art. 807A Corpo ganaschia mobile per piastra ganaschia intercambiabile rapida Movable jaw body for quick interchangeable jaw plate		Cod. 5.80.7A100	5.80.7A200	5.80.7A300	5.80.7A400	5.80.7A500	5.80.7A600
Art. 808A Corpo ganaschia fissa doppia per piastre ganasche intercambiabili rapide Double fixed jaw body for quick interchangeable jaw plate		Cod. 5.80.8A100	5.80.8A200	5.80.8A300	5.80.8A400	5.80.8A500	5.80.8A600
Art. 808B Corpo ganaschia fissa doppia ridotta per piastre ganasche intercambiabili rapide Double fixed jaw body narrow for quick interchangeable jaw plate		Cod. 5.80.8B100	5.80.8B200	5.80.8B300	5.80.8B400	5.80.8B500	5.80.8B600

5

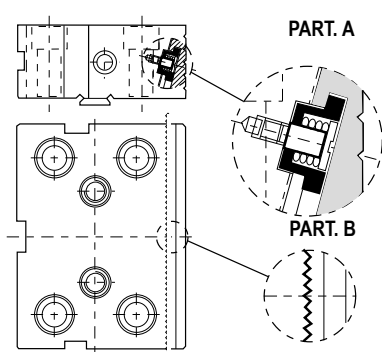

RAPIDA SOSTITUZIONE DELLE PIASTRE GANASCE DISCENDENTI SENZA BISOGNO DI ALCUN UTENSILE

Il nuovo sistema con piastre ganasche intercambiabili, conferisce alla morsa FMS un ulteriore aumento di flessibilità dato dalla rapidità di sostituzione delle piastre ganasche e dalla precisione di riposizionamento. La rapidità di sostituzione delle piastre ganasche è resa possibile dal nuovo sistema con perno a molla (PART. A), mentre le righe prismatiche (PART. B) effettuate con mola sagomata sui piani d'appoggio rendono possibile un riposizionamento di elevata precisione. La vasta gamma di piastre ganasche intercambiabili va a soddisfare le più svariate esigenze di lavorazione.

QUICK HAND CHANGE OF PULL-DOWN JAW PLATES - NO TOOLS NEEDED

The new system with quick interchangeable jaw plates, increase the FMS vise flexibility, and feature the quick jaw plates replacement and their high precision repositioning. The quickness of the jaw plates replacement is allowed by the new system of pin with spring (PART. A), while the prismatic grooves (PART. B), made with shaped grind wheel on the surface plates, allow a perfect repositioning. The wide range of interchangeable jaws plates can satisfy the most varied workholding needs.

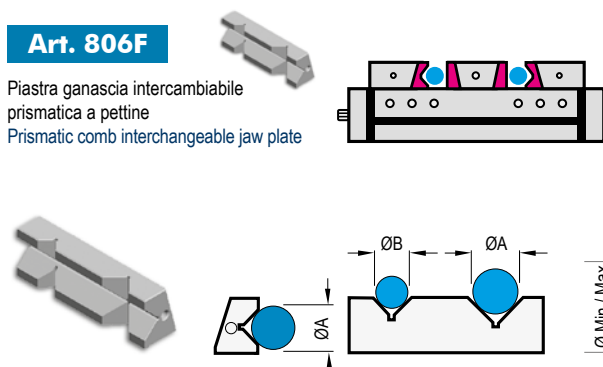

Solo 2 per morsa!! Just 2 pcs each vise!!						
Cod.	5.80.6F100	5.80.6F200	5.80.6F300	5.80.6F400	5.80.6F500	5.80.6F600

Piastra ganaschia intercambiabile prismatica a pettine
 Per serraggi autocentranti è necessario ordinare n. 2 piastrine prismatiche
 Prismatic comb interchangeable jaw plate
 For self-centering clamping is necessary to order n. 2 prismatic jaws

Ø Min / Max	A	B	1	2	3	4	5	6
A	6 / 16	9 / 24	13 / 38	15 / 40	15 / 42	15 / 42		
B	4 / 10	7 / 18	9 / 24	9 / 24	9 / 24	9 / 24		

PIASTRE GANASCE INTERCAMBIABILI RAPIDE

QUICK INTERCHANGEABLE JAW PLATES

Tipo (grandezza) / Type (size)	1	2	3	4	5	6
W	73	93	123	143	168	188
B	25	30	40	50	60	60
C	10	10	11	11	16	16

Art. 806B

Piastra ganascia intercambiabile dolce a pettine
Soft comb interchangeable jaw plate

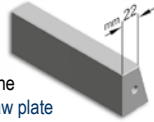

Cod.	5.80.6B100	5.80.6B200	5.80.6B300	5.80.6B400	5.80.6B500	5.80.6B600
------	------------	------------	------------	------------	------------	------------

Art. 806C

Piastra ganascia intercambiabile liscia a pettine
Smooth comb interchangeable jaw plate

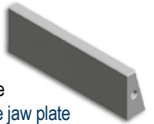

Cod.	5.80.6C100	5.80.6C200	5.80.6C300	5.80.6C400	5.80.6C500	5.80.6C600
------	------------	------------	------------	------------	------------	------------

Art. 806D

Piastra ganascia intercambiabile zigrinata a pettine
Serrated comb interchangeable jaw plate

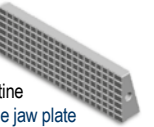

Cod.	5.80.6D100	5.80.6D200	5.80.6D300	5.80.6D400	5.80.6D500	5.80.6D600
------	------------	------------	------------	------------	------------	------------

Art. 806E

Piastra ganascia intercambiabile a gradino a pettine
Step comb interchangeable jaw plate

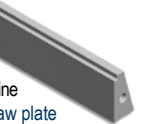

Cod.	5.80.6E100	5.80.6E200	5.80.6E300	5.80.6E400	5.80.6E500	5.80.6E600
------	------------	------------	------------	------------	------------	------------

KIT RISPARMIO - SAVING KIT

Piastra ganascia intercambiabile a gradino a pettine (SET di coppie)
Step comb interchangeable jaw plate (SET of pair)

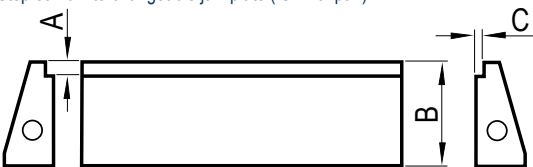

A	Set di 8 pezzi Set of 8 pcs.		Set di 10 pezzi Set of 10 pcs.		Set di 14 pezzi Set of 14 pcs.		Set di 14 pezzi Set of 14 pcs.		Set di 14 pezzi Set of 14 pcs.	
	3	5	3	5	3	5	3	5	3	5
	8	13	8	13	8	13	8	13	8	13
	-	-	-	-	18	18	18	18	18	18
B	25	30	40	50	60	60				
C	3	3	3	3	3	3				
Cod.	5.80.6E112	5.80.6E212	5.80.6E312	5.80.6E412	5.80.6E512	5.80.6E612				

Art. 806SLD

Piastra ganascia scaricata a pettine
Discharged comb interchangeable jaw plate

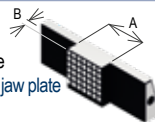

A	28	38	48	58	63	95
B	12	12	12	12	12	12
C	14	18	32	42	47	79
H	8	8	8	8	8	8

Art. 806SLE

Piastra ganascia con gradino scaricata a pettine
Discharged step comb interchangeable jaw plate

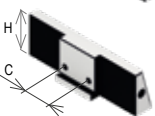

Cod.	5.80.6SLD1	5.80.6SLD2	5.80.6SLD3	5.80.6SLD4	5.80.6SLD5	5.80.6SLD6
Cod.	5.80.6SLE1	5.80.6SLE2	5.80.6SLE3	5.80.6SLE4	5.80.6SLE5	5.80.6SLE6

Art. 806K

Piastra ganascia intercambiabile a gradino a pettine con inserti GRIP
Comb interchangeable step jaw plate with GRIP inserts

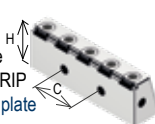

C	14	18	32	42	47	79
H	23	33	43	53	58	73
Cod.	5.80.6K100	5.80.6K200	5.80.6K300	5.80.6K400	5.80.6K500	5.80.6K600

Art. 806G

Piastra ganascia intercambiabile a pettine con arresto a 90°
90° interchangeable comb jaw plate

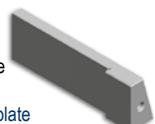

Solo 2 per morsa!! Just 2 pcs each vise!!

Cod.	5.80.6G100	5.80.6G200	5.80.6G300	5.80.6G400	5.80.6G500	5.80.6G600
------	------------	------------	------------	------------	------------	------------

Art. 806H

Piastra ganascia intercambiabile bombata a pettine
Round comb interchangeable jaw plate

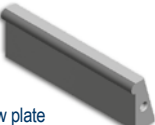

Cod.	5.80.6H100	5.80.6H200	5.80.6H300	5.80.6H400	5.80.6H500	5.80.6H600
------	------------	------------	------------	------------	------------	------------

Art. 806M

Piastra ganascia intercambiabile a pettine per angolo di 30° o 45°
30° or 45° angle interchangeable comb jaw plate

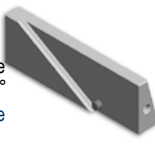

Solo 2 per morsa!! Just 2 pcs each vise!!

Cod.	5.80.6M100	5.80.6M200	5.80.6M300	5.80.6M400	5.80.6M500	5.80.6M600
------	------------	------------	------------	------------	------------	------------

Tipo (grandezza) morsa / Vise type (size)	kN	1			2			3	
		25 kN			25 kN			30 kN	
Apertura massima / Maximum opening	A	2 x 52	2 x 30	2 x 80	2 x 130	2 x 180	2 x 46	2 x 96	
Art. 866	B	25			30			40	
	C	70			90			100	
	D	332	300	400	500	600	400	500	
	E	349	320	420	520	620	425	525	
	G	75			95			125	
	J	63			76			98	
	J1	70			88			111	
	W	74			94			124	
	kg	12	23	30	36	43	46	51	
	Cod.	5.86.61300	5.86.62300	5.86.62400	5.86.62500	5.86.62600	5.86.63400	5.86.63500	

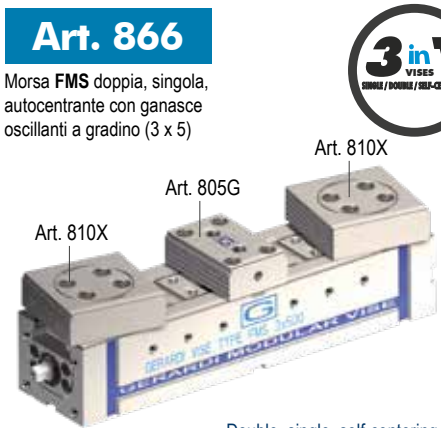

Double, single, self-centering FMS vise with floating step jaws (3 x 5)

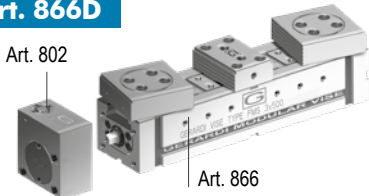
Art. 866D

(Art. 866 + 802) Morsa + moltiplicatore di coppia / Vise + torque multiplier

Cod.	5.86.6D130	5.86.6D230	5.86.6D240	5.86.6D250	5.86.6D260	5.86.6D340	5.86.6D350
------	------------	------------	------------	------------	------------	------------	------------

Moltiplicatore di coppia con rinvio angolare - Mechanical with torque multiplier with angular transmission

Cod.	5.80.21000	5.80.22000	5.80.23000
------	------------	------------	------------

Art. 802

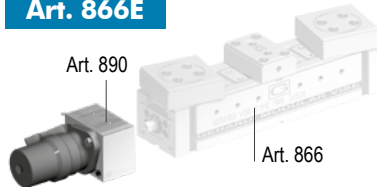
Art. 866E

(Art. 866 + 890) Morsa + motore idraulico / Vise + hydraulic motor

Cod.	5.86.6E130	5.86.6E230	5.86.6E240	5.86.6E250	5.86.6E260	5.86.6E340	5.86.6E350
------	------------	------------	------------	------------	------------	------------	------------

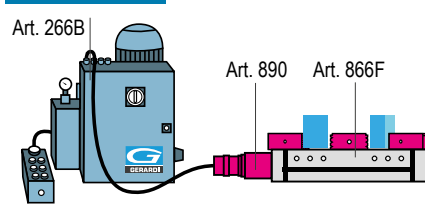
Art. 866F

(Art. 866 + 890 + 266B) Morsa + motore idraulico + centralina / Vise + hydraulic motor + power unit

Cod.	5.86.6F130	5.86.6F230	5.86.6F240	5.86.6F250	5.86.6F260	5.86.6F340	5.86.6F350
------	------------	------------	------------	------------	------------	------------	------------

Dotazione standard:

- 2 arresti laterali Art. 370
- 1 coppia di tasselli di posizionamento per cava da 16 mm Art. 297
- 1 chiave a pipa Art. 375
- 1 piastrina di collegamento Art.801S

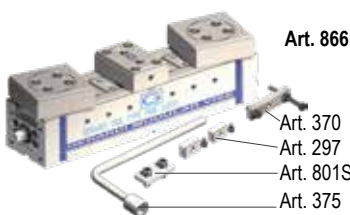

Standard equipment:

- 2 workstops Art. 370
- 1 pair of positioning key-nuts for 16 mm slot Art. 297
- 1 box wrench Art. 375
- 1 connecting plate Art.801S

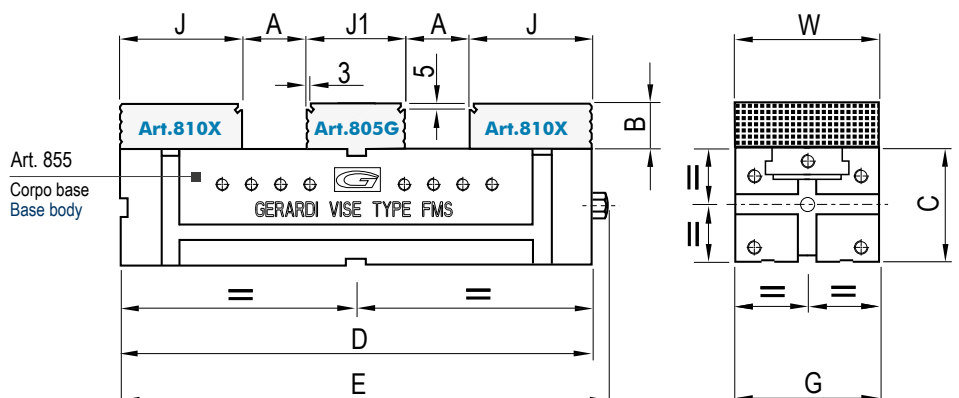
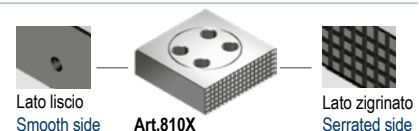

	3 30 kN			4 30 kN				5 32 kN			6 32 kN		
A	2 x 152	2 x 202	2 x 252	2 x 73	2 x 123	2 x 173	2 x 223	2 x 111	2 x 161	2 x 211	2 x 203	2 x 235	2 x 303
B	40			50				60			60		
C	100			120				140			160		
D	600	700	800	500	600	700	800	600	700	800	800	900	1000
E	625	725	825	525	625	725	825	625	725	825	825	925	1025
G	125			145				170			190		
J	106			128				135			143		
J1	84			98				108			108		
W	124			144				169			189		
kg	54	59	64	74	82	91	99	134	144	154	215	235	255

Cod. 5.86.63600 5.86.63700 5.86.63800 5.86.64500 5.86.64600 5.86.64700 5.86.64800 5.86.65600 5.86.65700 5.86.65800 5.86.66800 5.86.66900 5.86.66100

Art. 866D (Art. 866 + 802) Morsa + moltiplicatore di coppia / Vise + torque multiplier

Cod. 5.86.6D360 5.86.6D370 5.86.6D380 5.86.6D450 5.86.6D460 5.86.6D470 5.86.6D480 5.86.6D560 5.86.6D570 5.86.6D580 5.86.6D680 5.86.6D690 5.86.6D610

Art. 802 Moltiplicatore di coppia con rinvio angolare - Mechanical with torque multiplier with angular transmission

Cod. 5.80.23000 5.80.24000 5.80.25000 5.80.26000

Art. 866E (Art. 866 + 890) Morsa + motore idraulico / Vise + hydraulic motor

Cod. 5.86.6E360 5.86.6E370 5.86.6E380 5.86.6E450 5.86.6E460 5.86.6E470 5.86.6E480 5.86.6E560 5.86.6E570 5.86.6E580 5.86.6E680 5.86.6E690 5.86.6E610

Art. 866F (Art. 866 + 890 + 266B) Morsa + motore idraulico + centralina / Vise + hydraulic motor + power unit

Cod. 5.86.6F360 5.86.6F370 5.86.6F380 5.86.6F450 5.86.6F460 5.86.6F470 5.86.6F480 5.86.6F560 5.86.6F570 5.86.6F580 5.86.6F680 5.86.6F690 5.86.6F610

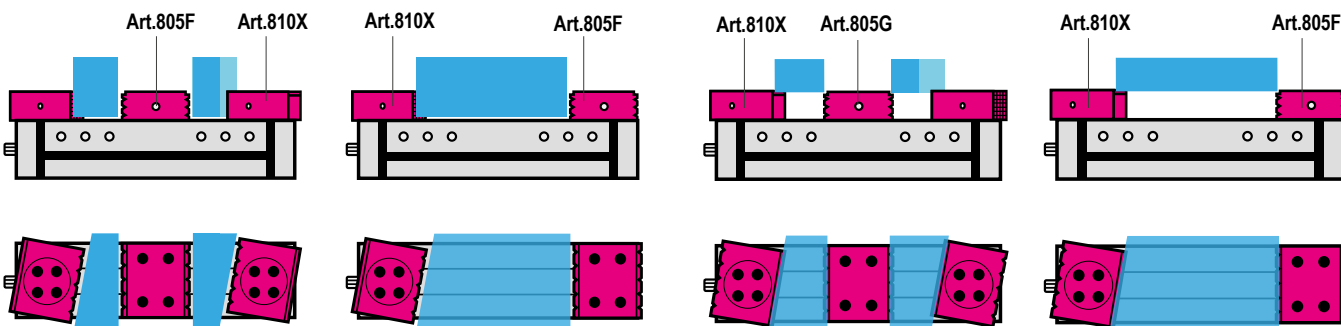
Art. 866 Esempi applicativi ganasce oscillanti:
 Floating Jaws application examples:

Serraggio di particolari grezzi - Rough workpieces clamping

Serraggio di particolari sul gradino - Rough workpieces clamping on step

FUNZIONAMENTO DELLE GANASCE MOBILI OSCILLANTI

THE OPERATION OF MOVABLE JAWS

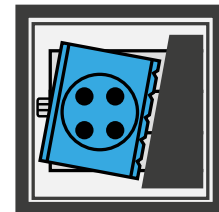

Art. 810Z

Albero a gradino per ganasce mobili oscillanti
Step block pin for floating movable jaw

Art. 810W

Ganascia mobile oscillante zigrinata da un lato, con albero a gradino (Art. 810Z)
Floating movable jaw one side serrated with step block pin (Art. 810Z)

Fig. 1 Pic. 1

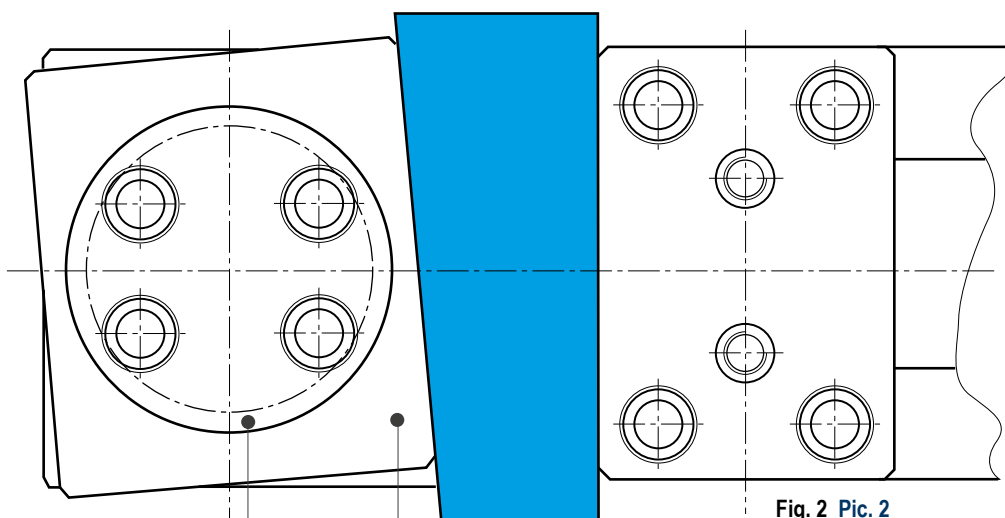
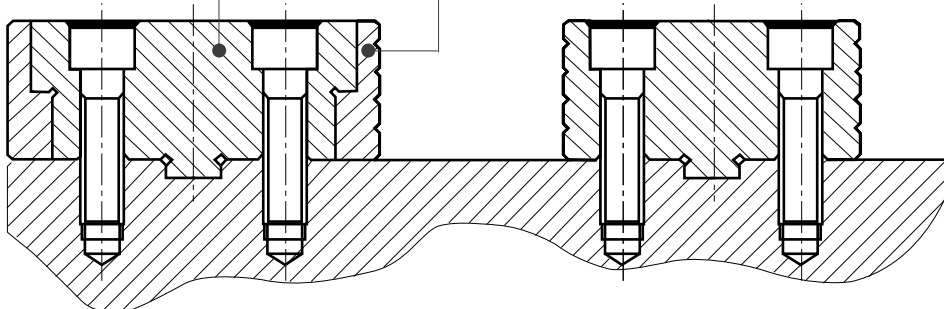

Fig. 2 Pic. 2

Art. 810Z

Albero a gradino per ganasce mobili oscillanti
Step block pin for floating movable jaw

Art. 810W

Ganascia mobile oscillante zigrinata da un lato, con albero a gradino (Art. 810Z)
Floating movable jaw one side serrated with step block pin (Art. 810Z)

Le ganasce mobili oscillanti consentono il serraggio di pezzi di forma irregolare i cui lati non risultino paralleli (Fig. 2). Questo è reso possibile dall'albero a gradino (Art. 810Z - Fig. 1), posto al centro della ganascia, che pur permettendo la rotazione della ganascia, ne mantiene la precisione ed evita il sollevamento del pezzo mentre viene lavorato. Il tutto a garanzia di un serraggio in piena sicurezza.

Floating movable jaws allow to clamp workpieces with irregular shapes whose sides are not parallel (Pic. 2). In fact thanks to the step block spindle (Art. 810Z - Pic. 1), positioned in the centre of the jaw body, the jaw can float and guarantee at the same time maximum precision and no tilting of the parts while being worked. The safety of the workholding is guaranteed.

GANASCE MOBILI OSCILLANTI

FLOATING MOVABLE JAWS

Tipo (grandezza) / Type (size)	1	2	3	4	5	6
Art. 810W* Ganasce mobile oscillante zigrinata da un lato con albero a gradino (Art. 810Z) Floating movable jaw one side serrated with step block pin (Art. 810Z)	Cod. 5.81.0W100	5.81.0W200	5.81.0W300	5.81.0W400	5.81.0W500	5.81.0W600
Art. 810X* Ganasce mobile oscillante con gradino 3x5 zigrinata da un lato con albero a gradino (Art. 810Z) Floating movable jaw with 3x5 step one side serrated with step block pin (Art. 810Z)	Cod. 5.81.0X100	5.81.0X200	5.81.0X300	5.81.0X400	5.81.0X500	5.81.0X600
Art. 810Y* Ganasce mobile oscillante con gradino 3x5 con albero a gradino (Art. 810Z) Floating movable jaw with 3x5 step with step block pin (Art. 810Z)	Cod. 5.81.0Y100	5.81.0Y200	5.81.0Y300	5.81.0Y400	5.81.0Y500	5.81.0Y600
Art. 810Z Albero a gradino per ganasce mobili oscillanti Step block pin for floating movable jaw	Cod. 5.81.0Z100	5.81.0Z200	5.81.0Z300	5.81.0Z400	5.81.0Z500	5.81.0Z600
Art. 810WA Corpo ganasce mobile oscillante zigrinata da un lato Body floating movable jaw one side serrated	Cod. 5.81.0WA10	5.81.0WA20	5.81.0WA30	5.81.0WA40	5.81.0WA50	5.81.0WA60
Art. 810XA Corpo ganasce mobile oscillante con gradino 3x5 zigrinata da un lato Body floating movable jaw with 3x5 step one side serrated	Cod. 5.81.0XA10	5.81.0XA20	5.81.0XA30	5.81.0XA40	5.81.0XA50	5.81.0XA60
Art. 810YA Corpo ganasce mobile oscillante con gradino 3x5 Body floating movable jaw with 3x5 step	Cod. 5.81.0YA10	5.81.0YA20	5.81.0YA30	5.81.0YA40	5.81.0YA50	5.81.0YA60

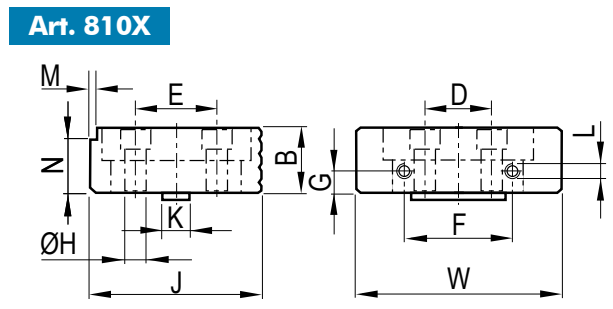
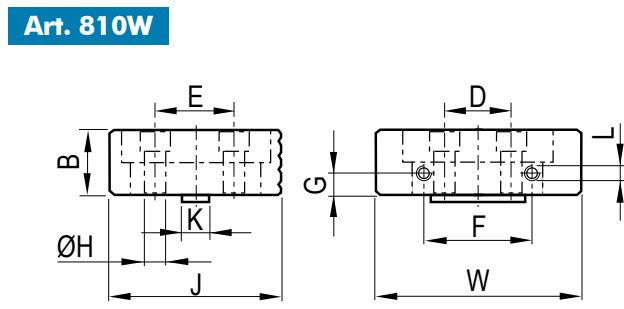

Tipo (grandezza) morsa / Vise (type) size

mm	1	2	3	4	5	6	Tolleranze / Tolerance
B	25	30	40	50	60		- 0,02
D	20	25	38	48	44	54	-
E	32	40	50	60	68	68	-
F	40	50		65		100	-
G		10		20		25	-
H	9	11	13		17	22	-
L	M5			M6			-
K				16			H7
M				5			± 0,01
N				3			± 0,02
J	72	84	106	128	135	143	- 0,02
W	74	94	124	144	169	189	-

Tipo (grandezza) morsa / Vise type (size)	1	2			3	
kN	25 kN	25 kN			30 kN	

Art. 867

Morsa FMS doppia, singola, autocentrante con ganasce oscillanti con inserti regolabili

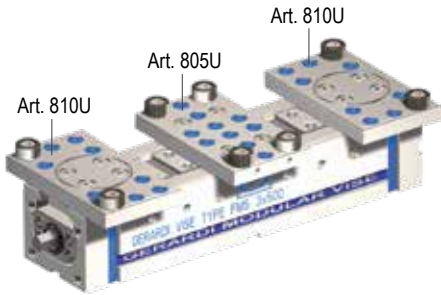

Double, single, self-centering FMS vise with floating jaws with adjustable inserts

A1	91	91	141	191	241	141	191
B	20	20			20		
C	70	90			100		
D	332	300	400	500	600	400	500
E	349	320	420	520	620	425	525
G	75	95			125		
J1	50	50			70		
J2	25	25			35		
Ø	30 (H = 16)	30 (H = 16)			30 (H = 16)		
W	100	120			170		
kg	11	20	27	33	40	40	45

Cod.	5.86.71300	5.86.72300	5.86.72400	5.86.72500	5.86.72600	5.86.73400	5.86.73500
------	------------	------------	------------	------------	------------	------------	------------

Art. 867D

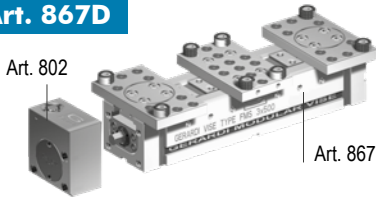

(Art. 867 + 802) Morsa + moltiplicatore di coppia / Vise + torque multiplier

Cod.	5.86.7D130	5.86.7D230	5.86.7D240	5.86.7D250	5.86.7D260	5.86.7D340	5.86.7D350
------	------------	------------	------------	------------	------------	------------	------------

Moltiplicatore di coppia con rinvio angolare - Mechanical with torque multiplier with angular transmission

Cod.	5.80.21000	5.80.22000	5.80.23000
------	------------	------------	------------

Art. 802



Art. 867E

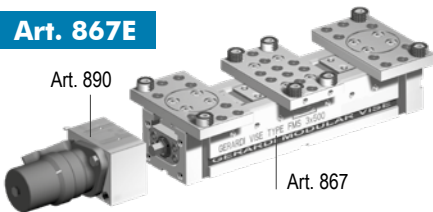

(Art. 867 + 890) Morsa + motore idraulico / Vise + hydraulic motor

Cod.	5.86.7E130	5.86.7E230	5.86.7E240	5.86.7E250	5.86.7E260	5.86.7E340	5.86.7E350
------	------------	------------	------------	------------	------------	------------	------------

Art. 867F

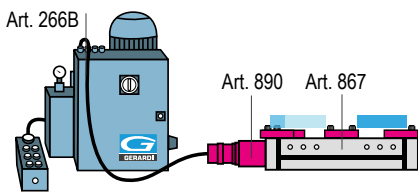

(Art. 867 + 890 + 266B) Morsa + motore idraulico + centralina / Vise + hydraulic motor + power unit

Cod.	5.86.7F130	5.86.7F230	5.86.7F240	5.86.7F250	5.86.7F260	5.86.7F340	5.86.7F350
------	------------	------------	------------	------------	------------	------------	------------

Dotazione standard:

- 2 arresti laterali Art. 370
- 1 coppia di tasselli di posizionamento per cava da 16 mm Art. 297
- 1 chiave a pipa Art. 375
- 1 piastrina di collegamento Art.801S

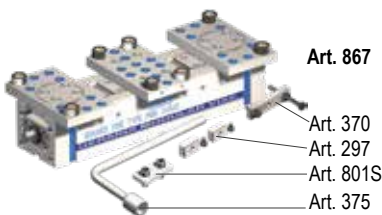

Standard equipment:

- 2 workstops Art. 370
- 1 pair of positioning key-nuts for 16 mm slot Art. 297
- 1 box wrench Art. 375
- 1 connecting plate Art.801S

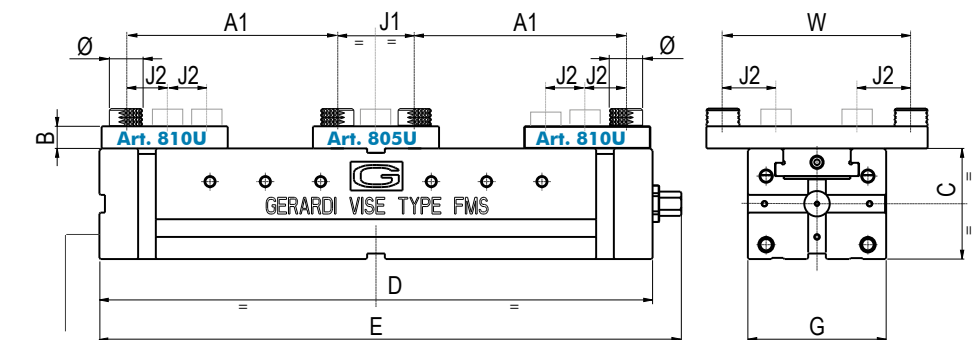

Art. 855
Corpo base / Base body

	3 30 kN			4 30 kN				5 32 kN			6 32 kN		
A1	241	291	341	191	241	291	341	231	281	331	331	381	431
B	20			30				35			35		
C	100			120				140			160		
D	600	700	800	500	600	700	800	600	700	800	800	900	1000
E	625	725	825	525	625	725	825	625	725	825	825	925	1025
G	125			145				170			190		
J1	70			80				100			100		
J2	35			40				40			40		
Ø	30 (H = 16)			30 (H = 16)				40 (H = 30)			40 (H = 30)		
W	170			220				250			300		
kg	50	55	60	68	76	85	93	124	134	144	200	220	240

Cod. 5.86.73600 5.86.73700 5.86.73800 5.86.74500 5.86.74600 5.86.74700 5.86.74800 5.86.75600 5.86.75700 5.86.75800 5.86.76800 5.86.76900 5.86.76100

Art. 867D (Art. 867 + 802) Morsa + moltiplicatore di coppia / Vise + torque multiplier

Cod. 5.86.7D360 5.86.7D370 5.86.7D380 5.86.7D450 5.86.7D460 5.86.7D470 5.86.7D480 5.86.7D560 5.86.7D570 5.86.7D580 5.86.7D680 5.86.7D690 5.86.7D610

Art. 802 Moltiplicatore di coppia con rinvio angolare - Mechanical with torque multiplier with angular transmission

Cod. 5.80.23000 5.80.24000 5.80.25000 5.80.26000

Art. 867E (Art. 867 + 890) Morsa + motore idraulico / Vise + hydraulic motor

Cod. 5.86.7E360 5.86.7E370 5.86.7E380 5.86.7E450 5.86.7E460 5.86.7E470 5.86.7E480 5.86.7E560 5.86.7E570 5.86.7E580 5.86.7E680 5.86.7E690 5.86.7E610

Art. 867F (Art. 867 + 890 + 266B) Morsa + motore idraulico + centralina / Vise + hydraulic motor + power unit

Cod. 5.86.7F360 5.86.7F370 5.86.7F380 5.86.7F450 5.86.7F460 5.86.7F470 5.86.7F480 5.86.7F560 5.86.7F570 5.86.7F580 5.86.7F680 5.86.7F690 5.86.7F610

Art. 867 Esempi applicativi ganasce oscillanti regolabili: Floating adjustable jaws application examples:

Inserti regolabili - adjustable jaw inserts

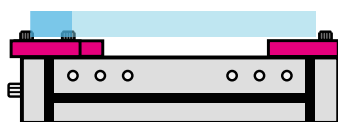

4 inserti - 4 jaw inserts

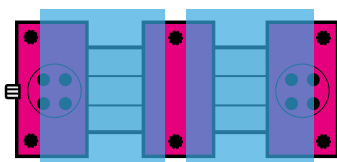
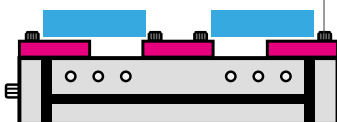

6 inserti - 6 jaw inserts

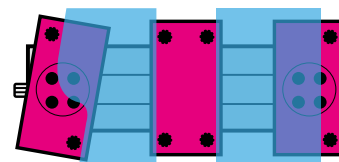
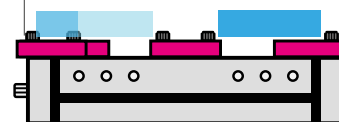

8 inserti - 8 jaw inserts

FUNZIONAMENTO DELLE GANASCE MOBILI OSCILLANTI CON INSERTI

HOW TO OPERATE FLOATING MOVABLE JAWS WITH INSERTS

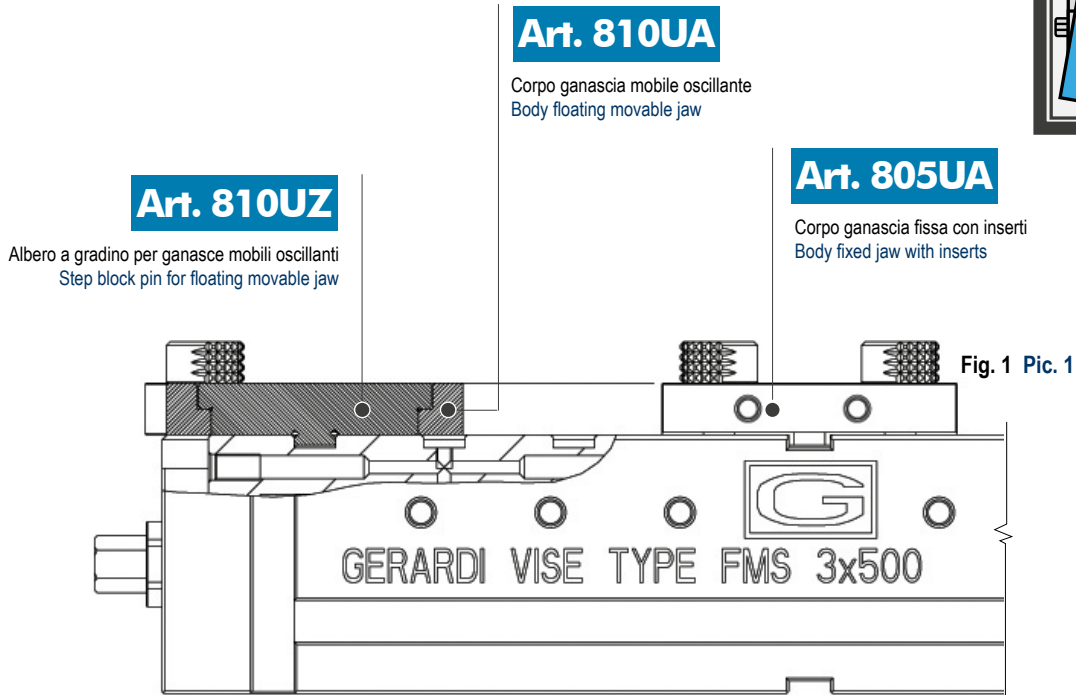
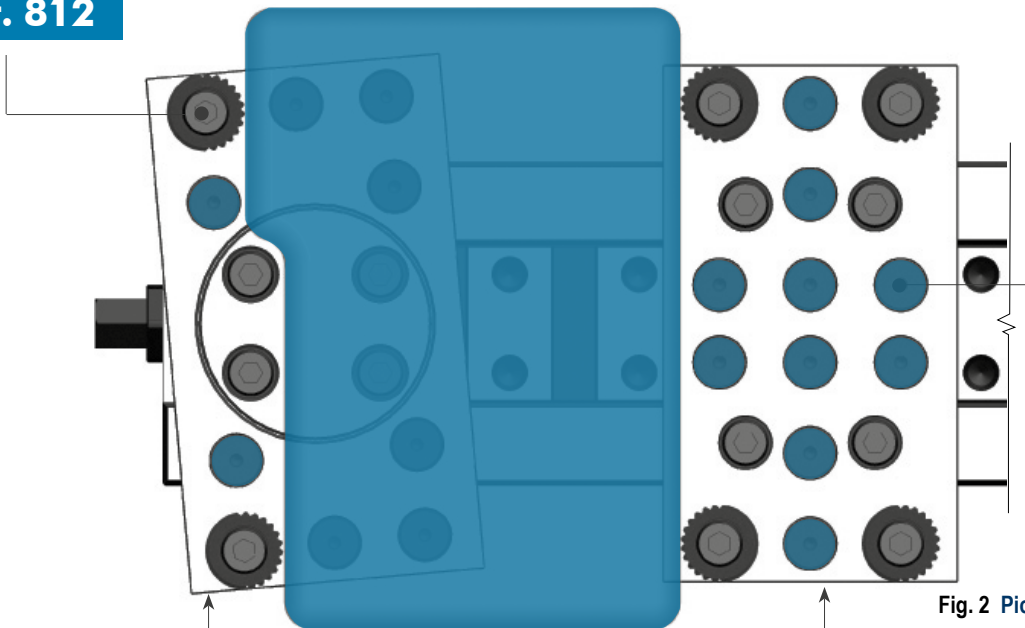
Art. 812

Art. 84U

 Tappo in alluminio (EXTRA)
 Aluminum cap (ETRA)

Art. 810U

 Ganasca mobile oscillante con inserti
 Floating movable jaw with inserts

Art. 805U

 Ganasca fissa con inserti
 Fixed jaw with inserts

Le ganasce mobili oscillanti consentono il serraggio di pezzi di forma irregolare i cui lati non risultino paralleli (Fig. 2). Questo è reso possibile dall'albero a gradino (Art. 810UZ - Fig. 1), posto al centro della ganasca, che pur permettendo la rotazione della ganasca, ne mantiene la precisione ed evita il sollevamento del pezzo mentre viene lavorato. Il tutto a garanzia di un serraggio in piena sicurezza. Gli inserti estremizzano ulteriormente la versatilità delle ganasce mobili oscillanti della morsa FMS.

Floating movable jaws allow to clamp workpieces with irregular shapes whose sides are not parallels (Pic. 2). In fact thanks to the step block spindle (Art. 810UZ - Pic. 1), positioned in the centre of the jaw body, the jaw can float and guarantee at the same time maximum precision and no tilting of the parts while being worked. The safety of the workholding is guaranteed. The insert further increase the versatility of the FMS floating movable jaws.

GANASCE FISSE & MOBILI FMS

FMS FIXED AND MOVABLE JAWS

Tipo (grandezza) / Type (size)	1	2	3	4	5	6
Art. 810U* Ganascia mobile regolabile oscillante con inserti Floating movable jaw with inserts						
	Cod. 5.81.0U100	5.81.0U200	5.81.0U300	5.81.0U400	5.81.0U500	5.81.0U600
	* Set viti per fissaggio a richiesta - Set of fixing screws on request					
Art. 810UA Corpo ganascia mobile oscillante Body floating movable jaw						
	Cod. 5.81.0UA10	5.81.0UA20	5.81.0UA30	5.81.0UA40	5.81.0UA50	5.81.0UA60
Art. 810UZ* Albero a gradino per ganasce mobili oscillanti Step block pin for floating movable jaw						
	Cod. 5.81.0UZ10	5.81.0UZ20	5.81.0UZ30	5.81.0UZ40	5.81.0UZ50	5.81.0UZ60
	* Set viti per fissaggio a richiesta - Set of fixing screws on request					
Art. 810Q* Ganascia mobile regolabile con inserti Movable jaw with inserts						
	Cod. 5.81.0Q100	5.81.0Q200	5.81.0Q300	5.81.0Q400	5.81.0Q500	5.81.0Q600
	* Set viti per fissaggio a richiesta - Set of fixing screws on request					
Art. 810QA Corpo ganascia regolabile mobile per inserti Body movable jaw for inserts						
	Cod. 5.81.0QA10	5.81.0QA20	5.81.0QA03	5.81.0QA40	5.81.0QA50	5.81.0QA60
Art. 805U* Ganascia fissa regolabile con inserti Fixed jaw with inserts						
	Cod. 5.80.5U100	5.80.5U200	5.80.5U300	5.80.5U400	5.80.5U500	5.80.5U600
	* Set viti per fissaggio a richiesta - Set of fixing screws on request					
Art. 805UA Corpo ganascia fissa regolabile per inserti Body fixed jaw per inserts						
	Cod. 5.80.5UA10	5.80.5UA20	5.80.5UA30	5.80.5UA40	5.80.5UA50	5.80.5UA60
Art. 812 Inserto liscio e zigrinato Smooth and serrated insert						
	Ø	30			40	
	H	16			30	
	Cod.	5.81.21000			5.81.25000	
Art. 812A Inserto liscio Smooth insert						
	Cod.	5.81.2A100			5.81.2A500	
Art. 812C Inserto zigrinato Serrated insert						
	Cod.	5.81.2C100			5.81.2C500	
Art. 813 Inserto liscio e zigrinato alto Smooth and serrated high insert						
	Ø	30			40	
	H	28			50	
Art. 813A Inserto liscio alto Smooth high insert						
	Cod.	5.81.31000			5.81.35000	
Art. 813C Inserto zigrinato alto Serrated high insert						
	Cod.	5.81.3C100			5.81.3C500	
Art. 815 Inserto liscio e zigrinato a gradino Pair of smooth and serrated step insert						
	H	16			30	
Art. 815A Inserto liscio a gradino Smooth step insert						
	Cod.	5.81.51000			5.81.55000	
Art. 815C Inserto zigrinato a gradino Serrated step insert						
	Cod.	5.81.5A100			5.81.5A500	
	Cod.	5.81.5C100			5.81.5C500	
Art. 812B Inserto in acciaio lavorabile Insert in machineable steel metal						
	Ø	40			60	
	H	40			60	
	Cod.	5.81.2B100			5.81.2B500	
Art. 84U Tappo in alluminio (EXTRA) Aluminum cap (ETRA)						
	Cod.	5.84.U1000			5.84.U5000	

Tipo (grandezza) morsa / Vise type (size)

kN	1		2				3	
	25 kN		25 kN				30 kN	
A	130	230	182	282	382	482	244	344
B	99,5			117			137	
C	70			90			100	
D	232	332	300	400	500	600	400	500
E	249	349	320	420	520	620	425	525
F	169,5			207			237	
G	75			95			125	
H	75			85			98	
L	56			64			84	
J3	76	76		101			132	
J4	55	55		63			82	
X	39,5			47			57	
W	74			94			124	
kg	-			-			-	

Art. 868

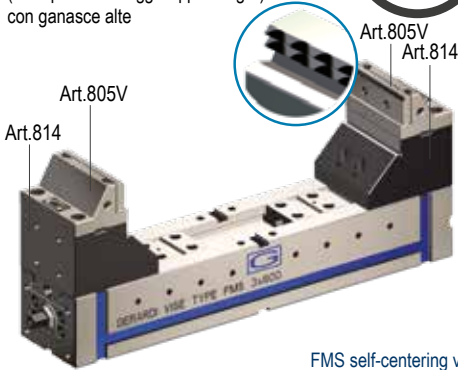
 Morsa FMS autocentrante
 (con opzione serraggi doppi o singoli)
 con ganasce alte

 FMS self-centering vise
 (with double or single
 clamping option) with high jaws

Cod.	5.86.81200	5.86.81300	5.86.82300	5.86.82400	5.86.82500	5.86.82600	5.86.83400	5.86.83500
------	------------	------------	------------	------------	------------	------------	------------	------------

Art. 868D



(Art. 868 + 802) Morsa + moltiplicatore di coppia / Vise + torque multiplier

Cod.	5.86.8D120	5.86.8D130	5.86.8D230	5.86.8D240	5.86.8D250	5.86.8D260	5.86.8D340	5.86.8D350
------	------------	------------	------------	------------	------------	------------	------------	------------

Moltiplicatore di coppia con rinvio angolare - Mechanical with torque multiplier with angular transmission

Cod.	5.80.21000	5.80.22000	5.80.23000
------	------------	------------	------------

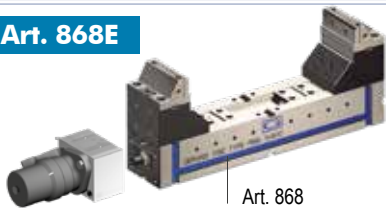
Art. 802

Art. 868E

(Art. 868 + 890) Morsa + motore idraulico / Vise + hydraulic motor

Cod.	5.86.8E120	5.86.8E130	5.86.8E230	5.86.8E240	5.86.8E250	5.86.8E260	5.86.8E340	5.86.8E350
------	------------	------------	------------	------------	------------	------------	------------	------------

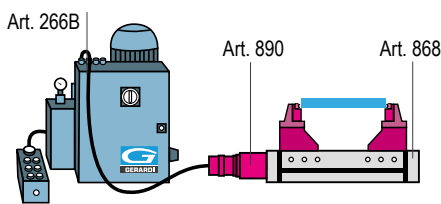
Art. 868F

(Art. 868 + 890 + 266B) Morsa + motore idraulico + centralina / Vise + hydraulic motor + power unit

Cod.	5.86.8F120	5.86.8F130	5.86.8F230	5.86.8F240	5.86.8F250	5.86.8F260	5.86.8F340	5.86.8F350
------	------------	------------	------------	------------	------------	------------	------------	------------

Dotazione standard:

- 2 arresti laterali Art. 370
- 1 coppia di tasselli di posizionamento per cava da 16 mm Art. 297
- 1 chiave a pipa Art. 375
- 1 piastrina di collegamento Art.801S

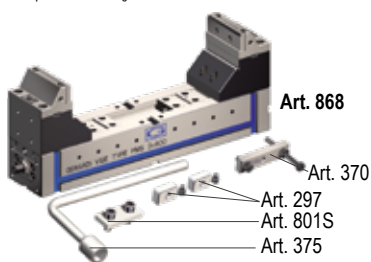

Standard equipment:

- 2 workstops Art. 370
- 1 pair of positioning key-nuts for 16 mm slot Art. 297
- 1 box wrench Art. 375
- 1 connecting plate Art.801S

Art. 855

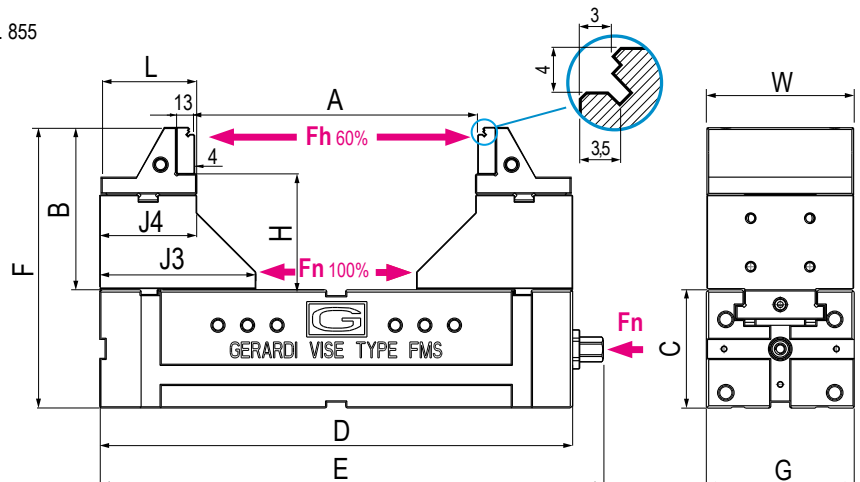

	3 30 kN			4 30 kN				5 32 kN			6 32 kN		
A	444	544	644	316	416	516	616	396	496	596	596	696	796
B		137				171			186			246	
C		100				120			140			160	
D	600	700	800	500	600	700	800	600	700	800	800	900	1000
E	625	725	825	525	625	725	825	625	725	825	825	925	1025
F		237				291			326			406	
G		125				145			170			190	
H		98				128			138			180	
L		84				97			107			107	
J3		132				154			169			189	
J4		82				96			106			106	
X		57				64			66			86	
W		124				144			169			189	
kg	-					-			-			-	

Cod. 5.86.83600 5.86.83700 5.86.83800 5.86.84500 5.86.84600 5.86.84700 5.86.84800 5.86.85600 5.86.85700 5.86.85800 5.86.86800 5.86.86900 5.86.86100

Art. 868D

(Art. 868 + 802) Morsa + moltiplicatore di coppia / Vise + torque multiplier

Cod. 5.86.8D360 5.86.8D370 5.86.8D380 5.86.8D450 5.86.8D460 5.86.8D470 5.86.8D480 5.86.8D560 5.86.8D570 5.86.8D580 5.86.8D680 5.86.8D690 5.86.8D610

Art. 802

Moltiplicatore di coppia con rinvio angolare - Mechanical with torque multiplier with angular transmission

Cod. 5.80.23000 5.80.24000 5.80.25000 5.80.26000

Art. 868E

(Art. 868 + 890) Morsa + motore idraulico / Vise + hydraulic motor

Cod. 5.86.8E360 5.86.8E370 5.86.8E380 5.86.8E450 5.86.8E460 5.86.8E470 5.86.8E480 5.86.8E560 5.86.8E570 5.86.8E580 5.86.8E680 5.86.8E690 5.86.8E610

Art. 868F

(Art. 868 + 890 + 266B) Morsa + motore idraulico + centralina / Vise + hydraulic motor + power unit

Cod. 5.86.8F360 5.86.8F370 5.86.8F380 5.86.8F450 5.86.8F460 5.86.8F470 5.86.8F480 5.86.8F560 5.86.8F570 5.86.8F580 5.86.8F680 5.86.8F690 5.86.8F610

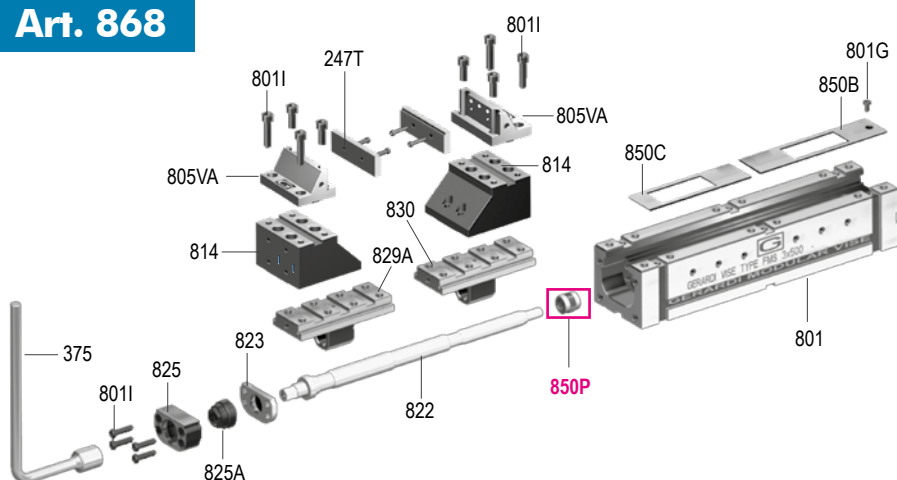
Art. 868

Art.	Pag.	Art.	Pag.
375	4.35	850B	5.61
801	5.50	850C	5.61
801G	5.61	850P	5.72
801I	5.61	814	5.56
810J	5.56	805VA	5.35
822	5.53	247T	5.35
823	5.59	-	-
825	5.59	-	-
825A	5.61	-	-
829A	5.52	-	-
830	5.52	-	-

POSSIBILI COMBINAZIONI DELLA MORSA Art.868

POSSIBLE ARRANGEMENTS OF THE Art.868 VISE

Orientamento base mobile Art.814 per massima apertura ganasce
Movable base Art.814 oriented for the maximum jaws opening

Orientamento base mobile Art.814 per chiusura ganasce a zero
Movable base Art.814 oriented in order to close jaws completely

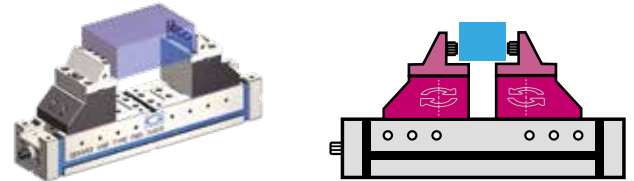
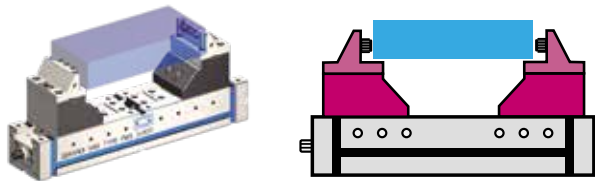
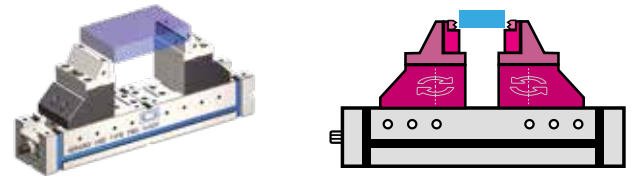
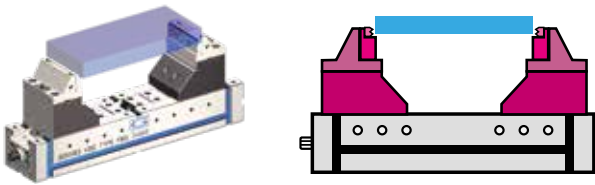
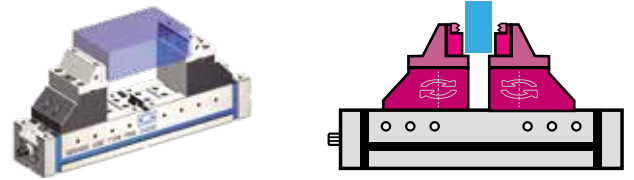
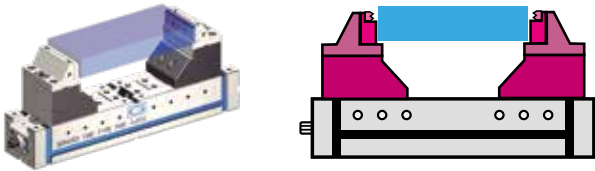

Art. 868

1 Art.90
PUNTALE TEMPRATO GRIP
HARDENED GRIP POINT

2 Art.247T
PIASTRINA PIANA GRIP
STRAIGHT JAW PLATE GRIP

3 Art.805VA
CORPO GANASCIA
JAW PLATE BODY

4 Art.814
BASE PER GANASCE FISSE
BASE FOR FIXED JAWS

5 Art.855
CORPO BASE CUBO
CUBE BASE BODY

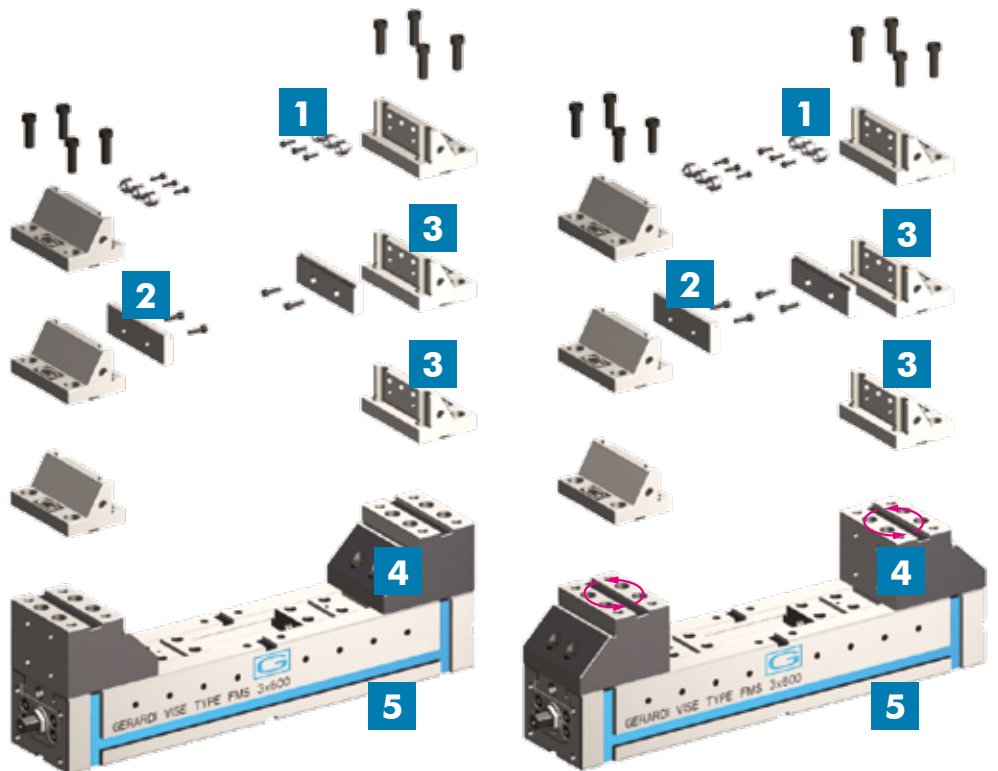

Possibilità di utilizzo di qualsiasi ganascia fissa FMS anziché del corpo ganascia 805V. Possibilità di due posizioni per ciascuna ganascia fissa e per base ganascia mobile Art.814
Possibility to use each FMS fixed jaw instead of jaw body Art.805V. Possibility of two positions (at 180°) for each fixed jaw and for movable base jaw Art.814

GANASCE & PIASTRE GANASCE PER Art.868

JAWS & JAW PLATES FOR Art.868

Tipo (grandezza) / Type (size)

1

2

3

4

5

6

Art. 805V*

Ganascia per piastrine e puntali
Jaw for plates and points



Cod. 5.80.5V100 5.80.5V200 5.80.5V300 5.80.5V400 5.80.5V500 5.80.5V600

* Viti per fissaggio a richiesta Fixing screws on request

Art. 90

Puntale temprato GRIP
Hardened GRIP Insert



Cod. 5.90.10000

Art. 247T (W2)

Piastra piana temprata GRIP
con larghezza ridotta
Hardened straight jaw plate GRIP
with narrow width



Cod. 4.24.7T100 4.24.7T200 4.24.7T300 4.24.7T400 4.24.7T500 4.24.7T600

Per qualsiasi piastra piana speciale, raddoppiare il prezzo
For special I taylor made straight jaw plate double the price

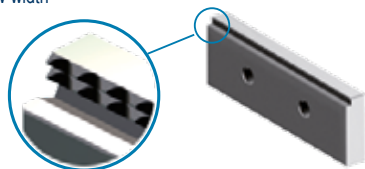

PIASTRE GANASCE "GRIP" JAW PLATES

MINOR SUPERFICIE DI CONTATTO + PRESSIONE DI SERRAGGIO

LESS SURFACE CONTACT + CLAMPING PRESSURE

Art. 805VA

Corpo Ganascia
Jaw for plates and points

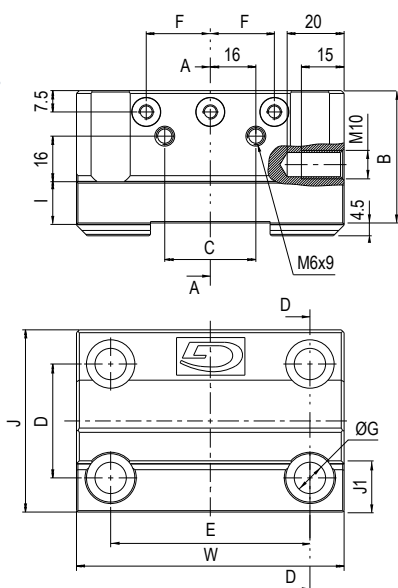

Art. 247T

Piastrina piana temprata GRIP
Hardened straight jaw plate GRIP

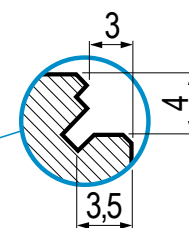
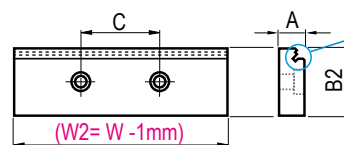

Art. 90

Puntale temprato GRIP
Hardened GRIP Point

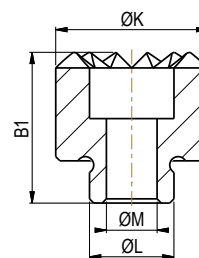

mm	1	2	3	4	5	6
W	74	94	124	144	169	189
A	12	12	13	13	18	
B	39,5	47	57	61	66	86
B2	24,5	32	39	43	48	56
C	25	32	50	50	76	90
D	32	40	50	60	68	68
E	56	70	92	108	126	144
F	2X26	3x20	3x25	4x20	4x25	4x30
ØG	9	11	13	17	17	21
I	15	15	18	18	18	20
J	56	64	84	97	107	107
J1				17		
ØK	-			18		-
ØL	-			10 h8		-
ØM	-			6		-

Tipo (grandezza) morsa / Vise type (size)	kN	1		2				3	
		25 kN		25 kN				30 kN	
Apertura minima - massima / minimum - maximum Aperture	A	10 / 25	10 / 25	20 / 50	20 / 50	20 / 50	20 / 50	40 / 100	40 / 100
Apertura minima - massima / minimum - maximum Aperture	A1	10 / 15	10 / 15	10 / 25	10 / 25	10 / 25	10 / 25	25 / 50	25 / 50
	B	34		55				90	
	C	70		90				100	
	D	232	332	300	400	500	600	400	500
	E	249	349	320	420	520	620	425	525
	F	104		145				190	
	G	75		95				125	
	J	48	60	102				132	
	W	50		75				100	
	kg	9	12	23	30	63	43	47	52
	Cod.	5.87.01200	5.87.01300	5.87.02300	5.87.02400	5.87.02500	5.87.02600	5.87.03400	5.87.03500

Art. 870

Morsa FMS autocentrante (opzione doppia o singola) con ganasce primatiche



FMS self-centering vise (double or single option) with prismatic jaws

Art. 870D

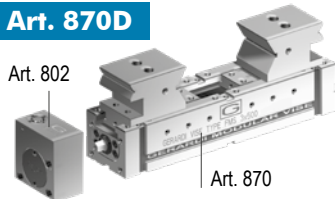

Art. 802

Art. 870

(Art. 870 + 802) Morsa + moltiplicatore di coppia / Vise + torque multiplier

Cod. 5.87.0D120 5.87.0D130 5.87.0D230 5.87.0D240 5.87.0D250 5.87.0D260 5.87.0D340 5.87.0D350

Moltiplicatore di coppia con rinvio angolare - Mechanical with torque multiplier with angular transmission

Cod. 5.80.21000 5.80.22000 5.80.23000

Art. 802



Art. 870E

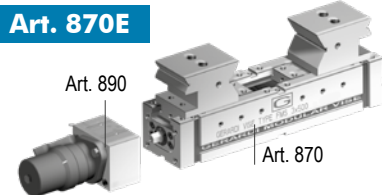

Art. 890

Art. 870

(Art. 870 + 890) Morsa + motore idraulico / Vise + hydraulic motor

Cod. 5.87.0E120 5.87.0E130 5.87.0E230 5.87.0E240 5.87.0E250 5.87.0E260 5.87.0E340 5.87.0E350

Art. 870F

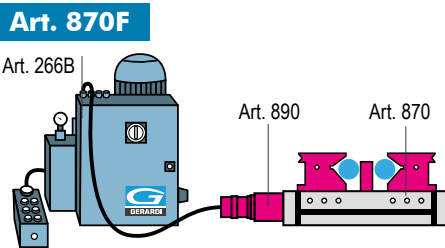

Art. 266B

Art. 890

Art. 870

(Art. 870 + 890 + 266B) Morsa + motore idraulico + centralina / Vise + hydraulic motor + power unit

Cod. 5.87.0F120 5.87.0F130 5.87.0F230 5.87.0F240 5.87.0F250 5.87.0F260 5.87.0F340 5.87.0F350

Dotazione standard:

- 2 arresti laterali Art. 370
- 1 coppia di tasselli di posizionamento per cava da 16 mm Art. 297
- 1 chiave a pipa Art. 375
- 1 piastrina di collegamento Art.801S

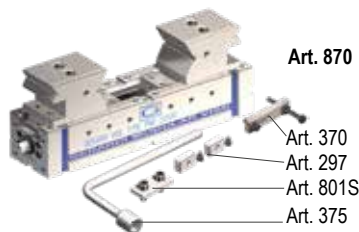

Art. 870

Art. 370

Art. 297

Art. 801S

Art. 375

Standard equipment:

- 2 workstops Art. 370
- 1 pair of positioning key-nuts for 16 mm slot Art. 297
- 1 box wrench Art. 375
- 1 connecting plate Art.801S

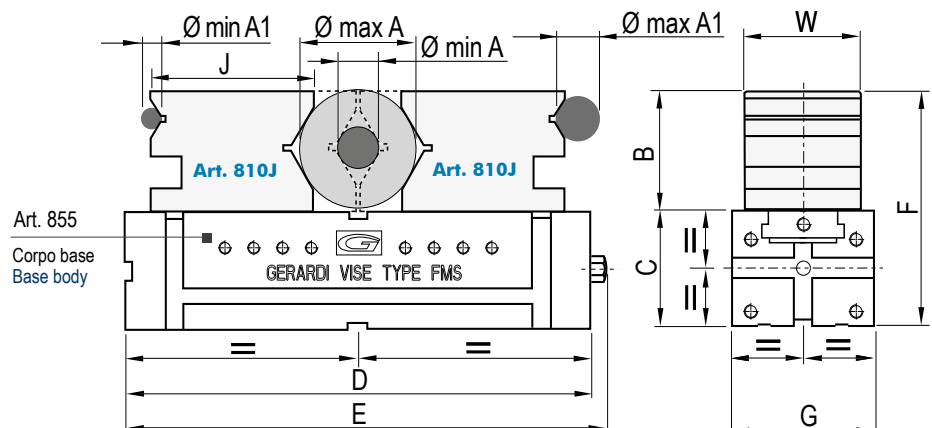

	3 30 kN			4 30 kN				5 32 kN			6 32 kN		
A	40 / 100	40 / 100	40 / 100	40 / 150	40 / 150	40 / 150	40 / 150	63 / 200	65 / 240	80 / 280	100 / 300	120 / 350	140 / 400
A1	25 / 50	25 / 50	25 / 50	30 / 60	30 / 60	30 / 60	30 / 60	35 / 70	35 / 70	35 / 80	40 / 140	40 / 140	40 / 140
B	90			132				171	191	226	250	275	300
C	100			120				140			160		
D	600	700	800	500	600	700	800	600	700	800	800	900	1000
E	625	725	825	525	625	725	825	625	725	825	825	925	1025
F	190			252				311	331	366	410	435	460
G	125			145				170			190		
J	132			156				176			174		
W	100			132				140			160		
kg	57	62	67	74	82	91	99	135	145	155	225	245	265

Cod. 5.87.03600 5.87.03700 5.87.03800 5.87.04500 5.87.04600 5.87.04700 5.87.04800 5.87.05600 5.87.05700 5.87.05800 5.87.06800 5.87.06900 5.87.06100

Art. 870D (Art. 870 + 802) Morsa + moltiplicatore di coppia / Vise + torque multiplier

Cod. 5.87.0D360 5.87.0D370 5.87.0D380 5.87.0D450 5.87.0D460 5.87.0D470 5.87.0D480 5.87.0D560 5.87.0D570 5.87.0D580 5.87.0D680 5.87.0D690 5.87.0D610

Art. 802 Moltiplicatore di coppia con rinvio angolare - Mechanical with torque multiplier with angular transmission

Cod. 5.80.23000 5.80.24000 5.80.25000 5.80.26000

Art. 870E (Art. 870 + 890) Morsa + motore idraulico / Vise + hydraulic motor

Cod. 5.87.0E360 5.87.0E370 5.87.0E380 5.87.0E450 5.87.0E460 5.87.0E470 5.87.0E480 5.87.0E560 5.87.0E570 5.87.0E580 5.87.0E680 5.87.0E690 5.87.0E610

Art. 870F (Art. 870 + 890 + 266B) Morsa + motore idraulico + centralina / Vise + hydraulic motor + power unit

Cod. 5.87.0F360 5.87.0F370 5.87.0F380 5.87.0F450 5.87.0F460 5.87.0F470 5.87.0F480 5.87.0F560 5.87.0F570 5.87.0F580 5.87.0F680 5.87.0F690 5.87.0F610

Art. 870 Esempi applicativi ganasce prismatiche:
 Prismatic jaws application examples:

Ganasce ruotate di 180° - Jaws rotated 180°

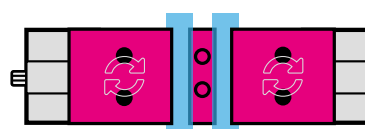
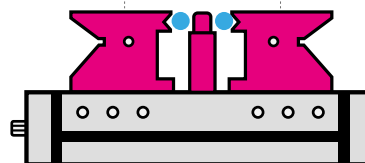
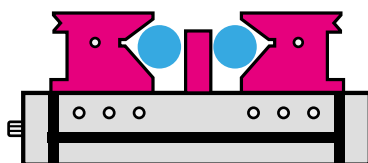
Art. 870A

Pag.5.54 Page. 5.54

Per il serraggio di 2 particolari tondi contemporaneamente per mezzo della ganasce intermedia alta Art.870A
 For clamping 2 round workpieces simultaneously by intermediate high jaw Art.870A

N.B. Realizzabili versioni speciali per diametro **Max.1500** - Special Types available on request for **up to Ø1500**

Tipo (grandezza) morsa / Vise type (size)	kN	1 25 kN		2 25 kN			3 30 kN		
Apertura massima / Maximum opening	A	85	185	170	270	370	470	230	330
Minima apertura interno-esterno / Minimum opening inside-outside	A1	115 / 200	115 / 300	130 / 300	130 / 400	130 / 500	130 / 600	170 / 400	170 / 500
	B	25		30			40		
	C	70		90			100		
	D	232	332	300	400	500	600	400	500
	E	249	349	320	420	520	620	425	525
	G	75		95			125		
	W	74		94			124		
	kg	7	10	18	25	32	39	40	45

Art. 800

Morsa a Serraggio Meccanico solo per serraggi singoli

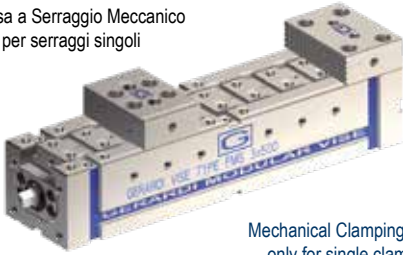

Mechanical Clamping vise only for single clamping

Cod. 5.80.01200 5.80.01300 5.80.02300 5.80.02400 5.80.02500 5.80.02600 5.80.03400 5.80.03500

SPECIFICA SOLO PER SERRAGGI SINGOLI

SPECIFIC FOR SINGLE CLAMPING ONLY

Questa morsa, pur essendo parte del programma FMS, non è predisposta per serraggi doppi o autocentranti

Art. 800A

Meccanica con predisposizione idraulica solo per serraggi singoli / Mechanical with prepared hydraulic connection only for single clamping

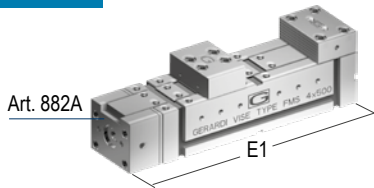

Art. 882A

E1

E1	273	373	370,5	470,5	570,5	670,5	485	585
Cod.	5.80.0A120	5.80.0A130	5.80.0A230	5.80.0A240	5.80.0A250	5.80.0A260	5.80.0A340	5.80.0A350

Connettore Idraulico - Hydraulic Connexion

Corsa - Stroke mm	4	7	10
Superficie - Surface cm ²	6	21	21
Pressione - Pressure bar	417	119	143

Art. 882A

Art. 800B

(Art. 800A + Art.393) Morsa + centralina a comando manuale singolo / Vise + power unit with single manual control

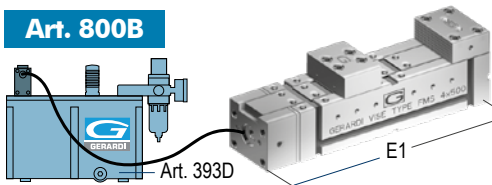

Art. 393D

E1

E1	273	373	370,5	470,5	570,5	670,5	485	585
Cod.	5.80.0B120	5.80.0B130	5.80.0B230	5.80.0B240	5.80.0B250	5.80.0B260	5.80.0B340	5.80.0B350

Art. 800D

(Art. 800 + 802) Morsa + moltiplicatore di coppia / Vise + torque multiplier

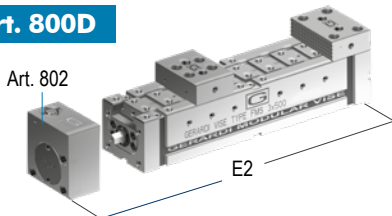

Art. 802

E2

E2	277	377	360	460	560	660	470	570
Nm	Max 20		Max 25			Max 20		
Cod.	5.80.0D120	5.80.0D130	5.80.0D230	5.80.0D240	5.80.0D250	5.80.0D260	5.80.0D340	5.80.0D350

Moltiplicatore di coppia con rinvio angolare - Mechanical with torque multiplier with angular transmission

Cod.	5.80.21000	5.80.22000	5.80.23000
------	------------	------------	------------

Dotazione standard:

- 2 arresti laterali Art. 370
- 1 coppia di tasselli di posizionamento per cava da 16 mm Art. 297
- 1 chiave a pipa Art. 375

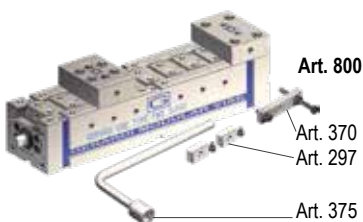

Standard equipment:

- 2 workstops Art. 370
- 1 pair of positioning key-nuts for 16 mm slot Art. 297
- 1 box wrench Art. 375

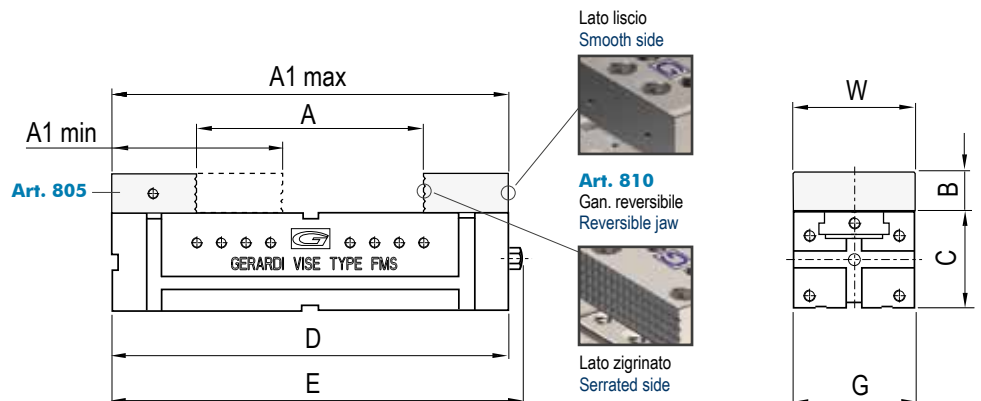

	3 30 kN			4 30 kN				5 32 kN			6 32 kN		
A	430	530	630	300	400	500	600	380	480	580	580	680	780
A1	170 / 600	170 / 700	170 / 800	200 / 500	200 / 600	200 / 700	200 / 800	220 / 600	220 / 700	220 / 800	220 / 800	220 / 800	220 / 100
B	40			50				60			60		
C	100			120				140			160		
D	600	700	800	500	600	700	800	600	700	800	800	900	1000
E	625	725	825	525	625	725	825	625	725	825	825	925	1025
G	125			145				170			190		
W	124			144				169			189		
kg	50	55	60	66	72	80	88	115	125	135	170	190	210

Cod. 5.80.03600 5.80.03700 5.80.03800 5.80.04500 5.80.04600 5.80.04700 5.80.04800 5.80.05600 5.80.05700 5.80.05800 5.80.06800 5.80.06900 5.80.06100

This type of vise even if it is part of the FMS series is not suitable for double or self-centering clamping

Art. 800A

Meccanica con predisposizione idraulica solo per serraggi singoli / Mechanical with prepared hydraulic connection only for single clamping

E1	685	785	885	585	685	785	885	-	-	-	-	-	-
Cod.	5.80.0A360	5.80.0A370	5.80.0A380	5.80.0A450	5.80.0A460	5.80.0A470	5.80.0A480	5.80.0A560	5.80.0A570	5.80.0A580	5.80.0A680	5.80.0A690	5.80.0A610

Art. 882A

Connettore Idraulico - Hydraulic Connexion

	10			10				-			-		
	21			21				-			-		
	143			143				-			-		

Art. 800B

(Art. 800A + Art.393) Morsa + centralina a comando manuale singolo / Vise + power unit with single manual control

E1	685	785	885	585	685	785	885	-	-	-	-	-	-
Cod.	5.80.0B360	5.80.0B370	5.80.0B380	5.80.0B450	5.80.0B460	5.80.0B470	5.80.0B480	5.80.0B560	5.80.0B570	5.80.0B580	5.80.0B680	5.80.0B690	5.80.0B610

Art. 800D

(Art. 800 + 802) Morsa + moltiplicatore di coppia / Vise + torque multiplier

E2	670	770	870	570	670	770	870	685	785	885	-	-	-
Nm	Max 20			Max 20				Max 20			Max 20		
Cod.	5.87.0D360	5.87.0D370	5.87.0D380	5.87.0D450	5.87.0D460	5.87.0D470	5.87.0D480	5.87.0D560	5.87.0D570	5.87.0D580	5.87.0D680	5.87.0D690	5.87.0D610

Art. 802

Moltiplicatore di coppia con rinvio angolare - Mechanical with torque multiplier with angular transmission

Cod.	5.80.23000	5.80.24000	5.80.25000	5.80.26000
------	------------	------------	------------	------------

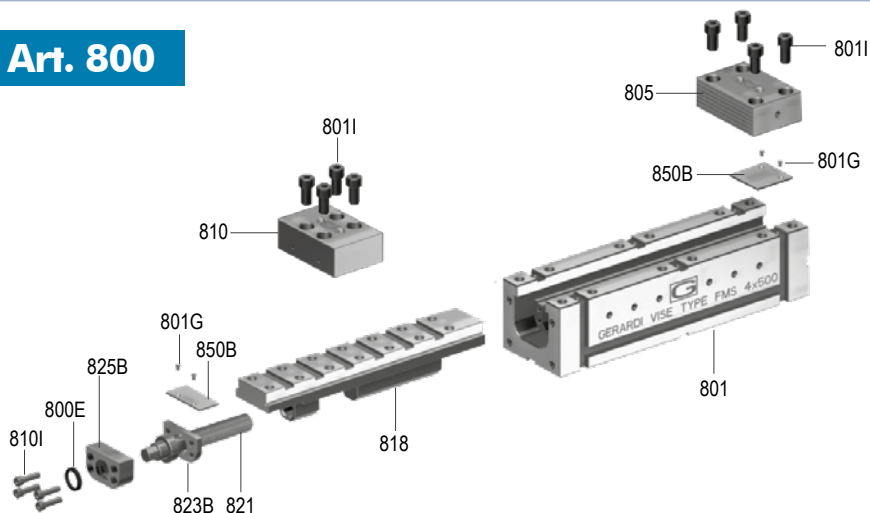
Art. 800

Art.	Pag.	Art.	Pag.
800E	5.61	-	-
801	5.50	-	-
801G	5.61	-	-
801I	5.61	-	-
805	5.54	-	-
810	5.56	-	-
818	5.52	-	-
821	5.53	-	-
823B	5.59	-	-
825B	5.59	-	-
850B	5.61	-	-

Tipo (grandezza) morsa / Vise type (size)	kN	1						2		3	
		30 kN									
Apertura massima / Maximum opening	A	-	-	-	-	-	-	-	232	332	
Art. 900 Morsa a Serraggio Meccanico con Limitatore di Forza solo per serraggi singoli  Mechanical Clamping vise with Limiting Device only for single clamping	B	-	-	-	-	-	-	-	40		
	C	-	-	-	-	-	-	-	100		
	D	-	-	-	-	-	-	-	510	610	
	E	-	-	-	-	-	-	-	400	500	
	G	-	-	-	-	-	-	-	125		
	W	-	-	-	-	-	-	-	124		
	kg	-	-	-	-	-	-	-	-	44	
Cod.	-	-	-	-	-	-	-	5.90.03400	5.90.03500		
		ATTUALMENTE NON DISPONIBILI - CURRENTLY NOT AVAILABLE									

Questa morsa, pur essendo parte del programma FMS, non è predisposta per serraggi doppi o autocentranti

Art. 900Y Modulo per serraggio idraulico Module for hydraulic clamping 	Cod.	-	-	5.90.0Y300
		ATTUALMENTE NON DISPONIBILI - CURRENTLY NOT AVAILABLE		

5

FUNZIONAMENTO LIMITATORE DI FORZA - HOW TO USE THE LIMITING DEVICE

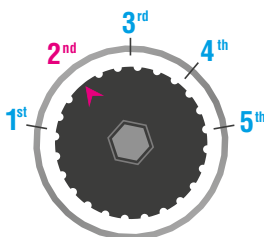

1 Scegliere forza di serraggio tramite ghiera limitatore di forza.
Presetting of the clamping force through the clamping limiter

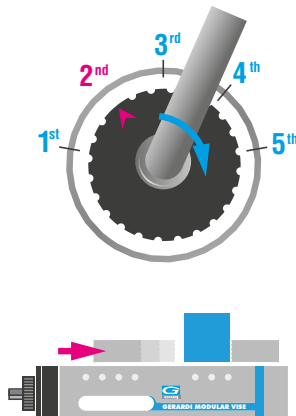

2 Rapido avvicinamento ganascia mobile al pezzo da serrare
Quick approach of the jaw to the workpiece

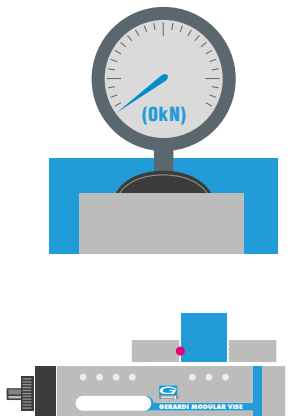

3 Contatto ganascia-particolare e sblocco frizione limitatore di forza.
First contact jaw-workpiece and clamping limiter friction release

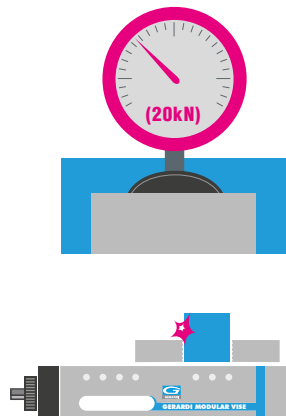

4 Avvio meccanismo moltiplica forza. Fermarsi a fine corsa.
Force multiplier device start. At the end-stroke stop clamping.

Dotazione standard:

- 2 arresti laterali Art. 370
- 1 coppia di tasselli di posizionamento per cava da 16 mm Art. 297
- 1 chiave a pipa Art. 375

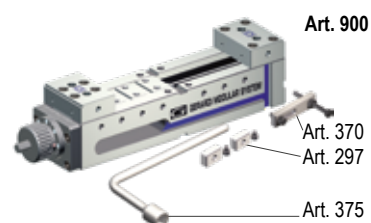

Standard equipment:

- 2 workstops Art. 370
- 1 pair of positioning key-nuts for 16 mm slot Art. 297
- 1 box wrench Art. 375

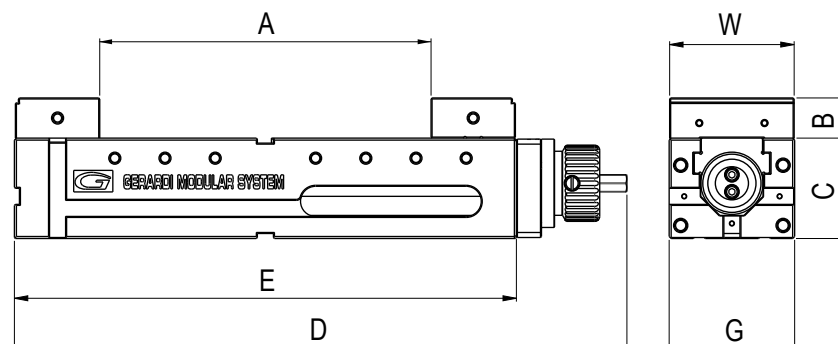

	3 30 kN			4 30 kN				5 32 kN			6		
A	432	532	632	304	404	505	605	384	484	584	-	-	-
B		40			50				60				
C		100			120				140				
D	710	810	910	610	710	810	910	710	810	910	-	-	-
E	600	700	800	500	600	700	800	600	700	800	-	-	-
G		125			145				170				
W		124			144				169				
kg	-	-	-	57	-	-	-	99	-	-	-	-	-
Cod.	5.90.03600	5.90.03700	5.90.03800	5.90.04500	5.90.04600	5.90.04700	5.90.04800	5.90.05600	5.90.05700	5.90.05800	-	-	-
											ATTUALMENTE NON DISPONIBILI CURRENTLY NOT AVAILABLE		

This type of vise even if it is part of the FMS series is not suitable for double or self-centering clamping

Art. 900Y

Cod.	5.90.0Y300	5.90.0Y300	5.90.0Y300	-
				ATTUALMENTE NON DISPONIBILI CURRENTLY NOT AVAILABLE

Diagrammi forze di serraggio - Diagrams with clamping force
Morse tipo
Vises type
3

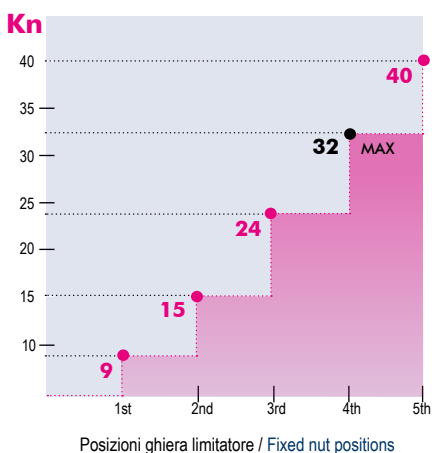
 VITE: Ø 24 mm / Ø 30 mm PASSO: 2 mm
 SCREW: Ø 24 mm / Ø 30 mm PITCH: 2 mm
 Chiave dinamometrica / Torque wrench

Posizioni ghiera limitatore / Fixed nut positions

Morse tipo
Vises type
4

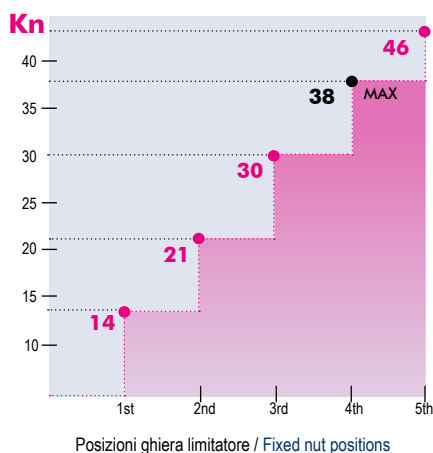
 VITE: Ø 24 mm / Ø 30 mm PASSO: 2 mm
 SCREW: Ø 24 mm / Ø 30 mm PITCH: 2 mm
 Chiave dinamometrica / Torque wrench

Posizioni ghiera limitatore / Fixed nut positions

Morse tipo
Vises type
5

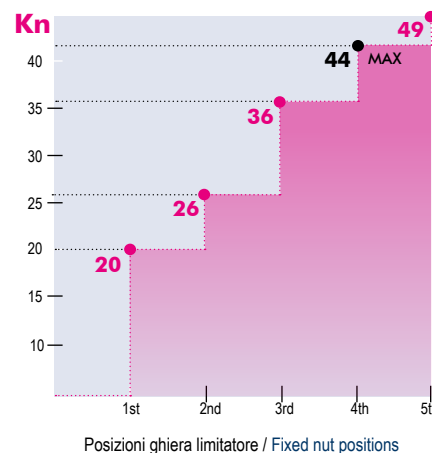
 VITE: Ø 24 mm / Ø 30 mm PASSO: 2 mm
 SCREW: Ø 24 mm / Ø 30 mm PITCH: 2 mm
 Chiave dinamometrica / Torque wrench

Posizioni ghiera limitatore / Fixed nut positions

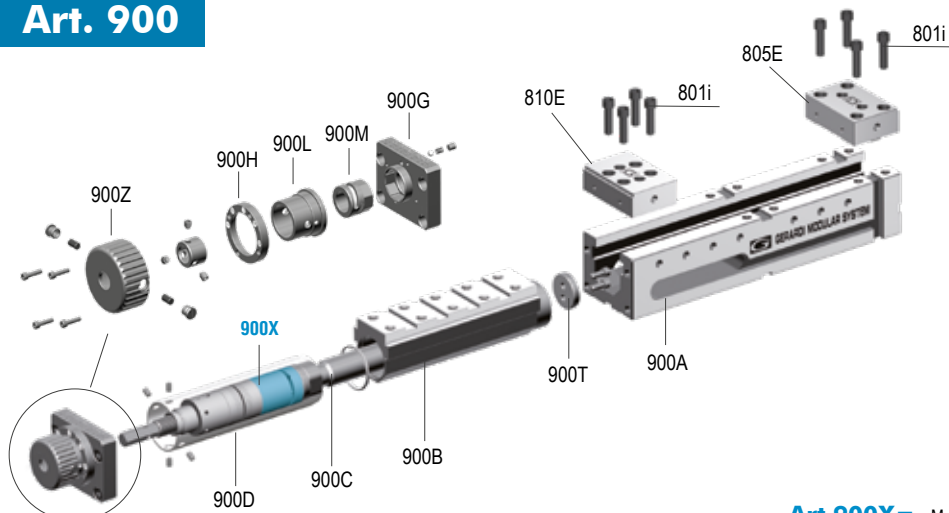
Art. 900

NEW

Art.	Pag.
900Y	40
810E	57
805E	55

Art.900X= Modulo per serraggio meccanico - Module for mechanical clamping

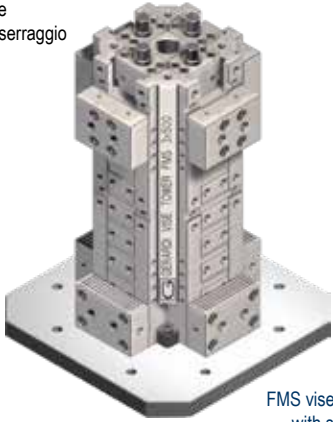
Tipo (grandezza) morsa / Vise type (size)	kN	1		2				3	
		25 kN		25 kN				30 kN	
Apertura massima / Max. opening	A	85	185	170	270	370	470	230	330
Art. 800C	A1	115		130				170	
	B	25		30				40	
	D	200	300	300	400	500	600	400	500
	E	232	332	320	420	520	620	425	525
	G1	120						210	
	L	300		350				400	
	M	33		33				38	
	W	74		94				124	
	kg	30	45	53	70	88	106	90	112



FMS vise tower with straight jaws for 4 clamping stations

SPECIFICA SOLO PER SERRAGGI SINGOLI
 SPECIFIC FOR SINGLE CLAMPING ONLY

Cod.	5.80.0C120	5.80.0C130	5.80.0C230	5.80.0C240	5.80.0C250	5.80.0C260	5.80.0C340	5.80.0C350
------	------------	------------	------------	------------	------------	------------	------------	------------

Questa morsa, pur essendo parte del programma FMS, non è predisposta per serraggi doppi o autocentranti

Art. 800G

NEW 2021

 Modulo base cubo morsa FMS (senza ganasce)
 FMS vise tower base (without jaws)

Cod.	5.80.0G120	5.80.0G130	5.80.0G230	5.80.0G240	5.80.0G250	5.80.0G260	5.80.0G340	5.80.0G350
------	------------	------------	------------	------------	------------	------------	------------	------------

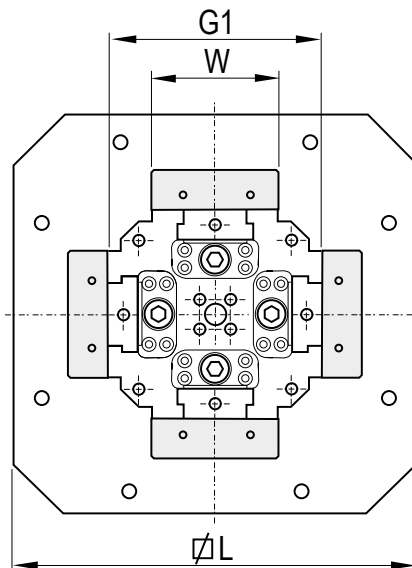
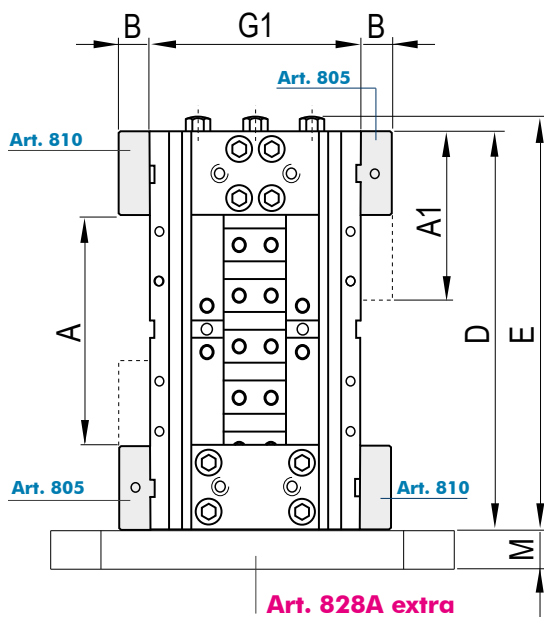
GANASCE REVERSIBILI
REVERSIBLE JAWS

- Dotazione standard per Art. 800C
- 1 chiave a pipa Art. 375
 - 4 arresti laterali Art. 370
 - 2 coppie di tasselli di posizionamento per cava da 16 mm Art. 297
 - 1 golphare di sollevamento Art. 848
 - Imballo in cassa di legno

- Standard equipment for Art. 800C
- 1 box wrench Art. 375
 - 4 workstops Art. 370
 - 2 pair of positioning key-nuts for 16 mm slot Art. 297
 - 1 lifting hook Art. 848
 - Wooden box packaging

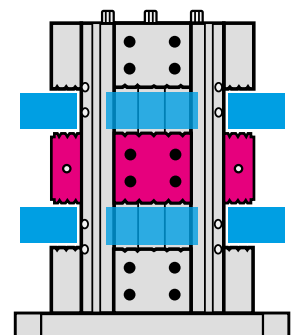

	3 30 kN			4 30 kN				5 32 kN			6 32 kN		
A	430	530	630	300	400	500	600	380	480	580	480	580	680
A1	170			509				630			810		
B	40			50				60			60		
D	600	700	800	500	600	700	800	600	700	800	800	900	1000
E	625	725	825	525	625	725	825	625	725	825	825	925	1025
G1	210			245				280			290		
L	400			450				500			550		
M	38			38				38			38		
W	124			144				169			189		
kg	135	157	180	180	210	252	288	260	303	340	500	562	625

Cod. 5.80.0C360 5.80.0C370 5.80.0C380 5.80.0C450 5.80.0C460 5.80.0C470 5.80.0C480 5.80.0C560 5.80.0C570 5.80.0C580 5.80.0C680 5.80.0C690 5.80.0C610

This type of vise even if it is part of the FMS series is not suitable for double or self-centering clamping

Cod. 5.80.0G360 5.80.0G370 5.80.0G380 5.80.0G450 5.80.0G460 5.80.0G470 5.80.0G480 5.80.0G560 5.80.0G570 5.80.0G580 5.80.0G680 5.80.0G690 5.80.0G610

Art. 800C

**GANASCE REVERSIBILI
REVERSIBLE JAWS**

Esplso di cubo-morsa FMS con ganasce piane per il serraggio di 4 pezzi
 Explose of FMS vise tower with straight jaws for 4 clamping stations

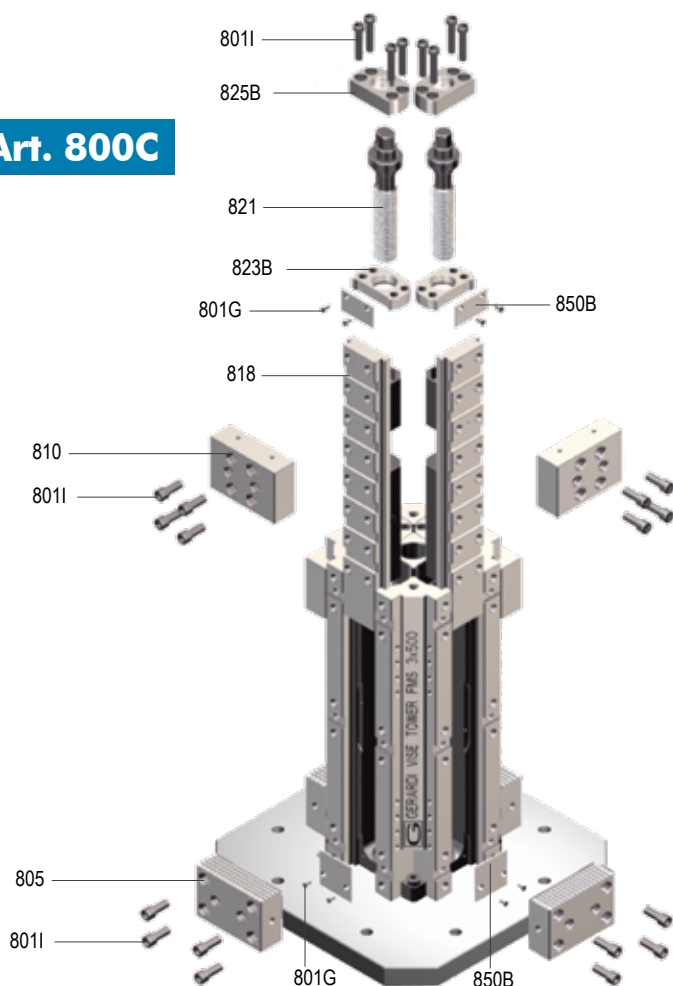

Art.	Pag.	Art.	Pag.
801G	5.61	-	-
801I	5.61	-	-
810	5.56	-	-
818	5.52	-	-
821	5.53	-	-
823B	5.59	-	-
825B	5.59	-	-
850B	5.61	-	-
-	-	-	-
-	-	-	-
-	-	-	-

Tipo (grandezza) morsa / Vise type (size)	kN	1		2				3	
		25 kN		25 kN				30 kN	
Apertura massima / Max. opening	A	2 x 16	2 x 66	2 x 54	2 x 104	2 x 154	2 x 204	2 x 74	2 x 124
	B	25		30				40	
	D	200	300	300	400	500	600	400	500
	E	232	332	320	420	520	620	425	525
	G1	120		175				210	
	L	300		350				400	
	M	33		33				38	
	W	74		94				124	
	kg	30	45	53	70	88	106	90	112
	Cod.	5.86.0C120	5.86.0C130	5.86.0C230	5.86.0C240	5.86.0C250	5.86.0C260	5.86.0C340	5.86.0C350

Art. 860C

Cubo-morsa FMS doppio per il serraggio di 8 pezzi



Double FMS vise tower for 8 clamping stations

Art. 855C

Modulo base cubo morsa FMS doppia (senza ganasce)
 FMS Double vise tower base (without jaws)

Cod.	5.85.5C120	5.85.5C130	5.85.5C230	5.85.5C240	5.85.5C250	5.85.5C260	5.85.5C340	5.85.5C350

GANASCE REVERSIBILI REVERSIBLE JAWS

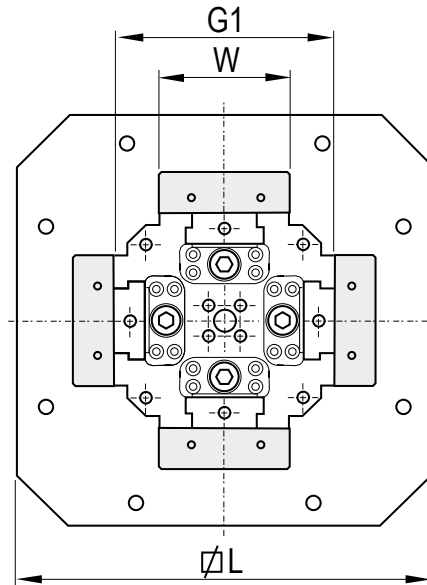
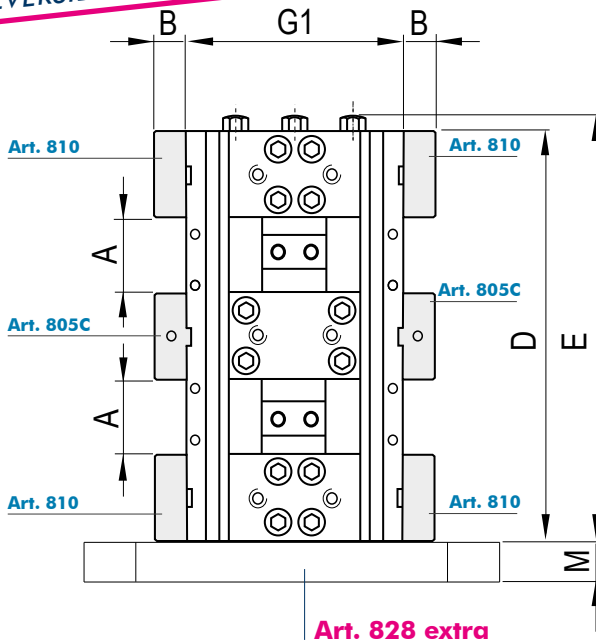

- Dotazione standard per Art. 860C
- 1 chiave a pipa Art. 375
 - 4 arresti laterali Art. 370
 - 2 coppie di tasselli di posizionamento per cava da 16 mm Art. 297
 - 1 goliare di sollevamento Art. 848
 - Imballo in cassa di legno
 - Meccanismo 3a mano

- Standard equipment for Art. 860C
- 1 box wrench Art. 375
 - 4 workstops Art. 370
 - 2 pair of positioning key-nuts for 16 mm slot Art. 297
 - 1 lifting hook Art. 848
 - Wooden box packaging
 - Third hand device

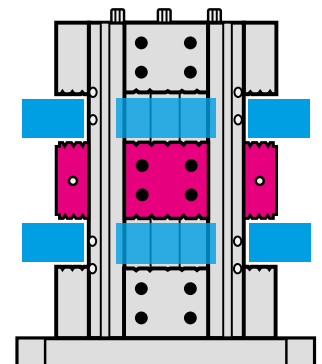

	3 30 kN			4 30 kN				5 32 kN			6 32 kN		
A	2 x 174	2 x 224	2 x 274	2 x 103	2 x 153	2 x 203	2 x 253	2 x 138	2 x 188	2 x 238	2 x 238	2 x 288	2 x 338
B	40			50				60			60		
D	600	700	800	500	600	700	800	600	700	800	800	900	1000
E	625	725	825	525	625	725	825	625	725	825	825	925	1025
G1	210			245				280			290		
L	400			450				500			550		
M	38			38				38			38		
W	124			144				169			189		
kg	135	157	180	180	210	252	288	260	303	340	500	562	625

Cod. 5.86.0C360 5.86.0C370 5.86.0C380 5.86.0C450 5.86.0C460 5.86.0C470 5.86.0C480 5.86.0C560 5.86.0C570 5.86.0C580 5.86.0C680 5.86.0C690 5.86.0C610

Cod. 5.85.5C360 5.85.5C370 5.85.5C380 5.85.5C450 5.85.5C460 5.85.5C470 5.85.5C480 5.85.5C560 5.85.5C570 5.85.5C580 5.85.5C680 5.85.5C690 5.85.5C610

GANASCE REVERSIBILI
REVERSIBLE JAWS

Art. 860C

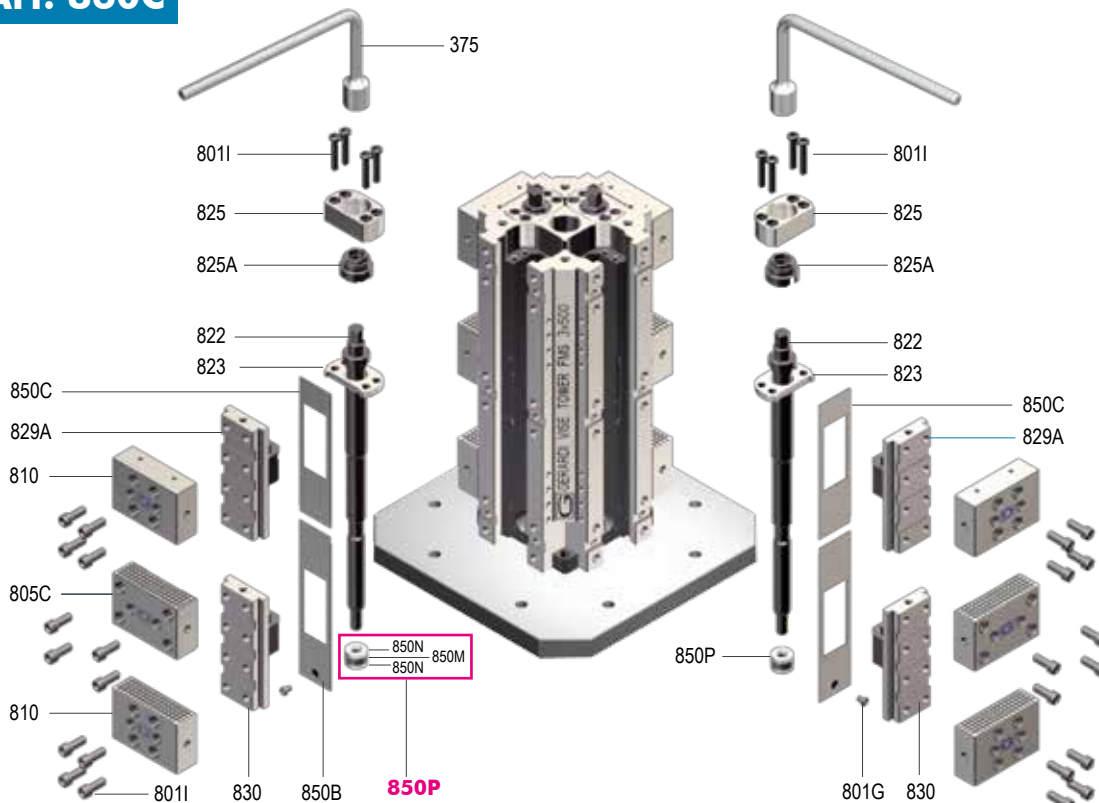

Art.	Pag.
375	4.35
801G	5.61
8011	5.61
805C	5.54
810	5.56
822	5.53
823	5.59
825	5.59
825A	5.61
829A	5.52
830	5.52
850B	5.61
850C	5.61
850P	5.61
-	-
-	-
-	-

Tipo (grandezza) morsa / Vise type (size)	kN	1		2				3	
		25 kN		25 kN				30 kN	
Apertura massima / Max. opening	A	2 x 60	2 x 110	2 x 118	2 x 168	2 x 218	2 x 268	2 x 162	2 x 212

Art. 863C

Cubo morsa FMS doppio con ganasce a gradino per il serraggio di 8 pezzi

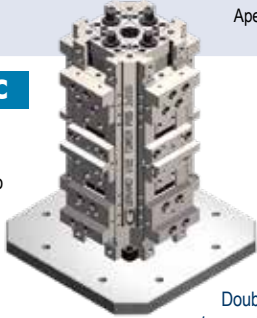

Double FMS vise tower with step-type jaws for 8 clamping stations

Cod.	5.86.3C120	5.86.3C130	5.86.3C230	5.86.3C240	5.86.3C250	5.86.3C260	5.86.3C340	5.86.3C350
------	------------	------------	------------	------------	------------	------------	------------	------------

Ø Apertura Minima / Massima / Minimum - Max Opening

A	10 / 25	10 / 50				25 / 100		
---	---------	---------	--	--	--	----------	--	--

Art. 870C

Cubo morsa FMS autocentrante con ganasce prismatiche

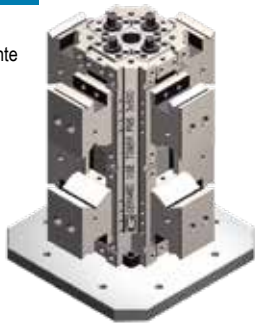

Self-centering FMS vise tower with prismatic jaws

Cod.	5.87.0C120	5.87.0C130	5.87.0C230	5.87.0C240	5.87.0C250	5.87.0C260	5.87.0C340	5.87.0C350
------	------------	------------	------------	------------	------------	------------	------------	------------

D	200	300	300	400	500	600	400	500
E	232	332	320	420	520	620	425	525
G1	120			175			210	
L	300			350			400	
M	33			33			38	
W	74			94			124	
W1	60			75			100	
kg	42	63	68	90	113	130	118	147

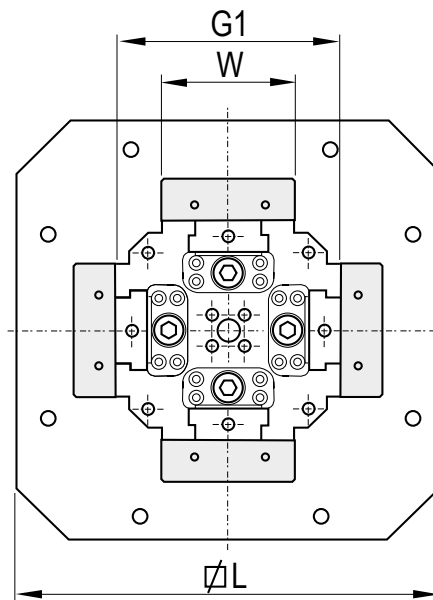
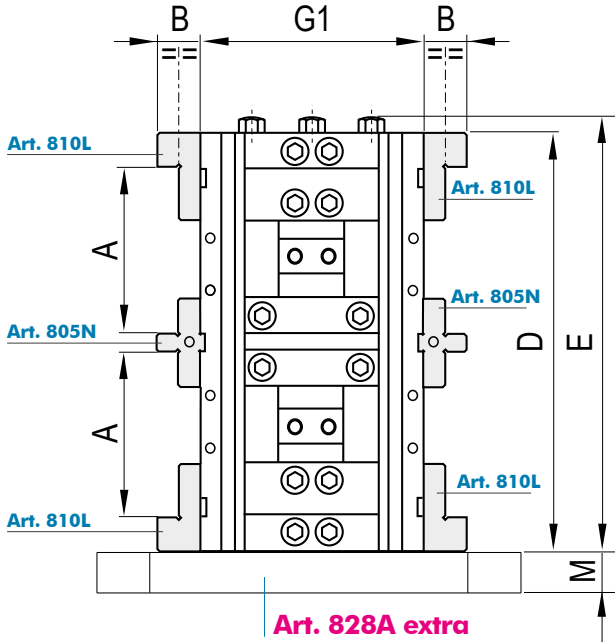

Dotazione standard per Art. 860C

- 1 chiave a pipa Art. 375
- 4 arresti laterali Art. 370
- 2 coppie di tasselli di posizionamento per cava da 16 mm Art. 297
- 1 goliare di sollevamento Art. 848
- Imballo in cassa di legno
- Meccanismo 3a mano

Standard equipment for Art. 860C

- 1 box wrench Art. 375
- 4 workstops Art. 370
- 2 pair of positioning key-nuts for 16 mm slot Art. 297
- 1 lifting hook Art. 848
- Wooden box packaging
- Third hand device

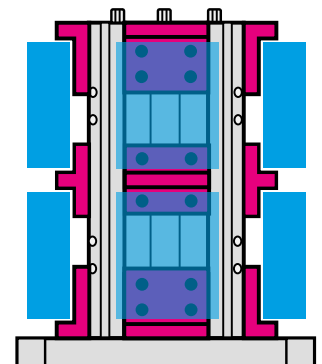

3 30 kN			4 30 kN				5 32 kN			6 32 kN			
A	2 x 262	2 x 312	2 x 362	2 x 204	2 x 254	2 x 304	2 x 354	2 x 254	2 x 304	2 x 354	2 x 354	2 x 404	2 x 454

Cod.	5.86.3C360	5.86.3C370	5.86.3C380	5.86.3C450	5.86.3C460	5.86.3C470	5.86.3C480	5.86.3C560	5.86.3C570	5.86.3C580	5.86.3C680	5.86.3C690	5.86.3C610
------	------------	------------	------------	------------	------------	------------	------------	------------	------------	------------	------------	------------	------------

A	25 / 100			30 / 150				35 / 200			40 / 300		
---	----------	--	--	----------	--	--	--	----------	--	--	----------	--	--

Cod.	5.87.0C360	5.87.0C370	5.87.0C380	5.87.0C450	5.87.0C460	5.87.0C470	5.87.0C480	5.87.0C560	5.87.0C570	5.87.0C580	5.87.0C680	5.87.0C690	5.87.0C610
------	------------	------------	------------	------------	------------	------------	------------	------------	------------	------------	------------	------------	------------

D	600	700	800	500	600	700	800	600	700	800	800	900	1000
E	625	725	825	525	625	725	825	625	725	825	825	925	1025
G1	210				245				280		290		
L	400				450				500		550		
M	38				38				38		38		
W	124				144				169		189		
W1	100				132				140		160		
kg	177	206	236	242	290	339	388	328	383	437	656	738	820

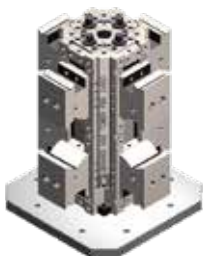
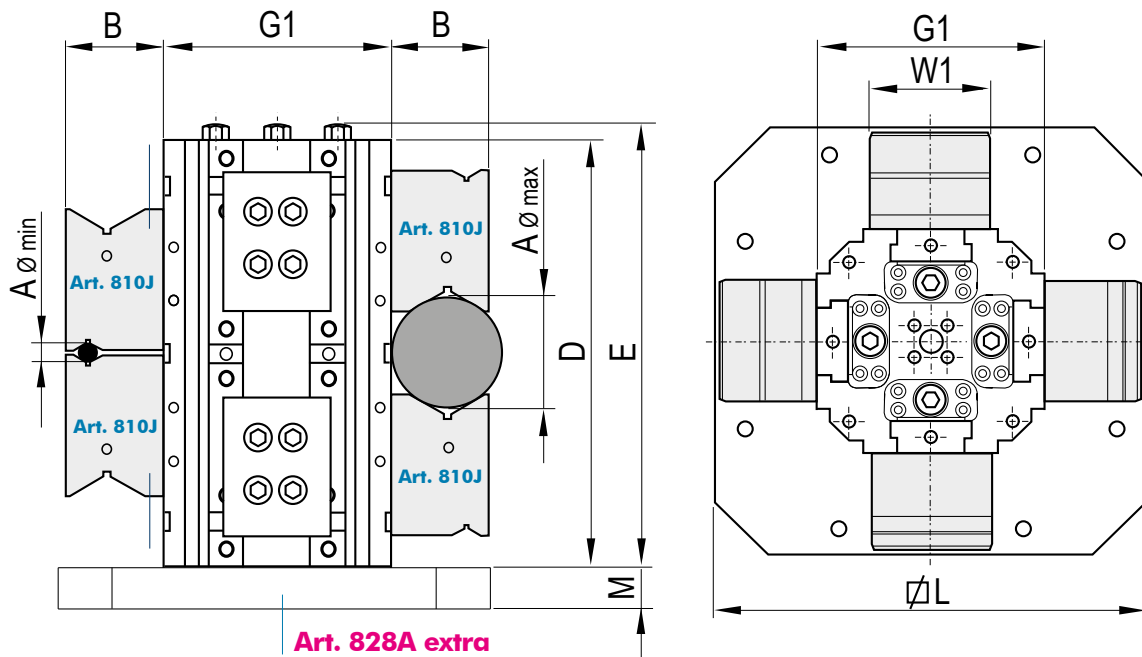

Dotazione standard per
Art. 863C e Art. 870C:

- 1 chiave a pipa Art. 375
- 4 arresti laterali Art. 370
- 2 coppie di tasselli di posizionamento per cava da 16 mm Art. 297
- 1 golphare di sollevamento Art. 848
- Imballo in cassetta di legno
- Meccanismo 3a mano

Standard equipment for
Art. 863C and Art. 870C:

- 1 box wrench Art. 375
- 4 workstops Art. 370
- 2 pair of positioning key-nuts for 16 mm slot Art. 297
- 1 lifting hook Art. 848
- Packaging wooden box
- Third hand device

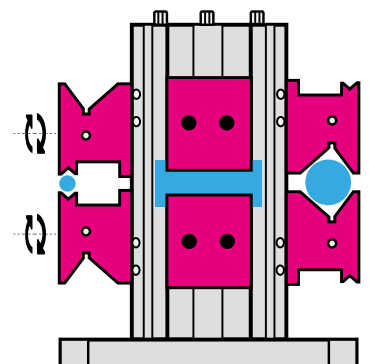

COMPONENTI PER CUBO FMS SPARE PARTS FOR FMS CUBE

Art. 855C



Precisione / Accuracy

$\pm 0,02\text{mm}$



Durezza / Hardened

HRC 58 \pm 2

- 1** Art.8011
VITI PER GANASCE
SCREWS FOR JAWS
- 2** Art.825A
GHIERA
NUT
- 3** Art.825B
PIASTRA DI CONTENIMENTO
SCREW HOLDING PLATE
- 4** Art.823
PIASTRA INTERMEDIA
MIDDLE PLATE
- 5** Art.804
CORPO BASE CUBO
CUBE BASE BODY
- 6** Art.822
VITE DI BLOCCAGGIO
MAIN SCREW
- 7** Art.850C
RIPARO
PROTECTION
- 8** Art.850B
RIPARO LATO VITE
PROTECTION SIDE SCREW
- 9** Art.830
SLITTA FILETTO DESTRO
SLIDE WITH RIGHT THREAD
- 10** Art.829A
SLITTA FILETTO SINISTRO
SLIDE WITH LEFT THREAD
- 11** Art.850P
DISPOSITIVO TERZA MANO
THIRD HAND DEVICE

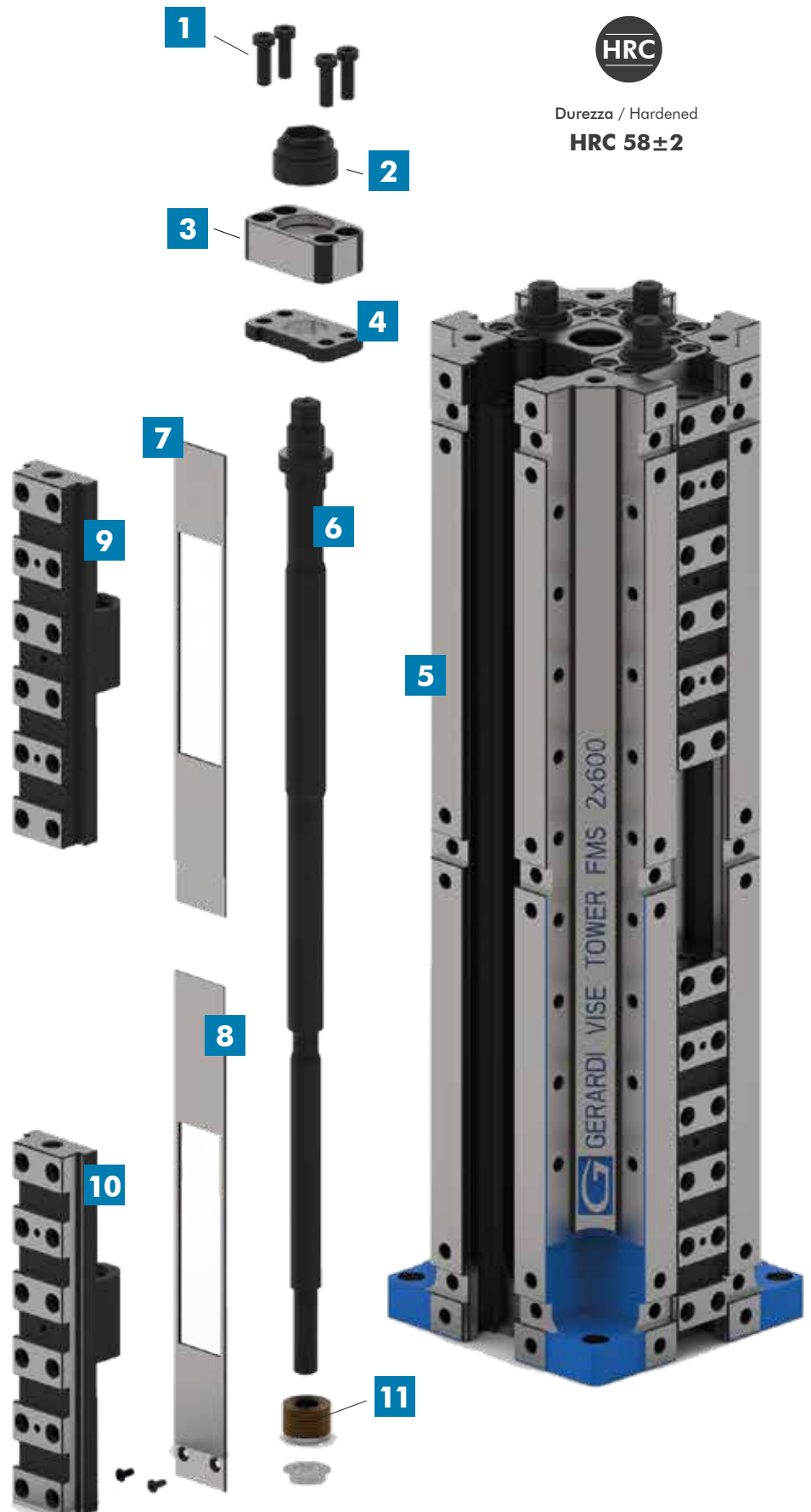

Tipo (grandezza) Type (size)	1		2				3				4				5			6			
Larghezza base / Base lenght	200	300	300	400	500	600	400	500	600	700	800	500	600	700	800	600	700	800	800	900	1000

Art. 804

Cod.	5.80.41200	5.80.41300	5.80.42300	5.80.42400	5.80.42500	5.80.42600	5.80.43400	5.80.43500	5.80.43600	5.80.43700	5.80.43800	5.80.44500	5.80.44600	5.80.44700	5.80.44800	5.80.45600	5.80.45700	5.80.45800	5.80.46800	5.80.46900	5.80.46100
------	------------	------------	------------	------------	------------	------------	------------	------------	------------	------------	------------	------------	------------	------------	------------	------------	------------	------------	------------	------------	------------

Corpo base cubo FMS.
 Disegni e tabella dimensionale
 FMS cube base body.
 Drawing and table dimension

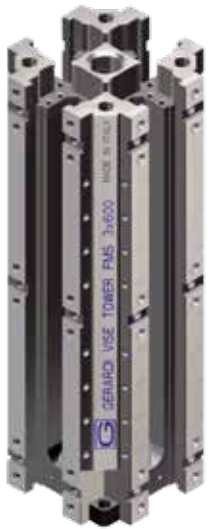

D	200	300	300	400	300	400	400	500	600	700	800	500	600	700	800	600	700	800	800	900	1000
F	140			175					210				245			280				290	
H	71	121	117	167	217	267	157	207	257	307	357	200	250	300	350	245	295	345	345	395	445
I	10			13					13				20			20				20	
J	10			12					12				18			18				18	
K	13			13					13				20			20				20	
L	21			25					35				42			47				47	
M	16			16					16				16			16				16	
N	45			53					76				86			96				110	
O	35			41					61				71			81				94	
P	M10			M12					M12				M16			M16				M20	
Q	11			13					13				13			17				17	
R	-			100					120				150			150				150	
S	-			40					40				40			50				50	
T	-			120					16				16			16				210	
U	M8			M10					M12				M16			M16				M20	
V	M8			M10					M12				M12			M12				M12	
Z	M10			M10					M10				M10			M10				M10	
X	75			95					125				145			170				190	
Y	70			85					110				125			140				130	
AB	32			40					50				60			68				68	
AC	56			70					92				108			126				144	
AD	56			68					92				106			126				144	
AE	50	70		70					100				100			100				125	
AF	10	25		50					50				50			50				50	
AG	49			62					62				80			95				105	
AH	41			53					72				70			82				95	

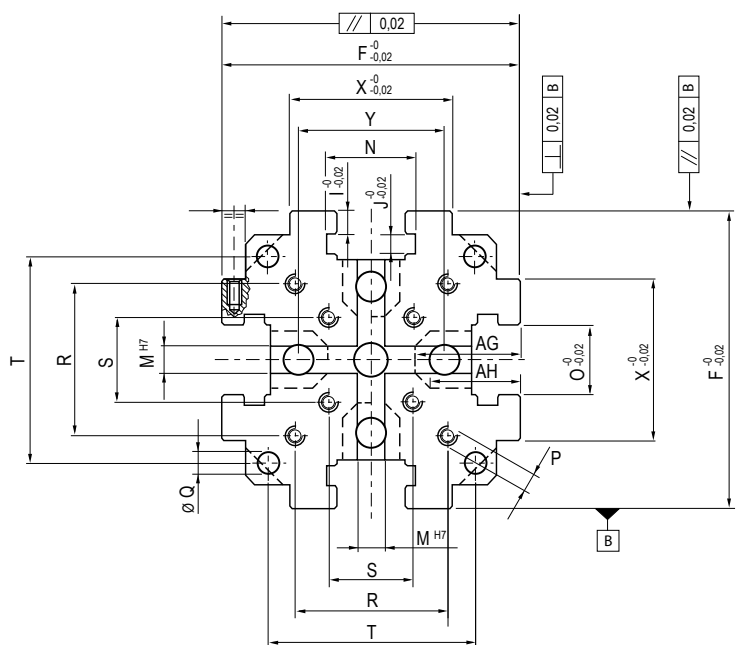
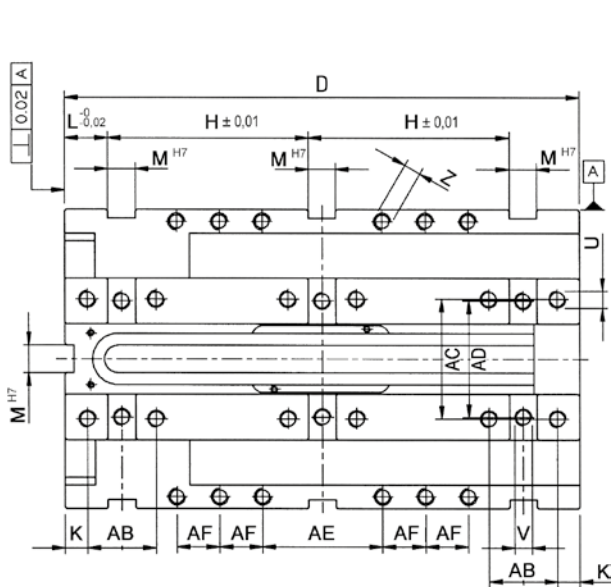

Tipo (grandezza) morsa / Vise type (size)
Art. 801

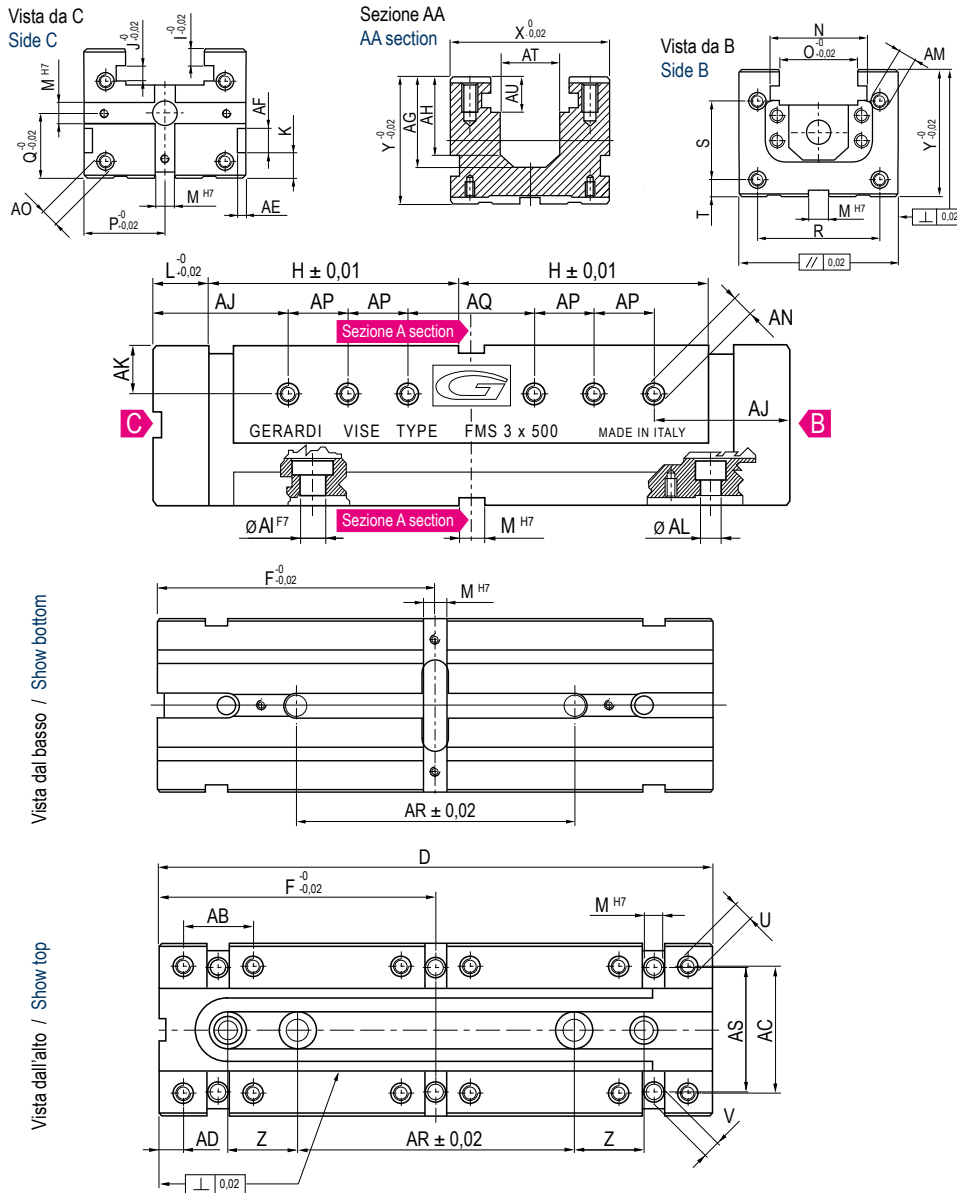
 Base morsa FMS. Disegni e tabella dimensionale
 FMS vise base body. Drawing and table dimension

	1		2	
kg	4,7	7,3	12,8	19
Cod.	5.80.11200	5.80.11300	5.80.12300	5.80.12400
D	200	300	300	400
F	100	150	150	200
H	71	121	117	167
I	10		13	
J	10		12	
K	15		20	
L	21		25	
M	16		16	
N	45		53	
O	35		41	
P	37,5		47,5	
Q	35		45	
R	52		70	
S	30		48	
T	20		22	
U	M8		M10	
V	M8		M10	
Z	50		50	
X	75		95	
Y	70		90	
AB	32		40	
AC	56		70	
AD	13		13	
AE	4		6	
AF	16		16	
AG	49		62	
AH	41		53	
AI	Ø 16 X 2		Ø 16 X 2	
AJ	55		65	
AK	20		27	
AL	n°0	n°2	n° 2	n° 2
AM	M10		M10	
AN	M10		M10	
AO	n°8	n°12	n° 12	n° 16
AP	M10		M10	
AQ	20	25	50	50
AR	50	70	70	70
AS	100	200	200	200
AT	56		68	
AU	28		34	
	23		28	

PIASTRE D'INTERFACCIA ZERO POINT
Tipo (grandezza) / Type (size)
Art. 62
FMS

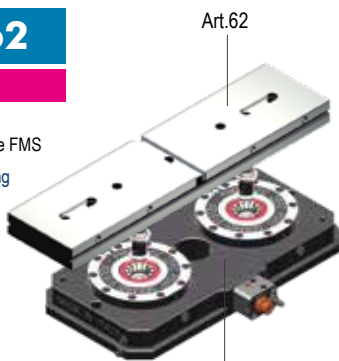
 Piastra di interfaccia
 Zero Point per morse FMS
 Zero Point connecting
 plate for FMS vises

Art.81P

 Tiranti e viti INCLUSI
 Pull Studs and screws INCLUDED

Art. 81P

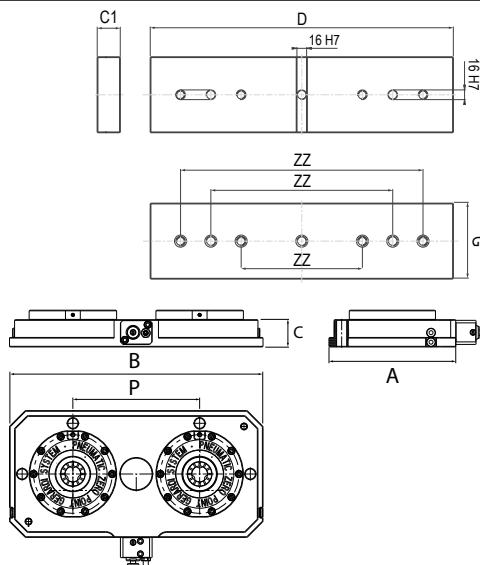
 Piastra Zero Point in acciaio con montaggio incassato
 Zero Point steel plate built-in mounting

	1		2	
D	232	332	300	400
G	75		95	
C1	38		38	
ZZ	200 / 300		200 / 300 / 400	
kg	5	7	11	13,4
Cod.	5.62.12000	5.62.13000	5.62.23000	5.62.24000
A	200		200	
B	400		400	
C	43		43	
Art. 665	Tipo / Type T.2		Tipo / Type T.2	
P	200		200	
kg	29		29	
Cod.	9.81.P2040S2		9.81.P2040S2	

	2		3					4				5			6		
kg	23	27	26	31	39	46	52	47	56	65	75	71	82	94	140	156	174
Cod.	5.80. 12500	5.80. 12600	5.80. 13400	5.80. 13500	5.80. 13600	5.80. 13700	5.80. 13800	5.80. 14500	5.80. 14600	5.80. 14700	5.80. 14800	5.80. 15600	5.80. 15700	5.80. 15800	5.80. 16800	5.80. 16900	5.80. 16100
D	500	600	400	500	600	700	800	500	600	700	800	600	700	800	800	900	1000
F	250	300	200	250	300	350	400	250	300	350	400	300	350	400	400	450	500
H	217	267	157	207	257	307	357	200	250	300	350	245	295	345	345	395	445
I	13									20					20		
J	12									18					18		
K	20									20					26		
L	25									42					47		
M	16									16					16		
N	53									86					110		
O	41									71					94		
P	47,5									72,5					95		
Q	45									60					80		
R	70									108					144		
S	48									72					100		
T	22									16					20		
U	M10									M16					M20		
V	M10									M12					M12		
Z	50									50					50		
X	95									145					190		
Y	90									120					160		
AB	40									60					68		
AC	70									108					144		
AD	13									20					20		
AE	6									10					10		
AF	16									16					16		
AG	62									80					105		
AH	53									70					95		
AI	Ø 16 x 2									Ø 16 x 2					Ø 16 x 2		
AJ	65									100					125		
AK	27									40					58		
AL	Ø 13									Ø 13					Ø 17		
AM	n° 4	n° 6	n° 2	n° 4	n° 6	n° 8	n° 10	n° 4	n° 6	n° 8	n° 10	n° 6	n° 8	n° 10	n° 10	n° 12	n° 14
AN	M10	M10	M10M	M10M	M10M	M10M	M10M	M10	M10	M10	M10	M10	M10	M10	M10	M10	M10
AO	M10	M10	M10	M10	M10	M10	M10	M16	M16	M16	M16	M16	M16	M16	M16	M16	M16
AP	50	50	50	50	50	50	50	50	50	50	50	50	50	50	50	50	50
AQ	70	70	70	70	70	70	70	100	100	100	100	100	100	100	100	100	100
AR	200	200	200	200	200	200	200	200	200	200	200	400	400	600	400	400	400
AS	68	68	68	68	68	68	68	106	106	106	106	126	126	126	126	126	126
AT	34	34	34	34	34	34	34	44	44	44	44	52	52	52	52	52	52
AU	28	28	28	28	28	28	28	41	41	41	41	41	41	41	41	41	41

ZERO POINT CONNECTING PLATES

	2		3					4				5			6		
D	500	600	400	500	600	700	800	500	600	700	800	600	700	800	800	900	1000
G	95									145					190		
C1	38									38					38		
ZZ	200 / 300 / 400		200 / 300 / 400					200 / 300 / 400				200 / 300 / 400			200 / 300 / 400		
kg	16,1	18,9	13,9	17,8	21,5	25,1	28,5	20,8	25	29,3	33,5	29	34	39	44	49	55
Cod.	5.62.25000	5.62.26000	5.62.34000	5.62.35000	5.62.36000	5.62.37000	5.62.38000	5.62.45000	5.62.46000	5.62.47000	5.62.48000	5.62.56000	5.62.57000	5.62.58000	5.62.68000	5.62.69000	5.62.61000
A	200		200	200	200	200	200	200	200	200	200	200	200	200	200	200	200
B	600		400	500	600	800	800	500	600	800	800	600	800	800	800	800	1000
C	43		43					43				43			53		
Art. 665	Tipo / Type T.2		Tipo / Type T.2					Tipo / Type T.2				Tipo / Type T.2			Tipo / Type T.3		
P	300		200	250	200x2	300x2	250	200x2	300x2	250	200x2	300x2	200x2	300x2	300x2	300x2	400x2
kg	42		29	41	42	59	41	42	59	41	42	59	42	59	68,5	81,5	
Cod.	9.81.P2060S2		9.81.P2040S2	9.81.P2060S2	9.81.P2060S3	9.81.P2080S3	9.81.P2060S2	9.81.P2060S3	9.81.P2080S3	9.81.P2060S3	9.81.P2080S3	9.81.P2060S3	9.81.P2080S3	9.81.P2060S3	9.81.P32080S3	9.81.P320100S3	

Tipo (grandezza) Type (size)	1		2				3					4				5			6		
Larghezza base / Base length	200	300	300	400	500	600	400	500	600	700	800	500	600	700	800	600	700	800	800	900	1000

Art. 818

Slitta integrale lunga
Solid long slide



Cod.	5.81. 81200	5.81. 81300	5.81. 82300	5.81. 82400	5.81. 82500	5.81. 82600	5.81. 83400	5.81. 83500	5.81. 83600	5.81. 83700	5.81. 83800	5.81. 84500	5.81. 84600	5.81. 84700	5.81. 84800	5.81. 85600	5.81. 85700	5.81. 85800	5.81. 86800	5.81. 86900	5.81. 86100
------	-------------	-------------	-------------	-------------	-------------	-------------	-------------	-------------	-------------	-------------	-------------	-------------	-------------	-------------	-------------	-------------	-------------	-------------	-------------	-------------	-------------

A	18																					
A1	18																					
A2	24																					
B	35																					
C	170	264	256	356	456	556	346	446	546	646	746	435	535	635	735	525	625	725	725	825	925	
D	M8																					
E	72	116	102	142	182	222	132	182	232	282	332	156	216	276	336	174	242	310	242	310	378	
F	48,5																					
G	15	18																				
H	2	3	2	3	4	5	2	3	4	5	6	2	3	4	5	2	3	4	2	3	4	
I	10																					
J	10																					
K	-	-	5	7	9																	
L	44																					
M	16																					
N	20																					
O	35																					
S	26	32																				
T	20																					
V	27																					
W	10	16																				

Art. 829A

Slitta con filetto destro
Slide with right thread



Cod.	5.82. 9A120	5.82. 9A130	5.82. 9A230	5.82. 9A240	5.82. 9A250	5.82. 9A260	5.82. 9A340	5.82. 9A350	5.82. 9A360	5.82. 9A370	5.82. 9A380	5.82. 9A450	5.82. 9A460	5.82. 9A470	5.82. 9A480	5.82. 9A560	5.82. 9A570	5.82. 9A580	5.82. 9A680	5.82. 9A690	5.82. 9A610
------	-------------	-------------	-------------	-------------	-------------	-------------	-------------	-------------	-------------	-------------	-------------	-------------	-------------	-------------	-------------	-------------	-------------	-------------	-------------	-------------	-------------

--	--	--	--	--	--	--	--	--	--	--	--	--	--	--	--	--	--	--	--	--	--	--

Art. 830

Slitta con filetto sinistro
Slide with left thread



Cod.	5.83. 01200	5.83. 01300	5.83. 02300	5.83. 02400	5.83. 02500	5.83. 02600	5.83. 03400	5.83. 03500	5.83. 03600	5.83. 03700	5.83. 03800	5.83. 04500	5.83. 04600	5.83. 04700	5.83. 04800	5.83. 05600	5.83. 05700	5.83. 05800	5.83. 06800	5.83. 06900	5.83. 06100
------	-------------	-------------	-------------	-------------	-------------	-------------	-------------	-------------	-------------	-------------	-------------	-------------	-------------	-------------	-------------	-------------	-------------	-------------	-------------	-------------	-------------

--	--	--	--	--	--	--	--	--	--	--	--	--	--	--	--	--	--	--	--	--	--	--

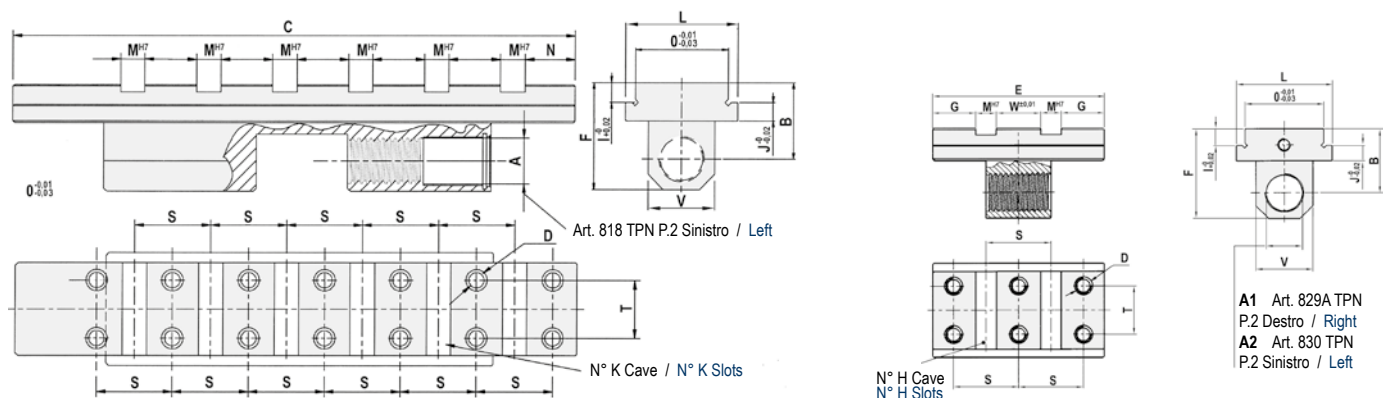

Tipo (grandezza) Type (size)	1		2			3					4				5			6			
Larghezza base / Base length	200	300	300	400	500	600	400	500	600	700	800	500	600	700	800	600	700	800	800	900	1000

Art. 821

Vite di bloccaggio con filetto sinistro
 Main screw left thread



Cod.	5.82.11300		5.82.12600			5.82.14800					5.82.14800				5.82.16100			5.82.16100			
A	18			24					30					30			36			36	
A1	18			18					24					24			30			30	
A2	20			24					30					30			36			36	
B	16			16					19					19			19			19	
C	-			-					-					-			-			-	
D	35			35					45					45			48			48	
E	20			25					30					30			30			30	
F	82			33					42					42			115			115	
G	13			12					16					16			15			15	
H	152			135					136					186			225			225	
I	65			90					118					118			135			135	
J	14			12					15					15			20			20	
K	5			12					26					26			55			55	
L	55			9					11					11			80			80	
M	14			19					24					24			30			30	
N	242	333	308	399	500	600	414	499	599	699	822	499	599	699	797	610	700	790	790	881	961
O	12	17	25	32	52	52	25	35	54	87	121	35	54	87	121	47	71	101	101	81	100
P	65	84	84	98	116	151	123	123	140	124	118	123	140	124	118	176	158	140	140	205	187
Q	32	66	66	106	134	164	82	132	160	226	282	132	160	226	282	124	192	256	256	245	308
R	68	85	75	94	116	136	118	118	140	124	118	118	140	124	118	176	158	140	140	205	187
S	44	6	38	49	62	77	41	66	80	113	136	66	80	113	136	62	96	128	128	120	154
T	32			32					38					38			45			45	
U	21		15		20				25					25			25			25	
AA	10			10					15					15			22			22	
AB	10			10					12					12			15			15	

Art. 822

Vite di bloccaggio con filetto destro e sinistro
 Main screw right and left thread

Viti con esagono maschio o femmina a seconda delle dimensioni
 Screw available with external or internal hexagon



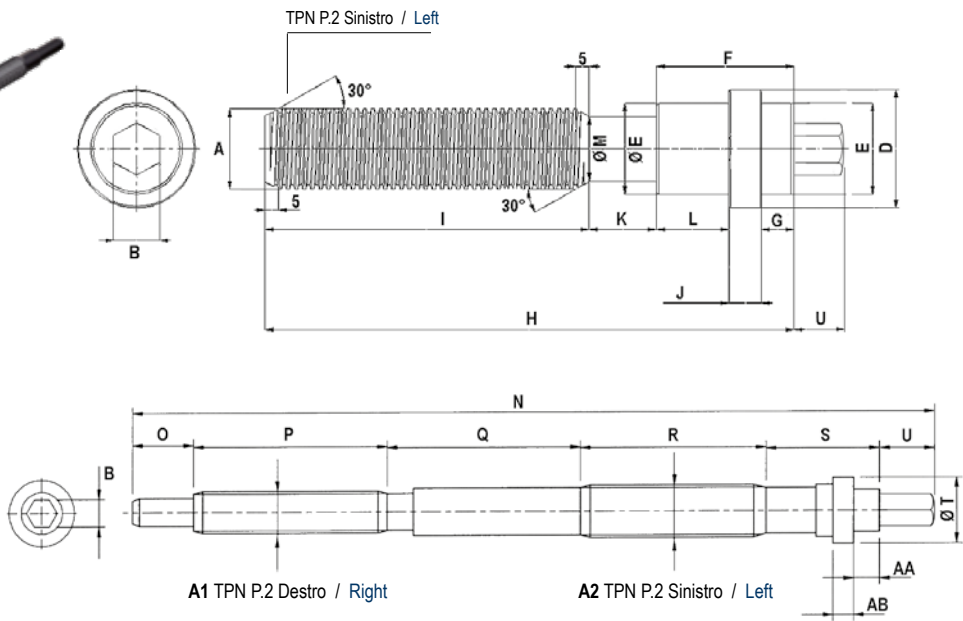

Cod.	5.82.21200	5.82.21300	5.82.22300	5.82.22400	5.82.22500	5.82.22600	5.82.23400	5.82.23500	5.82.23600	5.82.23700	5.82.23800	5.82.24500	5.82.24600	5.82.24700	5.82.24800	5.82.25600	5.82.25700	5.82.25800	5.82.26800	5.82.26900	5.82.26100	

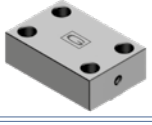

GANASCE FISSE PER MORSE FMS

FIXED JAWS FOR FMS VISES

Tipo (grandezza) / Type (size)	1	2	3	4	5	6
Art. 805* Ganascia fissa zigrinata da un lato Fixed jaw one side serrated 	Cod. 5.80.51000	5.80.52000	5.80.53000	5.80.54000	5.80.55000	5.80.56000
Art. 805A* Ganascia fissa liscia Smooth fixed jaw 	Cod. 5.80.5A100	5.80.5A200	5.80.5A300	5.80.5A400	5.80.5A500	5.80.5A600
Art. 805B* Ganascia fissa dolce Soft fixed jaw 	Cod. 5.80.5B100	5.80.5B200	5.80.5B300	5.80.5B400	5.80.5B500	5.80.5B600
Art. 805C* Ganascia fissa zigrinata da ambo i lati Fixed jaw serrated on both sides 	Cod. 5.80.5C100	5.80.5C200	5.80.5C300	5.80.5C400	5.80.5C500	5.80.5C600
Art. 870A* Ganascia fissa intermedia alta Fixed Intermediate high jaw 	Cod. 5.87.0A100	5.87.0A200	5.87.0A300	5.87.0A400	5.87.0A500	5.87.0A600

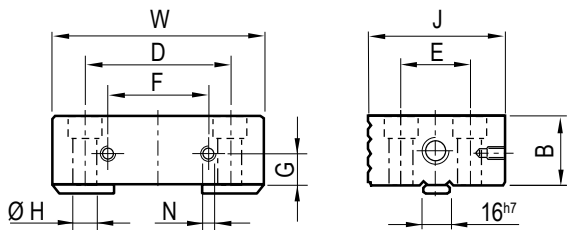
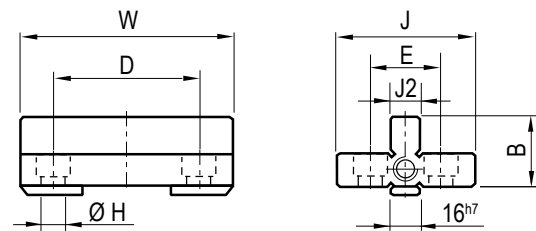
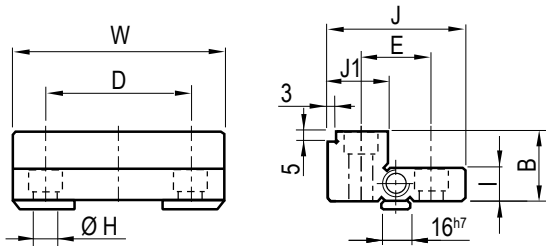
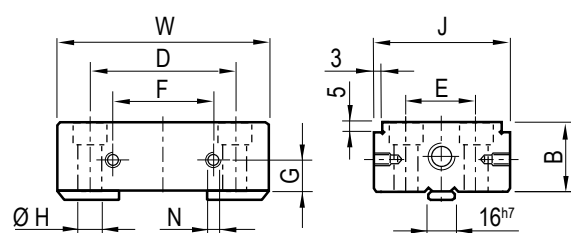
Art. 805 (Montata su Art. 860)
 (Assembled on Art. 860)

Art. 805N (Montata su Art. 863)
 (Assembled on Art. 863)

Art. 805O Ganascia fissa con gradino piccolo e grande
 Fixed jaw with small and large step

Art. 805F (Montata su Art. 866)
 (Assembled on Art. 866)

Tipo (grandezza) morsa / Vise (type) size

mm	1	2	3	4	5	6	Tolleranze Tolerance
W	74	94	124	144	169	189	-
J	56	64	84	98	108	108	- 0,02
J1	24	24	30	38	38	38	-
J2	16	16	16	16	16	16	-
B	25	30	40	50	60	60	- 0,02
D	56	70	92	108	126	144	-
E	32	40	50	60	68	68	-
F	40	50	65	65	65	100	-
G	10	10	15	20	25	25	-
H	9	11	13	17	17	22	-
I	12,5	15	20	25	30	30	- 0,02
N	M5	M6	M6	M6	M6	M6	-

* Set viti per fissaggio a richiesta - Fixing screws set on request

Tipo (grandezza) / Type (size)	1	2	3	4	5	6
Art. 805D* Ganascia fissa con gradino 3x5 zigrinata da un lato Fixed jaw with 3x5 step on side serrated 	Cod. 5.80.5D100	5.80.5D200	5.80.5D300	5.80.5D400	5.80.5D500	5.80.5D600
Art. 805E* Ganascia fissa con gradino 3x5 liscia Fixed jaw with 3x5 step smooth 	Cod. 5.80.5E100	5.80.5E200	5.80.5E300	5.80.5E400	5.80.5E500	5.80.5E600
Art. 805F* Ganascia fissa con doppio gradino 3x5 liscia Fixed jaw with double 3x5 step smooth 	Cod. 5.80.5F100	5.80.5F200	5.80.5F300	5.80.5F400	5.80.5F500	5.80.5F600
Art. 805G* Ganascia fissa con doppio gradino 3x5 zigrinata Fixed jaw with double 3x5 step serrated 	Cod. 5.80.5G100	5.80.5G200	5.80.5G300	5.80.5G400	5.80.5G500	5.80.5G600
Art. 805H* Ganascia fissa con prisma verticale Fixed jaw with vertical prism 	Cod. 5.80.5H100	5.80.5H200	5.80.5H300	5.80.5H400	5.80.5H500	5.80.5H600
Art. 805I* Ganascia fissa con doppio prisma verticale Fixed jaw with double vertical prism 	Cod. 5.80.5I100	5.80.5I200	5.80.5I300	5.80.5I400	5.80.5I500	5.80.5I600
Art. 805J* Ganascia fissa con prisma orizzontale Fixed jaw with horizontal prism 	Cod. 5.80.5J100	5.80.5J200	5.80.5J300	5.80.5J400	5.80.5J500	5.80.5J600
Art. 805K* Ganascia fissa con doppio prisma orizzontale Fixed jaw with double horizontal prism 	Cod. 5.80.5K100	5.80.5K200	5.80.5K300	5.80.5K400	5.80.5K500	5.80.5K600
Art. 805L* Ganascia fissa con gradino Step fixed jaw 	Cod. 5.80.5L100	5.80.5L200	5.80.5L300	5.80.5L400	5.80.5L500	5.80.5L600
Art. 805M* Ganascia fissa con gradino zigrinata da un lato Step fixed jaw one side serrated 	Cod. 5.80.5M100	5.80.5M200	5.80.5M300	5.80.5M400	5.80.5M500	5.80.5M600
Art. 805N* Ganascia fissa con doppio gradino Fixed jaw with double step 	Cod. 5.80.5N100	5.80.5N200	5.80.5N300	5.80.5N400	5.80.5N500	5.80.5N600
Art. 805O* Ganascia fissa con gradino piccolo e grande liscia da un lato Fixed jaw with small and large step on side smooth 	Cod. 5.80.5O100	5.80.5O200	5.80.5O300	5.80.5O400	5.80.5O500	5.80.5O600
Art. 805P* Ganascia fissa con gradino piccolo e grande zigrin. da un lato Fixed jaw with small and large step one side serrated 	Cod. 5.80.5P100	5.80.5P200	5.80.5P300	5.80.5P400	5.80.5P500	5.80.5P600
Art. 805Q* Ganascia fissa doppia con gradino piccolo e grande Double fixed jaw with small and large step 	Cod. 5.80.5Q100	5.80.5Q200	5.80.5Q300	5.80.5Q400	5.80.5Q500	5.80.5Q600
Art. 805R* Ganascia fissa in alluminio Fixed jaw aluminium 	Cod. 5.80.5R100	5.80.5R200	5.80.5R300	5.80.5R400	5.80.5R500	5.80.5R600
Art. 805T* Ganascia fissa doppia GRIP per forti serraggi GRIP Double fixed jaw for strongest clamping 	Cod. 5.80.5T100	5.80.5T200	5.80.5T300	5.80.5T400	5.80.5T500	5.80.5T600
Art. 805DT* Ganascia fissa a coda di rondine Dove tail fixed jaw 	Cod. 5.80.5DT10	5.80.5DT20	5.80.5DT30	5.80.5DT40	5.80.5DT50	5.80.5DT60

Richiedere scheda tecnica - Technical data sheet on request

* Set viti per fissaggio a richiesta - Set of fixing screws on request

GANASCE MOBILI PER MORSE FMS

MOVABLE JAWS FOR FMS VISES

Tipo (grandezza) / Type (size)	1	2	3	4	5	6
Art. 810* Ganascia mobile zigrinata da un lato Movable jaw one side serrated	Cod. 5.81.01000	5.81.02000	5.81.03000	5.81.04000	5.81.05000	5.81.06000
Art. 810A* Ganascia mobile liscia Smooth movable jaw	Cod. 5.81.0A100	5.81.0A200	5.81.0A300	5.81.0A400	5.81.0A500	5.81.0A600
Art. 810B* Ganascia mobile dolce Soft movable jaw	Cod. 5.81.0B100	5.81.0B200	5.81.0B300	5.81.0B400	5.81.0B500	5.81.0B600
Art. 810D* Ganascia mobile con gradino 3x5 zigrinata da un lato Movable jaw with 3x5 step on side serrated	Cod. 5.81.0D100	5.81.0D200	5.81.0D300	5.81.0D400	5.81.0D500	5.81.0D600
Art. 814* Base mobile per ganasce fisse Movable base for fixed jaws	Cod. 5.81.41000	5.81.42000	5.81.43000	5.81.44000	5.81.45000	5.81.46000

Predisposizione per tutte le ganasce FMS fisse - Fit all FMS fixed jaws

Art. 810 (Montata su Art. 860) / (Assembled on Art. 860)

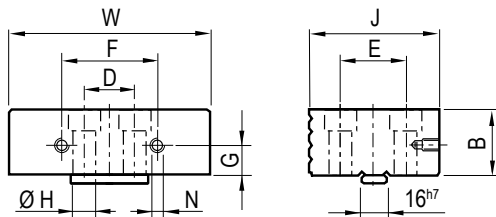

Art. 8100 Ganascia mobile con gradino piccolo e grande Movable jaw with small and large step

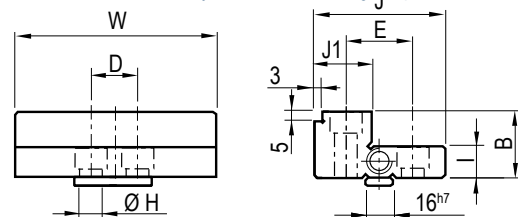

Art. 810J (Montata su Art. 870) / (Assembled on Art. 870)

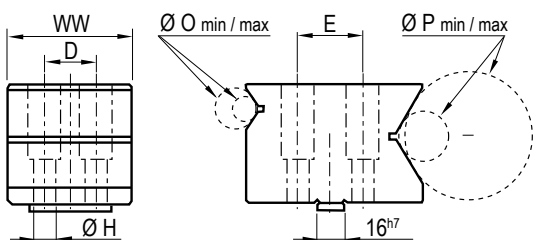

Art. 814 Base mobile per ganasce fisse - Movable base for fixed jaws

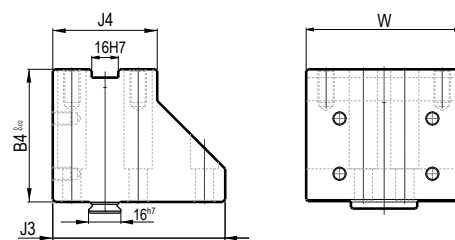

Tipo / Type	1x200	1x300	2	3	4	5	6	Tolleranze Tolerance
W	74		94	124	144	169	189	-
WW	60		75	100	132	140	160	-
B	25		30	40	50	60	60	-0,02
B4	60		80	90	110	120	160	-0,02
D	20		25	38	44	44	54	-
E	26	32	40	50	60	68	68	-
F	40		50	65	65	65	100	-
G	10		10	15	20	25	25	-
H	9		11	13	17	17	22	-
I	12,5		15	20	25	30	30	-0,02
J	56		64	82	98	108	108	-0,02
J1	24		24	30	38	38	38	-0,02
J3	76	76	104	134	158	169	189	-
J4	55		63	83	97	106	107	-
N	M5		M6	M6	M6	M6	M6	-
Ø O	10 / 15		20 / 30	25 / 30	20 / 60	35 / 70	40 / 80	-
Ø P	10 / 25		20 / 50	40 / 100	45 / 150	63 / 200	73 / 300	-

* Set viti per fissaggio a richiesta - Fixing screws set on request

Tipo (grandezza) / Type (size)

		1	2	3	4	5	6																																																								
Art. 810E*		Cod. 5.81.0E100	5.81.0E200	5.81.0E300	5.81.0E400	5.81.0E500	5.81.0E600																																																								
Ganascia mobile con gradino 3x5 liscia Movable jaw with 3x5 step smooth																																																															
Art. 810J*		Cod. 5.81.0J100	5.81.0J200	5.81.0J300	5.81.0J400	5.81.0J500	5.81.0J600																																																								
Ganascia mobile prismatica per tondi liscia Prismatic movable jaw for round parts smooth																																																															
Art. 810K*		Cod. 5.81.0K100	5.81.0K200	5.81.0K300	5.81.0K400	5.81.0K500	5.81.0K600																																																								
Ganascia mobile prismatica per tondi zigrinata Prismatic movable jaw for round parts serrated																																																															
Art. 810L*		Cod. 5.81.0L100	5.81.0L200	5.81.0L300	5.81.0L400	5.81.0L500	5.81.0L600																																																								
Ganascia mobile con gradino Step movable jaw																																																															
Art. 810M*		Cod. 5.81.0M100	5.81.0M200	5.81.0M300	5.81.0M400	5.81.0M500	5.81.0M600																																																								
Ganascia mobile con gradino zigrinata da un lato Step movable jaw one side serrated																																																															
Art. 810O*		Cod. 5.81.0O100	5.81.0O200	5.81.0O300	5.81.0O400	5.81.0O500	5.81.0O600																																																								
Ganascia mobile con gradino piccolo e grande Movable jaw with small and large step																																																															
Art. 810P*		Cod. 5.81.0P100	5.81.0P200	5.81.0P300	5.81.0P400	5.81.0P500	5.81.0P600																																																								
Ganascia mobile con gradino piccolo e grande zigrin. da un lato Movable jaw with small and large step one side serrated																																																															
Art. 810R*		Cod. 5.81.0R100	5.81.0R200	5.81.0R300	5.81.0R400	5.81.0R500	5.81.0R600																																																								
Ganascia mobile in alluminio Movable jaw aluminium																																																															
Art. 810T*		Cod. 5.81.0T100	5.81.0T200	5.81.0T300	5.81.0T400	5.81.0T500	5.81.0T600																																																								
Ganascia mobile GRIP per forti serraggi GRIP movable jaw for strongest clamping																																																															
Art. 810DT		Cod. 5.81.0DT10	5.81.0DT20	5.81.0DT30	5.81.0DT40	5.81.0DT50	5.81.0DT60																																																								
Ganascia mobile a coda di rondine Dove tail movable jaw																																																															
Art. 810V*		Cod. 5.81.0V100	5.81.0V200	5.81.0V300	5.81.0V400	5.81.0V500	5.81.0V600																																																								
Ganascia mobile con segmenti oscillanti Movable jaw with floating inserts																																																															
Art. 512*		Cod. 5.51.21000	5.51.22000	5.51.23000	5.51.24000	5.51.25000	5.51.26000																																																								
Ganascia intermedia Intermediate Jaw																																																															
512A																																																															
512B																																																															
313A																																																															
810P	512	805Q	512	810P																																																											
<table border="1"> <thead> <tr> <th>Type</th> <th>1</th> <th>2</th> <th>3</th> <th>4</th> <th>5</th> <th>6</th> </tr> </thead> <tbody> <tr> <td>W</td> <td>74</td> <td>94</td> <td>124</td> <td>144</td> <td>169</td> <td>189</td> </tr> <tr> <td>J</td> <td>25</td> <td>35</td> <td>40</td> <td>40</td> <td>50</td> <td>50</td> </tr> <tr> <td>J1</td> <td>15</td> <td>15</td> <td>20</td> <td>20</td> <td>30</td> <td>30</td> </tr> <tr> <td>J2</td> <td>9</td> <td>9</td> <td>14</td> <td>14</td> <td>19</td> <td>19</td> </tr> <tr> <td>B / B1</td> <td>12,5</td> <td>15</td> <td>20</td> <td>25</td> <td>30</td> <td>30</td> </tr> <tr> <td>D</td> <td>20</td> <td>25</td> <td>38</td> <td>44</td> <td>44</td> <td>54</td> </tr> <tr> <td>O</td> <td>34</td> <td>40</td> <td>60</td> <td>70</td> <td>81</td> <td>93</td> </tr> </tbody> </table>								Type	1	2	3	4	5	6	W	74	94	124	144	169	189	J	25	35	40	40	50	50	J1	15	15	20	20	30	30	J2	9	9	14	14	19	19	B / B1	12,5	15	20	25	30	30	D	20	25	38	44	44	54	O	34	40	60	70	81	93
Type	1	2	3	4	5	6																																																									
W	74	94	124	144	169	189																																																									
J	25	35	40	40	50	50																																																									
J1	15	15	20	20	30	30																																																									
J2	9	9	14	14	19	19																																																									
B / B1	12,5	15	20	25	30	30																																																									
D	20	25	38	44	44	54																																																									
O	34	40	60	70	81	93																																																									

* Set viti per fissaggio a richiesta - Set of fixing screws on request

PIASTRE GANASCE PIANE CON INSERTI GRIP

STRAIGHT INSERT GRIP JAW PLATES

Art. 547G

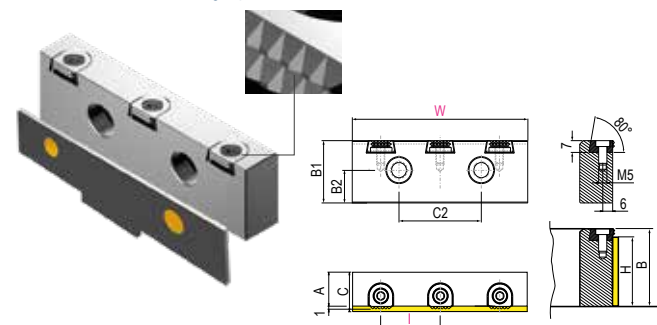
 Piastra Piana con inserti GRIP
 Straight plate with GRIP inserts

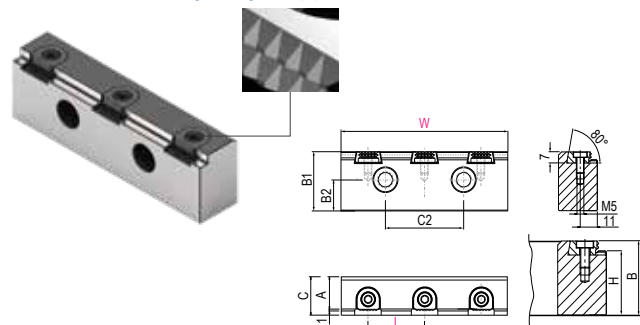
Art. 547K

 Piastra Piana a gradino integrale con inserti GRIP
 Straight integral step plate with GRIP inserts

Dotazione Standard - Standard Equipment

1 pc. Art.313 parallela magnetica - 1 pc. Art.313 magnetic parallel

Tippe Type	1	2	3	4	5	6
W	74	94	124	144	169	189
I	26	33	23,5	29,5	23	27
C	22,7	22,7	22,7	22,7	22,7	22,7
C2	40	50	65	65	65	100
B	25	30	40	50	60	60
B1	25	30	40	50	60	60
B2	10	10	15	20	25	25
A	20	20	20	20	20	20
H	20	25	35	45	55	55
Cod.	5.54.7G100	5.54.7G200	5.54.7G300	5.54.7G400	5.54.7G500	5.54.7G600

Tippe Type	1	2	3	4	5	6
W	74	94	124	144	169	189
I	26	33	23,5	29,5	23	27
C	25	25	25	25	25	25
C2	40	50	65	65	65	10
B	25	30	40	50	60	60
B1	25	30	40	50	60	60
B2	10	10	15	20	25	25
A	20	20	20	20	20	20
H	20	25	35	45	55	55
Cod.	5.54.7K100	5.54.7K200	5.54.7K300	5.54.7K400	5.54.7K500	5.54.7K600

INSERTI GRIP PER MORSE FMS

INSERT GRIP JAW PLATES FOR FMS VISES

Art. 220 G01

 Per materiali di durezza normale
 For standard workpieces hardness clamping



Cod. 4.22.01000 / G01

Art. 220 G02

 Per materiali di notevole durezza.
 For hardened workpieces clamping

Cod. 4.22.01000 / G02

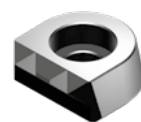
Art. 220 G11

 Per materiali teneri
 For soft material clamping

Cod. 4.22.01000 / G11

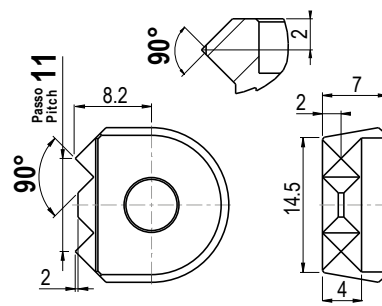
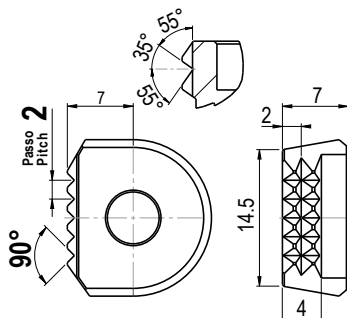
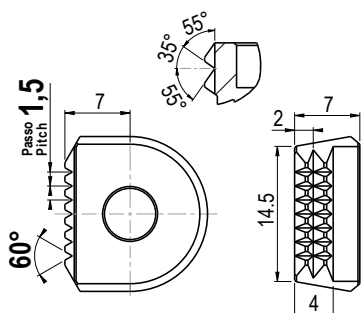

Tippe / Type	1	2	3	4	5	6
 Art.547G - Art.547K	 3 pcs each	 3 pcs each	 5 pcs each	 5 pcs each	 7 pcs each	 7 pcs each
Viti a testa bassa M5 x 10mm Low head screws M5 x 10mm	 3 pcs each	 3 pcs each	 5 pcs each	 5 pcs each	 7 pcs each	 7 pcs each

PIASTRE PER MORSE FMS

PLATES FOR FMS VISES

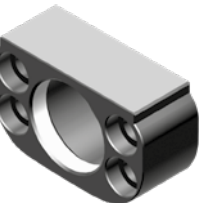
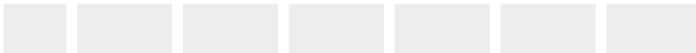
Tipo (grandezza) / Type (size)	1	2	3	4	5	6
Art. 823 Piastra intermedia per Art. 855 Middle plate for Art. 855						
	Cod.	5.82.31000	5.82.32000	5.82.33000	5.82.34000	5.82.35000
						
Art. 823B Piastra intermedia per Art. 800 Middle plate for Art. 800						
	Cod.	5.82.3B100	5.82.3B200	5.82.3B300	5.82.3B400	5.82.3B500
						
Art. 825 Piastra di contenimento vite per morse FMS per Art. 855 Screw holding plate for FMS vise for Art. 855						
	Cod.	5.82.51000	5.82.52000	5.82.53000	5.82.54000	5.82.55000
						
Art. 825B Piastra di contenimento vite per morse FMS per Art. 800 Screw holding plate for FMS vise for Art. 800						
	Cod.	5.82.5B100	5.82.5B200	5.82.5B300	5.82.5B400	5.82.5B500
						
Art. 825C Piastra di contenimento vite per morse FMS per Art. 855W Screw holding plate for FMS vise for Art. 855W						
	Cod.	5.82.5C100	5.82.5C200	5.82.5C300	5.82.5C400	5.82.5C500
						
Art. 831 Piastra di collegamento per 2 morse FMS montate verticalmente dorso a dorso o fianco a fianco Connecting plate for 2 FMS vises vertically mounted back-to-back or side by side						
	Cod.	5.83.11000	5.83.12000	5.83.13000	5.83.14000	5.83.15000
						
Art. 832 Piastra di collegamento per 4 morse FMS montate verticalmente dorso a dorso o fianco a fianco Connecting plate for 4 FMS vises vertically mounted back-to-back or side by side						
	Cod.	5.83.21000	5.83.22000	5.83.23000	5.83.24000	5.83.25000
						
Art. 833 Piastra di collegamento personalizzata per 2 morse FMS Connecting plate for 2 FMS vises tailor made						
	Cod.	5.83.31000	5.83.32000	5.83.33000	5.83.34000	5.83.35000
						
Art. 834 Piastra di collegamento personalizzata per 4 morse FMS Connecting plate for 4 FMS vises tailor made						
	Cod.	5.83.41000	5.83.42000	5.83.43000	5.83.44000	5.83.45000
						

PIASTRE BASE PER MORSE FMS

BASE PLATES FOR FMS VISES

Tipo (grandezza) / Type (size)
Art. 827A

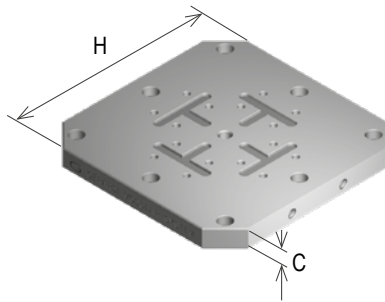
 Piastra base personalizzata per una o più morse
Bussola di centraggio Art. 852 compresa
 Tailor made head plate for one or more vises
Centering bushing Art. 852 included

	1	2	3	4	5	6	7
H	300	350	400	450	500	630	800
C	33	33	38	38	38	38	38
Kg	21,5	29,5	43,5	55	70	112	181
Cod.	5.82.7A100	5.82.7A200	5.82.7A300	5.82.7A400	5.82.7A500	5.82.7A600	5.82.7A700

Art. 828A

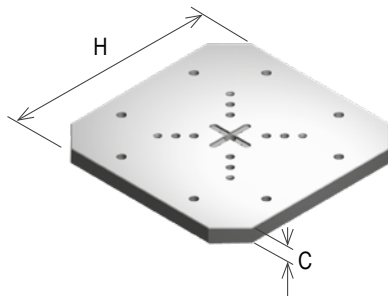
 Piastra base personalizzata per cubo morsa
bussola di centraggio Art. 852 compresa
 Tailor made head plate for vise tower
Centering bushing Art. 852 included

	1	2	3	4	5	6	7
H	300	350	400	450	500	630	800
C	33	33	38	38	38	38	38
Kg	22	30	44,5	56,5	71	113	182
Cod.	5.82.8A100	5.82.8A200	5.82.8A300	5.82.8A400	5.82.8A500	5.82.8A600	5.82.8A700

Tipo (grandezza) / Type (size)
Art. 835

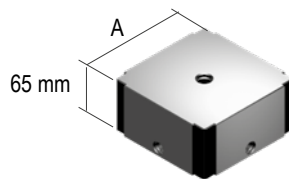
 Distanziale quadrato per 4 morse FMS
 Square spacer for 4 FMS vises

	1	2	3	4	5	6
A	75	95	125	145	170	190
Cod.	5.83.51000	5.83.52000	5.83.53000	5.83.54000	5.83.55000	5.83.56000

Art. 836

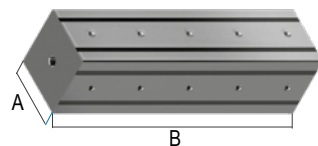
 Supporto quadrato per 4 morse FMS
 Square support for 4 FMS vises

	1	2	3	4	5	6
A	75	95	125	145	170	190
B	200	300	400	500	600	800
Cod.	5.83.61000	5.83.62000	5.83.63000	5.83.64000	5.83.65000	5.83.66000

Art. 837

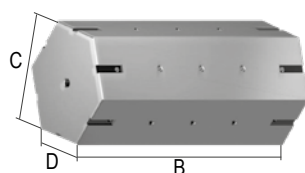
 Supporto esagonale per 6 morse FMS
 Exagon support for 6 FMS vises

	1	2	3	4	5	6
B	200	300	400	500	600	800
C	132	170	220	255	300	335
D	76 ~	98 ~	127 ~	147 ~	173 ~	193 ~
Cod.	5.83.71000	5.83.72000	5.83.73000	5.83.74000	5.83.75000	5.83.76000

Art. 838

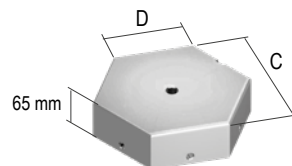
 Distanziale esagonale per 6 morse FMS
 Exagon spacer for 6 FMS vises

	1	2	3	4	5	6
C	132	170	220	255	300	335
D	76 ~	98 ~	127 ~	147 ~	173 ~	193 ~
Cod.	5.83.81000	5.83.82000	5.83.83000	5.83.84000	5.83.85000	5.83.86000

Art. 852









 Bussola di centraggio per piastra base
 Centering bushing for base plate

	1	2	3	4	5	6
Cod.	5.85.21000	5.85.22000	5.85.23000	5.85.24000	5.85.25000	5.85.26000

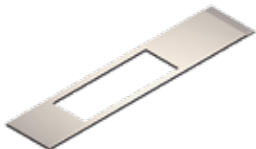
Art. 853

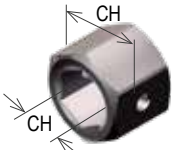
 Centraggio orizzontale per cubo FMS
 Horizontal centering for FMS cube





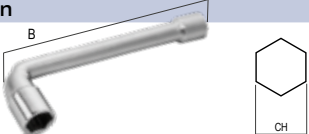

	1	2	3	4	5	6
Cod.	5.85.31000	5.85.32000	5.85.33000	5.85.34000	5.85.35000	5.85.36000

Tipo (grandezza) / Type (size)	1	2	3	4	5	6
Art. 825A Ghiera per morse e cubi FMS Nut for FMS vises and cubes 	Cod. 5.82.5A100	5.82.5A200	5.82.5A300	5.82.5A400	5.82.5A500	5.82.5A600
Art. 850B Riparo lato vite Protection side screw 	Cod. 5.85.0B100	5.85.0B200	5.85.0B300	5.85.0B400	5.85.0B500	5.85.0B600
Art. 850C Riparo Protection 	Cod. 5.85.0C100	5.85.0C200	5.85.0C300	5.85.0C400	5.85.0C500	5.85.0C600
Art. 850P Dispositivo "Terza Mano" "Third Hand" device 	Cod. 5.85.0P100	5.85.0P200	5.85.0P300	5.85.0P400	5.85.0P500	5.85.0P600
Art. 850E Bussola esagonale per innesto automatico Hexagonal bushing for automatic connection 	CH 12 / 22	14 / 24	19 / 30	19 / 30	27 / 40	27 / 40
	Cod. 5.85.0E100	5.85.0E200	5.85.0E300	5.85.0E400	5.85.0E500	5.85.0E600
Art. 850T Distanziale per morsa solo autocentrante Spacer for Self-centering vise only 	Cod. 5.85.0T100	5.85.0T200	5.85.0T300	5.85.0T400	5.85.0T500	5.85.0T600
Art. 850H Chiave esagonale per morsa FMS e cubo Hexagonal wrench for FMS vise and cube 	Cod. 5.85.0H100	5.85.0H200	5.85.0H300	5.85.0H400	5.85.0H500	
Art. 801S Piastrina di collegamento slitte morsa Slides vise connecting plate 	Cod. 5.80.1S100	5.80.1S200	5.80.1S300	5.80.1S400	5.80.1S500	5.80.1S600

*Foto indicativa
 *Indicative picture

Dimensioni / Dimension	CH	B	CH	B	CH	B	CH	B	CH	B	CH	B
Art.375 Chiave a pipa Box wrench 	16	250	16	250	19	250	19	250	19	250	19	250
	Cod. 4.37.516250	4.37.516250	4.37.519250	4.37.519250	4.37.519250	4.37.519250	4.37.519250	4.37.519250	4.37.519250	4.37.519250	4.37.519250	4.37.519250

RICAMBI PER MORSE Art.800 - SPARE PARTS FOR VISES Art.800

Art. 800E Guarnizione per slitta integrale O ring for solid slide 	Cod. 5.80.0E100	5.80.0E200	5.80.0E300	5.80.0E400	5.80.0E500	5.80.0E600
Art. 801G Grano di bloccaggio protezione centrale Setscrew for clamping central protection 	Cod. 5.80.1G100	5.80.1G200	5.80.1G300	5.80.1G400	5.80.1G500	5.80.1G600
Art. 800I Vite tcei per piastra di contenimento Hex.socket head screw for screw holding plate 	Cod. 5.80.0I100	5.80.0I200	5.80.0I300	5.80.0I400	5.80.0I500	5.80.0I600
Art. 801H Vite tcei per ganasce a gradino Hex.socket head screw for step jaws 	Cod. 5.80.1H100	5.80.1H200	5.80.1H300	5.80.1H400	5.80.1H500	5.80.1H600
Art. 801I Vite tcei per ganasce Hex.socket head screw for jaws 	Cod. 5.80.1I100	5.80.1I200	5.80.1I300	5.80.1I400	5.80.1I500	5.80.1I600

SERVOCOMANDI OLEODINAMICI PER MOTORI IDRAULICI

ELECTRO-HYDRAULIC POWER PACK FOR HYDRAULIC MOTORS

Tipo (grandezza) / Type (size)	1	2	3	4	5	6
Art. 566 Motore idraulico / Hydraulic motor	OMM32	OMP80	OMR200	OMR200	OMR200	OMR200
	bar			140		
	A mm	75	130	123	145	168
	B mm	70	100	104	119	139
	C mm	157	234	244	246	261
	Cod.	5.89.01000	5.89.02000	5.89.03000	5.89.04000	5.89.05000
						5.89.06000

Art.890

Art. 566 + Art. 571 + Art. 891 + Art. 892

Motore idraulico completo di piastra d' interfaccia, boccola e fine corsa elettronico regolabile
 Hydraulic motor complete with connecting plate, bushing and adjustable electronic proximity switch

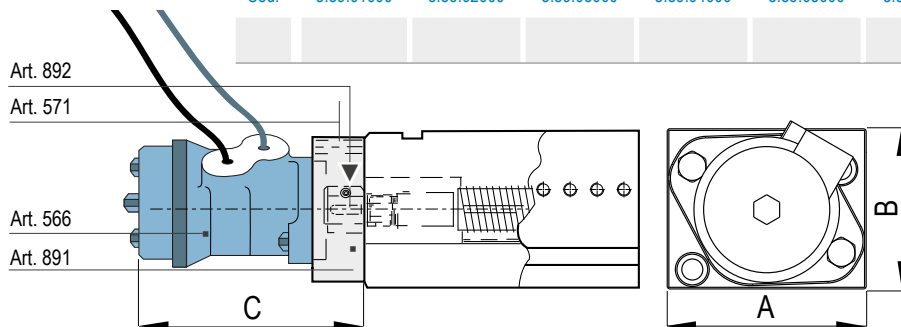

Art. 891

Piastra attacco motore idraulico / Hydraulic motor mounting plate

Cod.	5.89.11000	5.89.12000	5.89.13000	5.89.14000	5.89.15000	5.89.16000
------	------------	------------	------------	------------	------------	------------

Art. 892

Boccola di trascinamento vite motore / Drive bushing screw-motor

Cod.	5.89.21000	5.89.22000	5.89.23000	5.89.24000	5.89.25000	5.89.26000
------	------------	------------	------------	------------	------------	------------

Art. 566

Motore Idraulico / Hydraulic motor

Cod.	5.56.61000	5.56.62000	5.56.63000	5.56.63000	5.56.63000	5.56.63000
------	------------	------------	------------	------------	------------	------------

Art. 571

Fine corsa elettronico / Electronic proximity switch

Cod.	5.57.11000	5.57.12000	5.57.13000	5.57.14000	5.57.15000	5.57.16000
------	------------	------------	------------	------------	------------	------------

Tipo (grandezza) / Type (size)	1	2	3	4	5	6
Art.890K/1						
	Passo vite / screw pitch mm					
	2	2	2	2	3	3
	bar					
	130	100	100	100	120	120
	l/min					
	5	10	20	20	20	20
	Cod.	5.89.0K101	5.89.0K201	5.89.0K301	5.89.0K401	5.89.0K501
						5.89.0K601

Kit per automazione morse FMS
 Kit for FMS vises automation.

DATI TECNICI:
 IDROMOTORE: Art.566
 Motore elettrico Kw 5.5
 Portata Min. 40 litri al minuto
 Velocità apertura-chiusura morse da calcolarsi in base al digramma idromotore (vedi pag. 5.65)
 Per il diagramma forza di serraggio vedi pag. 5.74
 Pressione massima di esercizio: 140 bar

TECHNICAL DATA:
 HYDRAULIC MOTOR Art.566
 Electric motor kW 5.5
 Oil pumps: 40l/min
 Opening and closing speed of vise to be calculated from hydraulic motor diagram at page 5.65
For clamping forces diagram see pag. 5.75
Max operating pressure: 140 bar

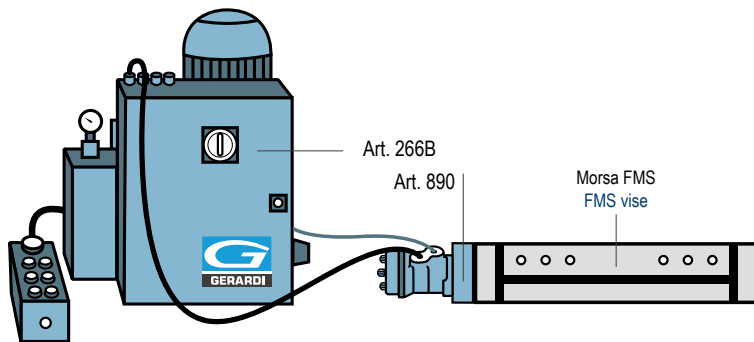

- COMPOSIZIONE COMPLETA DI:**
- N° 1 servocomando Art. 890
 - N° 1 centralina elettroidraulica Art. 266B/1
 - Comando manuale elettrico da pulsantiera con chiusura ed apertura indipendente, singola o simultanea
 - Regolazione forza di bloccaggio desiderata
 - Fine corsa elettronico regolabile

- COMPOSITION COMPLETE OF:**
- N° 1 hydraulic servo unit Art. 890
 - N° 1 electro-hydraulic power pack Art. 266B/1
 - Electrically controlled by manual switch board
 - Adjustable clamping force as required
 - Adjustable electronic proximity switch

Tubi e cavi di collegamento elettrici ed idraulici con massima lunghezza 1600 mm / Hydraulic pipes and electrical cables with max length 1600 mm

SERVOCOMANDI OLEODINAMICI PER MOTORI IDRAULICI

ELECTRO-HYDRAULIC POWER PACK FOR HYDRAULIC MOTORS

Tipo (grandezza) / Type (size)	1	2	3	4	5	6
Art.890K/2						
Passo vite / screw pitch mm	2	2	2	2	3	3
bar	130	100	100	100	120	120
l/min	10	20	40	40	40	40
Cod.	5.89.0K102	5.89.0K202	5.89.0K302	5.89.0K402	5.89.0K502	5.89.0K602

Art. 266B + 2 Art. 890

 Kit per automazione morse FMS
 Kit for FMS vises automation.

DATI TECNICI:

 IDROMOTORE: Art.566
 Motore elettrico Kw 5.5
 Portata Min. 40 litri al minuto
 Velocità apertura-chiusura morsa da calcolarsi in base al diagramma idromotore (vedi pag. 5.65)
 Per il diagramma forza di serraggio vedi pag. 5.74
 Pressione massima di esercizio: 140 bar

TECHNICAL DATA:

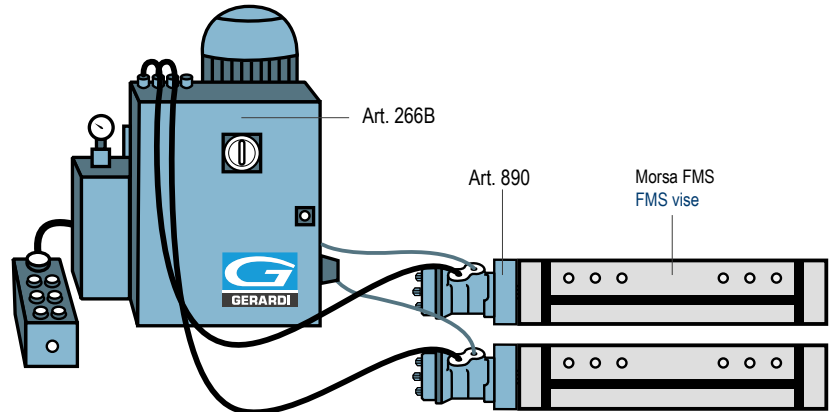
 HYDRAULIC MOTOR Art.566
 Electric motor kW 5,5
 Oil pumps: 40l/min
 Opening and closing speed of vise to be calculated from hydraulic motor diagram at page 5.65
For clamping forces diagram see pag. 5.75
Max operating pressure: 140 bar

COMPOSIZIONE COMPLETA DI:

- N° 2 servocomandi Art. 89
- N° 1 centralina elettroidraulica Art. 266B/1
- Comando manuale elettrico da pulsantiera con chiusura ed apertura indipendente, singola o simultanea
- Regolazione forza di bloccaggio desiderata
- Fine corsa elettronico regolabile

COMPOSITION COMPLETE OF:

- N° 2 hydraulic servo units Art. 890
- N° 1 electro-hydraulic power pack Art. 266B/1
- Electrically controlled by manual switch board
- Adjustable clamping force as required
- Adjustable electronic proximity switch

Tubi e cavi di collegamento elettrici ed idraulici con massima lunghezza 1600 mm / Hydraulic pipes and electrical cables with max length 1600 mm

Tipo (grandezza) / Type (size)	1	2	3	4	5	6
Art.890K/3						
Passo vite / screw pitch mm	2	2	2	2	3	3
bar	130	100	100	100	120	120
l/min	15	30	60	60	60	60
Cod.	5.89.0K103	5.89.0K203	5.89.0K303	5.89.0K403	5.89.0K503	5.89.0K603

Art. 266B + 3 Art. 890

 Kit per automazione morse FMS
 Kit for FMS vises automation.

DATI TECNICI:

 IDROMOTORE: Art.566
 Motore elettrico Kw 5.5
 Portata Min. 40 litri al minuto
 Velocità apertura-chiusura morsa da calcolarsi in base al diagramma idromotore (vedi pag. 5.65)
 Per il diagramma forza di serraggio vedi pag. 5.74
 Pressione massima di esercizio: 140 bar

TECHNICAL DATA:

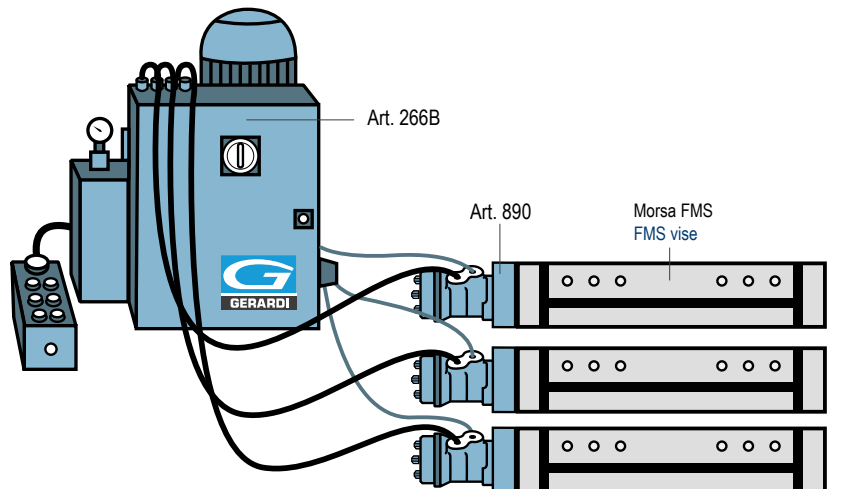
 HYDRAULIC MOTOR Art.566
 Electric motor kW 5,5
 Oil pumps: 40l/min
 Opening and closing speed of vise to be calculated from hydraulic motor diagram at page 5.65
For clamping forces diagram see pag. 5.75
Max operating pressure: 140 bar

COMPOSIZIONE COMPLETA DI:

- N° 3 servocomandi Art. 89
- N° 1 centralina elettroidraulica Art. 266B/1
- Comando manuale elettrico da pulsantiera con chiusura ed apertura indipendente, singola o simultanea
- Regolazione forza di bloccaggio desiderata
- Fine corsa elettronico regolabile

COMPOSITION COMPLETE OF:

- N° 3 hydraulic servo units Art. 890
- N° 1 electro-hydraulic power pack Art. 266B/1
- Electrically controlled by manual switch board
- Adjustable clamping force as required
- Adjustable electronic proximity switch

Tubi e cavi di collegamento elettrici ed idraulici con massima lunghezza 1600 mm / Hydraulic pipes and electrical cables with max length 1600 mm

SERVOCOMANDI OLEODINAMICI PER MOTORI IDRAULICI

ELECTRO-HYDRAULIC POWER PACK FOR HYDRAULIC MOTORS

Tipo (grandezza) / Type (size)	1	2	3	4	5	6
Passo vite / screw pitch mm	2	2	2	2	3	3
bar	130	100	100	100	120	120
l/min	20	40	80	80	80	80
Cod.	5.89.0K104	5.89.0K204	5.89.0K304	5.89.0K404	5.89.0K504	5.89.0K604

Art.890K/4

Art. 266B + 4 Art. 890

Kit per automazione morse FMS
 Kit for FMS vises automation.

DATI TECNICI:

IDROMOTORE: Art.566
 Motore elettrico Kw 5.5
 Portata Min. 40 litri al minuto
 Velocità apertura-chiusura morsa da calcolarsi in base al diagramma idromotore (vedi pag. 5.65)
 Per il diagramma forza di serraggio vedi pag. 5.74
 Pressione massima di esercizio: 140 bar

TECHNICAL DATA:

HYDRAULIC MOTOR Art.566
 Electric motor kW 5,5
 Oil pumps: 40l/min
 Opening and closing speed of vise to be calculated from hydraulic motor diagram at page 5.65
 For clamping forces diagram see pag. 5.75
 Max operating pressure: 140 bar

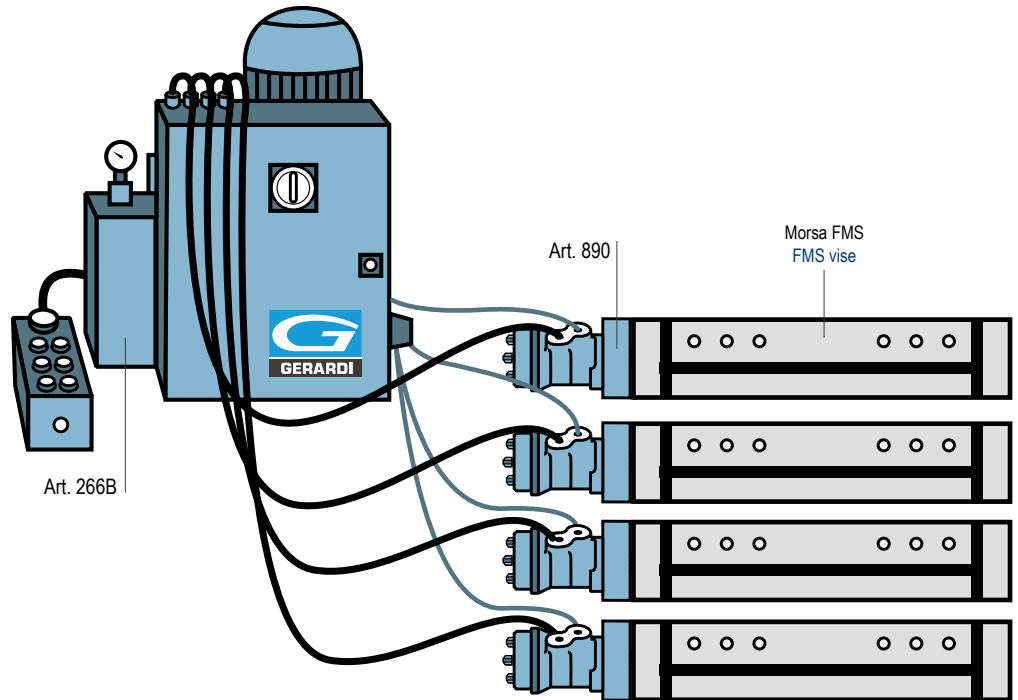

COMPOSIZIONE COMPLETA DI:

- N° 3 servocomandi Art. 89
- N° 1 centralina elettroidraulica Art. 266B/1
- Comando manuale elettrico da pulsantiera con chiusura ed apertura indipendente, singola o simultanea
- Regolazione forza di bloccaggio desiderata
- Fine corsa elettronico regolabile

COMPOSITION COMPLETE OF:

- N° 3 hydraulic servo units Art. 890
- N° 1 electro-hydraulic power pack Art. 266B/1
- Electrically controlled by manual switch board
- Adjustable clamping force as required
- Adjustable electronic proximity switch

Riduttore epicicloidale il quale consente di moltiplicare notevolmente la coppia sviluppata dal motore idraulico consentendo di arrivare a elevate forze di serraggio, fino a 480 kN

Epicyclic force reducer able to multiply greatly the torque generated by the hydraulic engine reaching a very high clamping force, maximum 480kN.

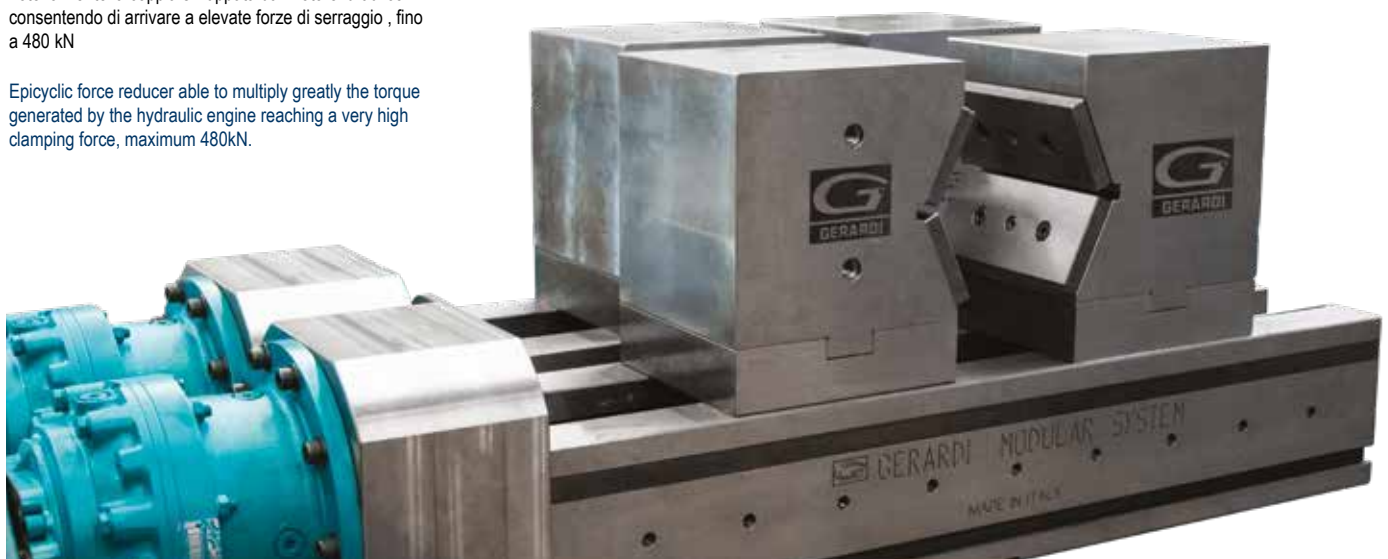

Tubi e cavi di collegamento elettrici ed idraulici con massima lunghezza 1600 mm / Hydraulic pipes and electrical cables with max length 1600 mm

DIAGRAMMI COPPIE MOTORI IDRAULICI

HYDRAULIC MOTOR TORQUE DIAGRAMS

Art.890 (Art.890) Motore idraulico
(Art.890) Hydraulic motor

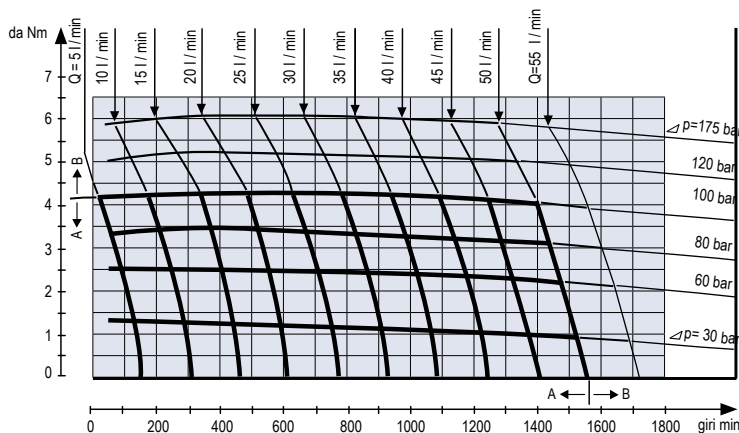
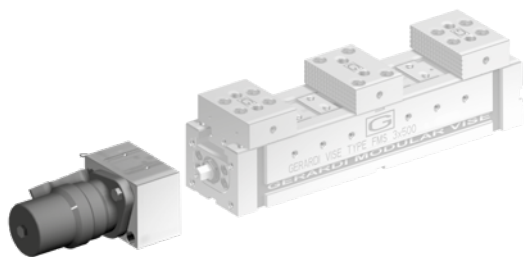

OMR 32

Morse FMS tipo 1 / Type 1 FMS vises

Art.890 (Art.890) Motore idraulico
(Art.890) Hydraulic motor

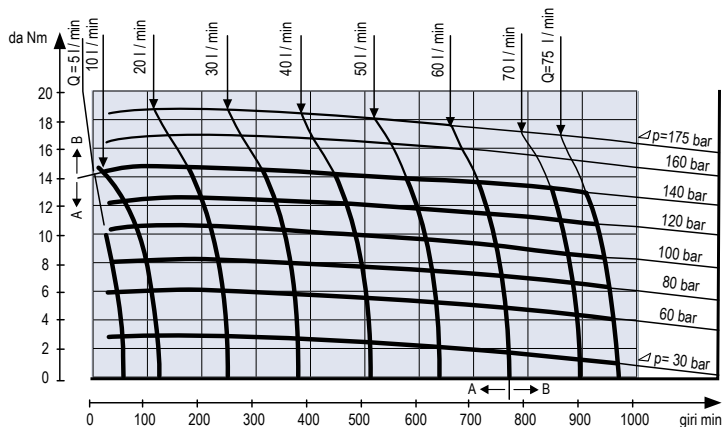
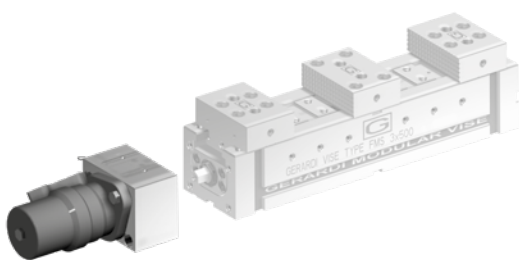

OMR 80

Morse FMS tipo 2 / Type 2 FMS vises

Art.890 (Art.890) Motore idraulico
(Art.890) Hydraulic motor

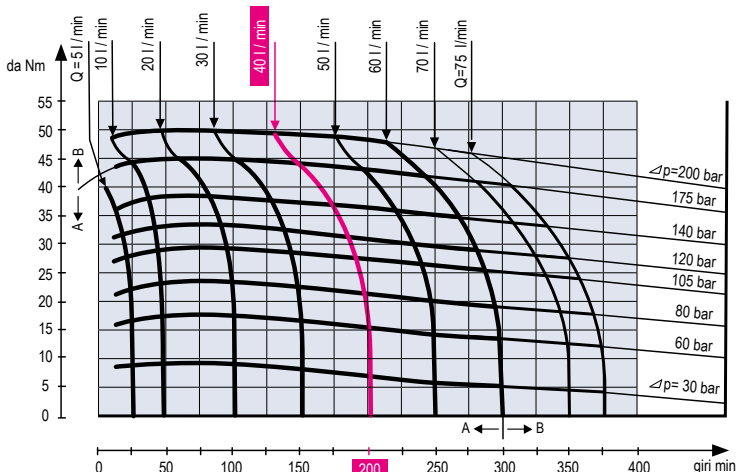
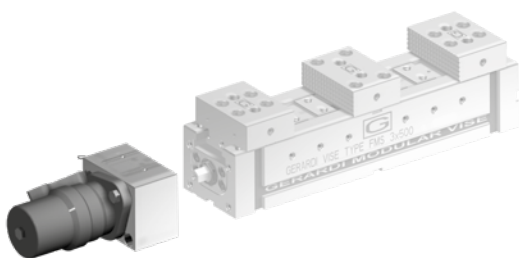

OMR 200

Morse FMS tipo 3 - 4 - 5 - 6 Type 3 - 4 - 5 - 6 FMS vises

VELOCITA' = Passo vite x giri/min (dati dalla portata di olio in l/min) - 25% circa per attriti e resistenze varie.

Esempio: Vite passo 2 mm; **Giri 200/min** (ipotizzando una portata olio di **40 l/min**); $V = 2 \times 200 = 400 - 25\% = 300$ mm/min per una morsa.

Per più morse dividere la velocità ottenuta per il numero delle morse impiegate.

SPEED = Screw pitch x RPM (that you get from oil pump of 40 l/min) about - 25% for friction and other resistance.

Example: Screw pitch 2mm; **RPM 200/min** (taking in consideration oil pump of **40 l/min**); $V = 2 \times 200 = 400 - 25\% = 300$ mm/min for one vise.

For more vises divide the speed obtained by the number of vises used.

DIVISORE AUTOMATICO DPG 250

AUTOMATIC DIVIDING HEAD DPG 250

Divisore automatico
Automatic dividing head

Dati tecnici
Technical Data

DPG 250

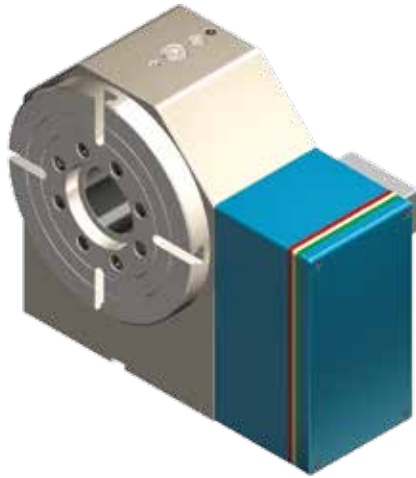

Diametro del divisore Dividing head diameter		250 mm
Diametro del foro passante Clearance hole diameter		70,5 mm
Altezza punta Center height		200 mm
Dimensione della scanalatura a T T-Slot width		12 mm
Sistema di bloccaggio Clamping system		Idrraulico Hydraulic
Forza frenante Clamping torque		3000 Nm
Motore Servo motor		3000 Max.g/min
Minimo incremento Minimum increment		0,002
Velocità di rotazione Rotation speed		33,3 Giri/min
Rapporti vite/corona Speed reduction ratio (screw/gear)		1/90
Rapporti vite/motore Speed reduction ratio (screw/motor)		1/180
Precisione Indexing accuracy		±10 Sec.
Ripetibilità Repeatability		4 Sec.
Max. carico di lavoro sul divisore Max. allowable work weight on the dividing head	Verticale Vertical	Kg.550
	Orizzontale Horizontal	Kg.1500
Max. carico di spinta applicabile sul divisore Max. allowable tool load on the dividing head		N 25000
		FxL Nm 1000
		FxL Nm 2200
Rapporti vite/corona Speed reduction ratio (screw/gear)	Verticale Vertical	10,5 Kg. m ²
Coppia in lavoro Driving torque	Corona dentata Worm gear	698 Nm
Kg		110
Cod.		8.DP.G2500

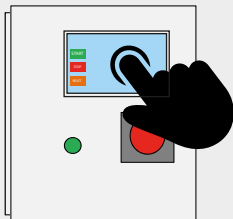

PROGRAMMAZIONE TOUCH SCREEN
FACILE ED INTUITIVA O TRAMITE COLLEGAMENTO DIRETTO AL CNC

EASY AND INTUITIVE TOUCH SCREEN
PROGRAMMING OR THROUGH DIRECT CONNECTION TO THE CNC

- Installazione semplice (alimentazione 220V)
- Corona in bronzo speciale
- Controsupporto semplice
- Vite senza fine in acciaio temprato e rettificato
- Vite e corona in bagno d'olio
- Cuscinetti a vite precaricati
- Cuscinetto anteriore a rulli incrociati sovradimensionato
- Recupero gioco con avvicinamento assiale
- Completa tenuta stagna ai liquidi con possibilità di pressurizzazione
- Possibilità di montare motori di tutte le marche
- Dimensioni esterne contenute
- Finestra di controlli liquidi e condensa
- Lavorazione in posizionamento a 360°

- Easy installation (220V)
- Special bronze crown
- Simple tailstock
- Worm screw in hardened ground steel
- Bath lubrication Screw and Crown
- Pre-loaded screw bearings
- Over-dimensioned crossed-roller front bearing
- Play recover with axial approach
- Watertight seal with possibility of pressurization
- Possibility to mount motors of all brands
- Reduced external dimensions
- Condensation and liquid control window
- 360° work positioning

DPG 250

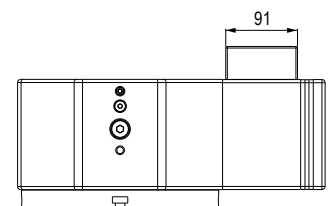
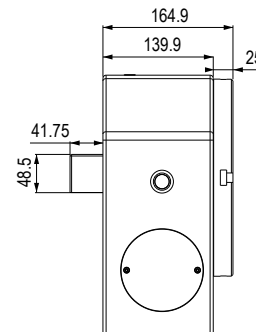
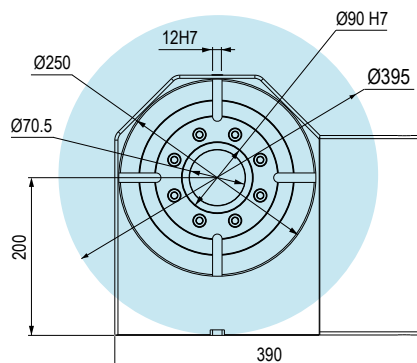

Tipo (grandezza) / Type (size)

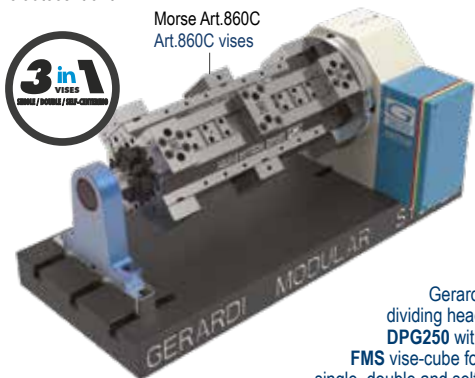
 Divisore Gerardi **DPG250**
 con cubo-morsa **FMS**
 per serraggi singoli, doppi
 o autocentranti

 Morse Art.860C
 Art.860C vises

 Gerardi
 dividing head
DPG250 with
FMS vise-cube for
 single, double and self-
 centering clamping

kN	1		2				3				
	25 kN		25 kN				30 kN				
D	200	300	300	400	500	600	400	500	600	700	800
G1	120		175				210				
W	74		94				124				
Cod.	5.DP.G25000	5.DP.G25010	5.DP.G25020	5.DP.G25030	5.DP.G25040	5.DP.G25050	5.DP.G25060	5.DP.G25070	5.DP.G25080	5.DP.G25090	5.DP.G25011

Nel caso si disponga di un proprio divisore, il prezzo dell'attrezzatura potrebbe subire variazioni
 In case you already have a divider, the price may be revised

UPGRADE YOUR VISE APPLICATIONS THROUGH MODULAR ACCESSORIES !
Art. 99A

 Supporto
 Support

Cod. 5.99.A1000

Art. 99B

 Perno di centraggio completo
 di sistema d'allineamento
 Horizontal centering pin with alignment system

Cod. 5.99.B1000 5.99.B2000 5.99.B3000

Art. 99H

 Distanziale per supporto
 Spacer support



Cod. 5.99.H1000

Art. 62K
DIVIGER 205

 Piastra di interfaccia per cubo FMS
 completa di sistema d'allineamento
 Connecting plate with alignment system for FMS

Cod. 5.62.K801A5 5.62.K801A6 5.62.K801A7

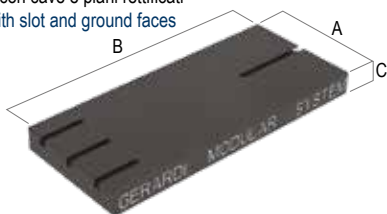
Art. 99S

 Piastra base con cave e piani rettificati
 Base plate with slot and ground faces

Dimensioni B mm Dimension B mm	A	C	Kg	Cod.
650	400	50	102	7.99.S065S
950	400	50	149	7.99.S095S
1250	400	50	195	7.99.S125S

Cave o fori calibrati su richiesta - Slot or calibrated holes on request

Disponibili quote "B" a step di 50mm - Available dimension "B" in steps of 50mm

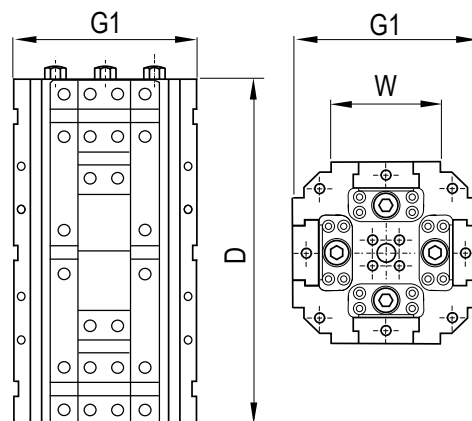
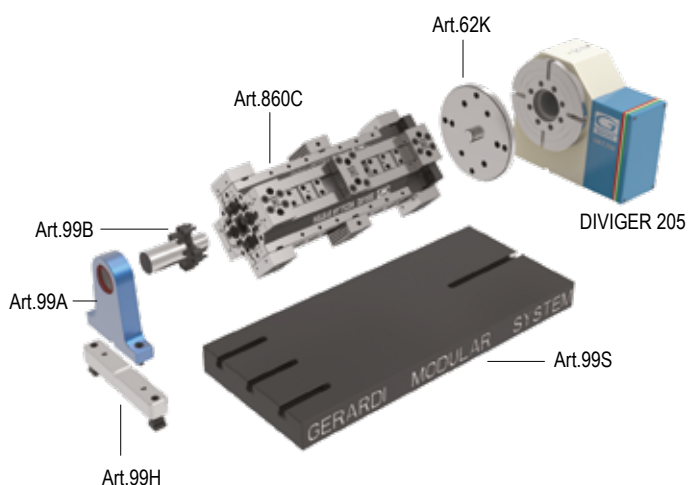

DIVISORE MECCANICO DIVIGER 205

MECHANICAL DIVIDING HEAD DIVIGER 205

Divisore automatico
Automatic dividing head

Dati tecnici
Technical Data

DIVIGER 205



Diametro del divisore Dividing head diameter	220 mm
Diametro del foro passante Clearance hole diameter	85 mm
Altezza centrale Center height	200 mm
Dimensione della scanalatura a T T-Slot width	-
Sistema di bloccaggio Clamping system	Meccanico Mechanical
Minimo incremento Minimum increment	1°
Precisione Indexing accuracy	±10 Sec.
Coppia in lavoro Driving torque	 3000 Nm
Kg	93
Cod.	7.66.73000

DIVISORE MECCANICO, SENZA CAVI O IDRAULICA,
PERMACCHINE A CNC

MECHANICAL DIVIDING HEAD, WITHOUT ELECTRICAL CABLES
OR HYDRAULIC, FOR CNC MILLING MACHINE

- Maggiore efficienza nella lavorazione su più lati
- Completamente autonomo dalla macchina
- Elevato momento torcente
- Divisione manuale o automatica tramite mandrino macchina
- 360 posizioni
- Serraggio simultaneo di due particolari grazie alla doppia flangia
- lavorazione su 5 facce senza contropunta
- Lavorazione a barra grazie al mandrino cavo
- Utilizzabile orizzontalmente o verticalmente
- Cambio tramite serraggio a cuneo
- Cost-effective on multiple-sides machining
- Machine independent
- High holding torque
- Dividing manually or automatically using the machine spindle
- 360 x 1° division
- Simultaneous clamping of 2 workpieces thanks to the dual flange
- 5 faces machining without counter-holder
- Bar machining due to hollow spindle
- To be used horizontally or vertically
- Quick change through wedge clamping

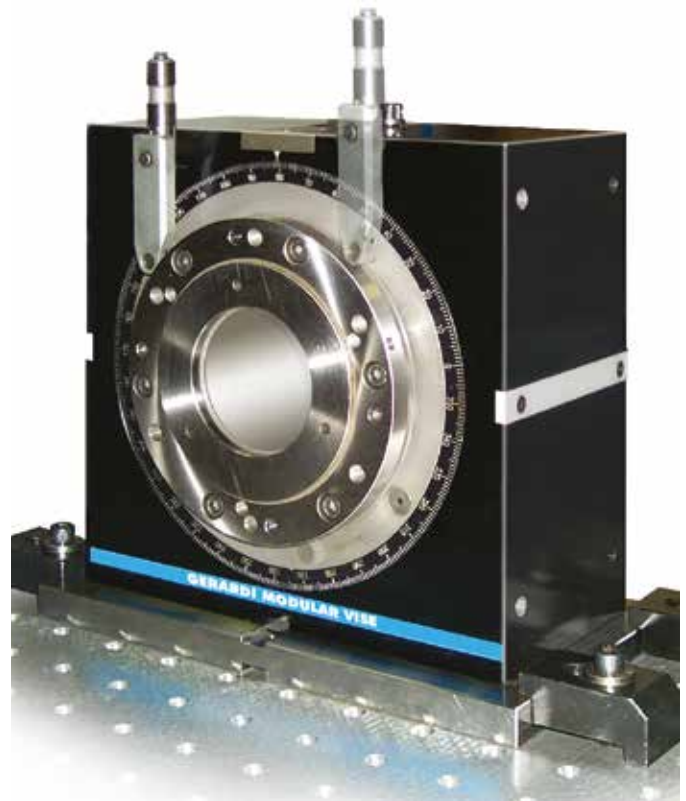

DIVIGER 205

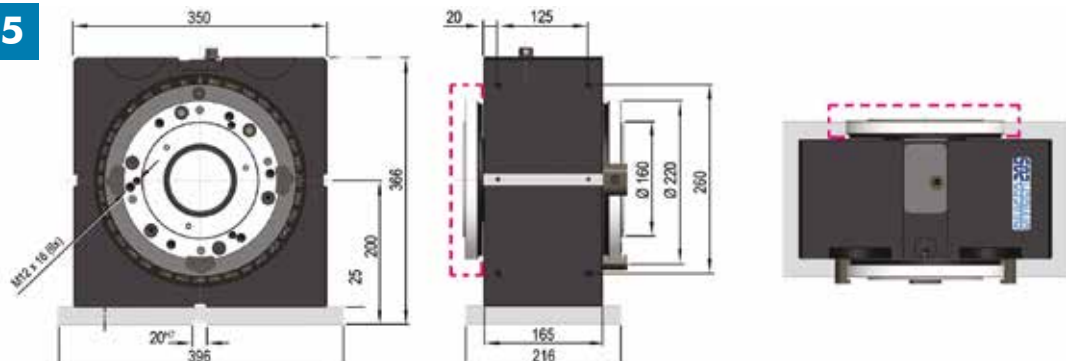

Tipo (grandezza) / Type (size)

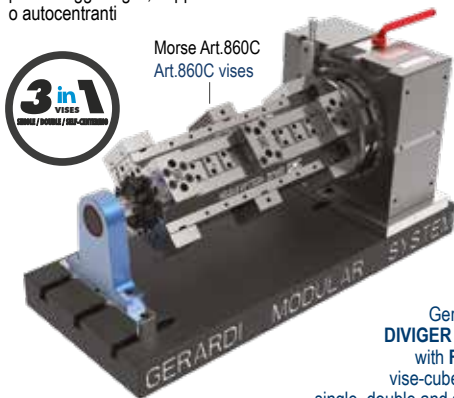
 Divisore Gerardi **DIVIGER 205**
 con cubo-morsa **FMS**
 per serraggi singoli, doppi
 o autocentranti

 Morse Art.860C
 Art.860C vises

 Gerardi
DIVIGER 205
 with **FMS**
 vise-cube for
 single, double and self-
 centering clamping

kN	1		2				3				
	25 kN		25 kN				30 kN				
D	200	300	300	400	500	600	400	500	600	700	800
G1	120		175				210				
W	74		94				124				
Cod.	5.DI.V20500	5.DI.V20510	5.DI.V20520	5.DI.V20530	5.DI.V20540	5.DI.V20550	5.DI.V20560	5.DI.V20570	5.DI.V20580	5.DI.V20590	5.DI.V20511

Nel caso si disponga di un proprio divisore, il prezzo dell'attrezzatura potrebbe subire variazioni
 In case you already have a diviger, the price could be modified

UPGRADE YOUR VISE APPLICATIONS THROUGH MODULAR ACCESSORIES !
Art. 99A

 Supporto
 Support

Cod. 5.99.A1000

Art. 99B

 Perno di centraggio completo
 di sistema d'allineamento
 Horizontal centering pin with alignment system

Cod. 5.99.B1000 5.99.B2000 5.99.B3000

Art. 99H

 Distanziale per supporto
 Spacer support



Cod. 5.99.H1000

Art. 62K
DIVIGER 205

 Piastra di interfaccia per cubo FMS
 completa di sistema d'allineamento
 Connecting plate with alignment system for FMS

Cod. 5.62.K801A5 5.62.K801A6 5.62.K801A7

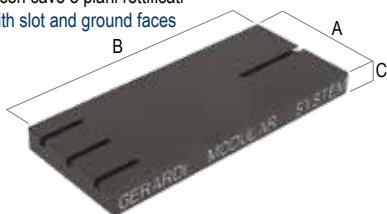
Art. 99S

 Piastra base con cave e piani rettificati
 Base plate with slot and ground faces

Dimensioni B mm Dimension B mm	A	C	Kg	Cod.
650	400	50	102	7.99.S065S
950	400	50	149	7.99.S095S
1250	400	50	195	7.99.S125S

Cave o fori calibrati su richiesta - Slot or calibrated holes on request

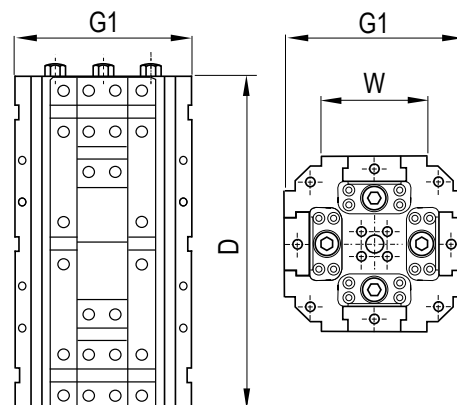
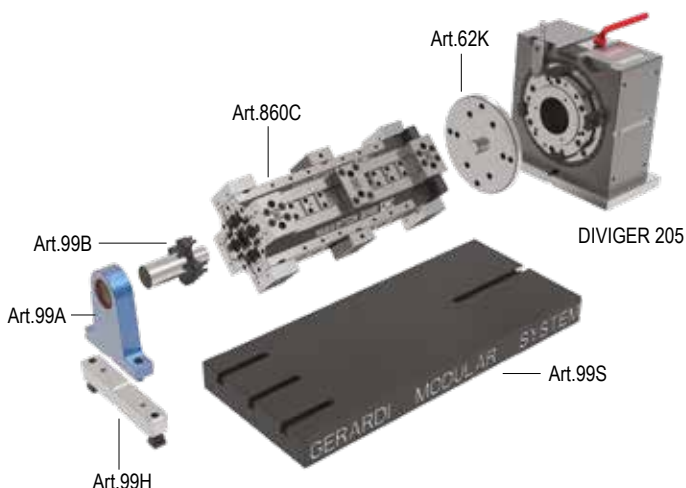

Disponibili quote "B" a step di 50mm - Available dimension "B" in steps of 50mm



PREDISPOSIZIONE e MONTAGGIO MORSE su CUBI LAVORATI

TOMBSTONES SET-UP and VISES MOUNTING on MACHINED TOMBSTONES

5

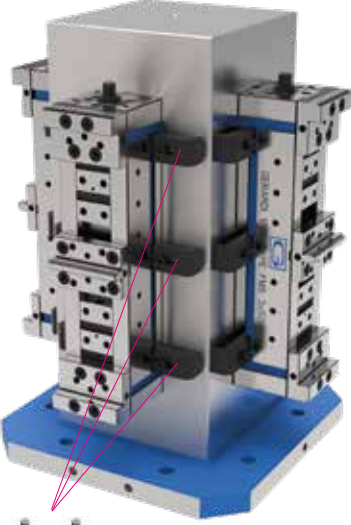



Cubo lavorato Art.57C Machined cube Art.57C	Tipo di morsa Vise type	Predisposizione e montaggio* Set-up & Mounting*	Cubo con morse Cube with vises
Cod. 8.53.C00081 Dim. A=250 / B=400 / H=660 	Art.864 Tipo 3x500  n°morse Vises n° x 4	Per morsa / each vise  Importo per lavorazioni necessarie per predisporre ogni faccia del cubo e montaggio più allineamento di ogni morsa. Amount needed for the set-up of each side and mounting + alignment of each vise on it.	 Art.296 Certificato di collaudo Certificate test

* Predisposizione facce cubo, montaggio ed allineamento morse incluso di viti, chiavette, staffe e quant'altro necessario.
 Faces set-up, vises mounting including screws, keyways, holding clamps and all the necessary equipment.

Certificato di collaudo
 Certificate test

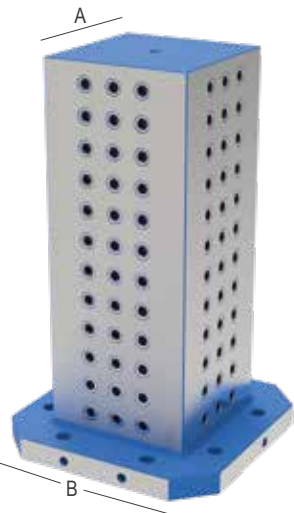
PREDISPOSIZIONE e MONTAGGIO MORSE su CUBO a RETICOLO

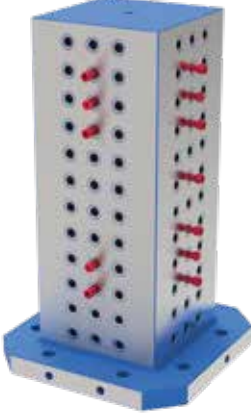
TOMBSTONES SET-UP and VISES MOUNTING on 2 GRID TOMBSTONES

Cubo a reticolo Art.53F Grid tombstone Art.53F	Tipo di morsa Vise type	Montaggio e allineamento* Mounting & alignment*	Cubo con morse Cube with vises
Cod. 8.53.F00081 Dim. A=250 / B=400 / H=660 	Art.864 Tipo 3x500  n°morse Vises n° x 4	Per morsa / each vise  Importo per montaggio ed allineamento di ogni morsa. Amount need for each vise mounting and alignment.	Art.750 Tipo 3  Art.83 Certificato di collaudo Certificate test

* Montaggio e allineamento morse incluso di viti, chiavette, staffe e quant'altro necessario.
 Vises mounting and alignment includes screws, keyways, holding clamps and all the necessary equipment.

Certificato di collaudo
 Certificate test

DISPOSITIVO TERZA MANO PER MORSE FMS DOPPIE

THIRD HAND ACCESSORY FOR DOUBLE FMS VISES

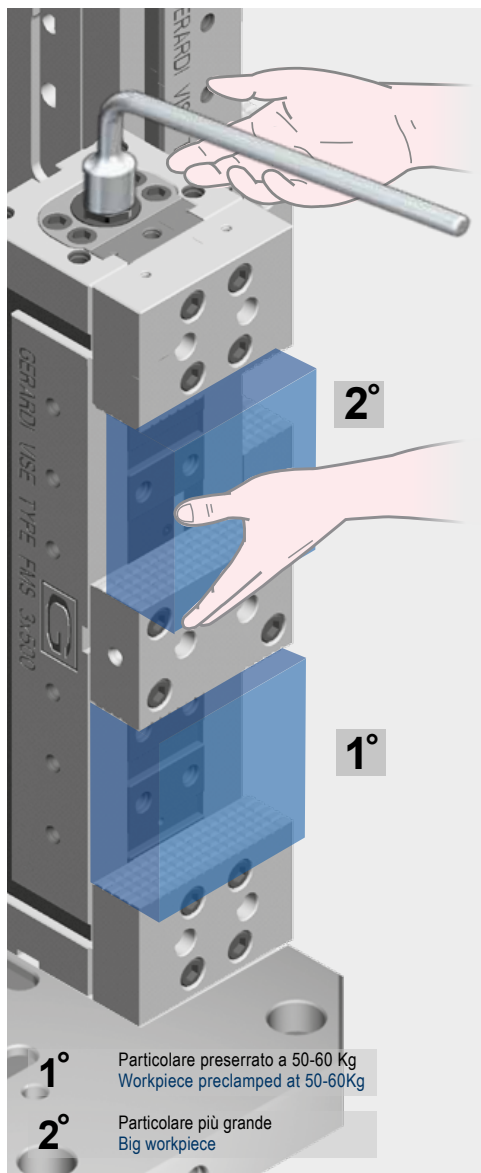

1° Particolare preserrato a 50-60 Kg
Workpiece preclamped at 50-60Kg

2° Particolare più grande
Big workpiece

DISPOSITIVO TERZA MANO PER MORSE FMS DOPPIE

Il meccanismo "Terza mano" nella morsa in versione a doppia stazione, consente il carico e serraggio lieve del primo pezzo (dalla parte opposta alla chiave nella stazione inferiore della morsa), mentre nel frattempo viene caricato il secondo pezzo di dimensione maggiore (da cui la denominazione "Terza mano"). Tale dispositivo risulta particolarmente utile quando la morsa viene usata in posizione verticale. Con il dispositivo "Terza mano", i due particolari da lavorare possono essere di dimensioni diverse con uno scarto massimo fra loro di 2 mm.

Il meccanismo "Terza mano" standard ha una spinta di max 50 Kg. Volendo ottenere una spinta maggiore, basta sostituire le molle in dotazione con altre di maggior potenza (attenzione però a mantenere la stessa quota di altezza del pacchetto molle) oppure aggiungendo un altro distanziale di max. 3mm

N.B: sostituendo le molle o aggiungendo un distanziale extra bisogna tener presente che il maggior precarico comporterà lo stesso carico di spinta anche girando la vite Art.822 a vuoto.

Non volendo il meccanismo "Terza Mano", il tutto può essere semplicemente rimosso togliendo le molle con i relativi distanziali dalla loro sede naturale.

Attenzione!! Assicurarsi che Art.850N rimanga fissato nella morsa per proteggere l'eventuale entrata di trucioli.

THIRD HAND DEVICE FOR DOUBLE STATION FMS VISES

The "Third Hand" device in the double station vise configuration, allows the first workpiece loaded to be gripped/clamped lightly with a little pressure (on the opposite side of the wrench and then in the lower vise station), while the second workpiece (bigger than first) is being loaded (from here the "third Hand" denomination). Such device is useful especially with the vise vertically positioned.

With the "Third Hand" device the two workpiece can be up to 2 mm different in gripping width.

The standard "Third Hand" device has a max pressure of 50 Kg.

In order to reach a higher clamping power it is enough to preload by changing the standard springs with more powerful ones or by adding a spacer (max 3 mm). Be careful that remains the same spring and spacer packing height dimensions.

P.S: By changing springs or adding extra spacer remember that the higher preload will give the same resistance (given by the more powerful preload) even just turning the main screw Art.822 freely.

If the "Third Hand" device is not required, it could be simply removed by taking away the springs and their spacers from their standard position.

Attention!! Make sure that the Art.850N remains fixed in the vise to provide protection from dirt getting inside the vise.

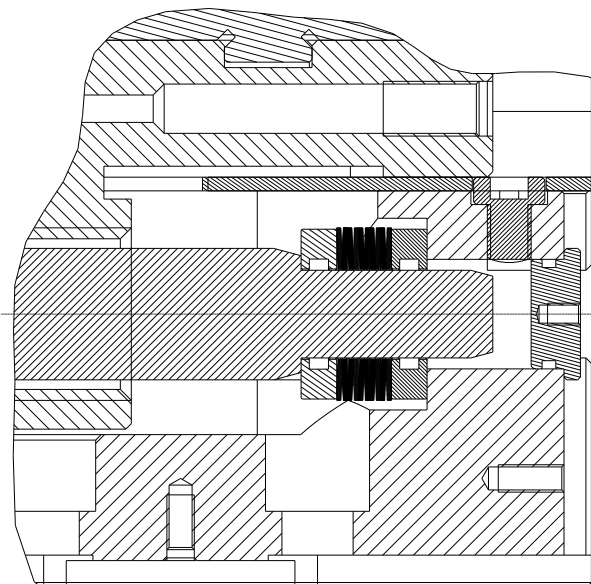

Art.850P



Diagrammi di serraggio / Clamping diagrams

FMS

Diagrammi di serraggio meccanico con chiave dinamometrica

Mechanical clamping diagrams with torque wrench

Art. 357

Morse tipo Vises type

1

VITE: TPF 18 / 20 mm PASSO: 2 mm
SCREW: TPF 18 / 20 mm PITCH: 2 mm

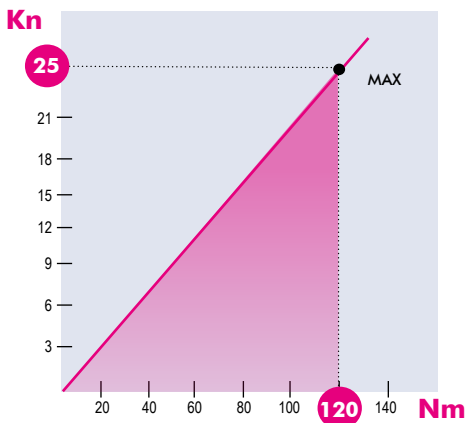

Art. 357

Morse tipo Vises type

2

VITE: TPF 18 / 24 mm PASSO: 2 mm
SCREW: TPF 18 / 24 mm PITCH: 2 mm

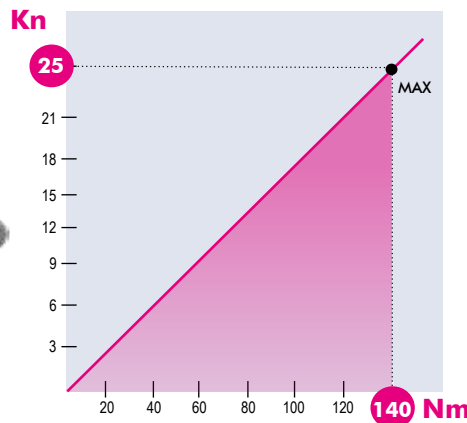

5

Morse tipo Vises type

3-4

VITE: TPF 24 / 30 mm PASSO: 2 mm
SCREW: TPF 24 / 30 mm PITCH: 2 mm

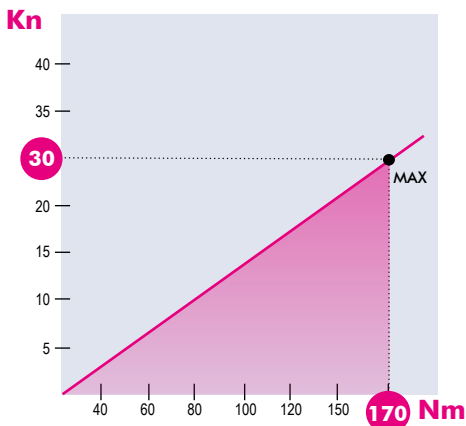

Art. 357

Morse tipo Vises type

5-6

VITE: TPF 30 / 36 mm PASSO: 3 mm
SCREW: TPF 30 / 36 mm PITCH: 3 mm

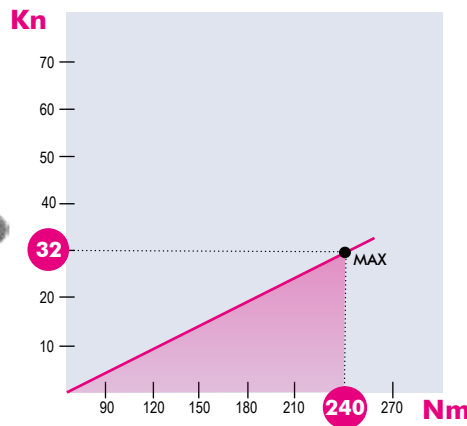

NB: Alcuni fattori, come la lubrificazione, lo staffaggio, gli attriti ed altro, possono modificare i valori indicati fino a $\pm 10\%$. Per un corretto utilizzo non superare i valori indicati nel grafico
Some factor as lubrication, clamping on the machine table, frictions and more can modify above values within a $\pm 10\%$ range. For optimum operation do not exceed chart values.

Diagrammi serraggio / Clamping diagrams

FMS

Diagrammi di serraggio meccanico con moltiplicatore di potenza

Mechanical clamping diagrams with pressure multiplier

Art. 802

Morse tipo Vises type

1

 VITE: TPF 18 / 20 mm PASSO: 2 mm
 SCREW: TPF 18 / 20 mm PITCH: 2 mm
 Rapporto trasmissione: 1/9
 Gear ratio: 1/9

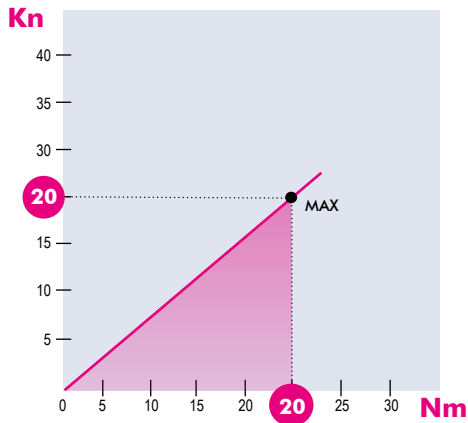
Type 1 Cod. 5.80.21000

Art. 802

Morse tipo Vises type

2

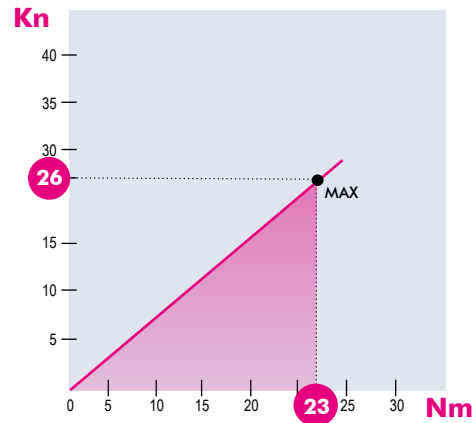
 VITE: TPF 18 / 24 mm PASSO: 2 mm
 SCREW: TPF 18 / 24 mm PITCH: 2 mm
 Rapporto trasmissione: 1/7
 Gear ratio: 1/7

Type 2 Cod. 5.80.22000

5

Morse tipo Vises type

3-4

 VITE: TPF 24 / 30 mm PASSO: 2 mm
 SCREW: TPF 24 / 30 mm PITCH: 2 mm
 Rapporto trasmissione: 1/7
 Gear ratio: 1/7

Type 3

Cod. 5.80.23000

Type 4

Cod. 5.80.24000

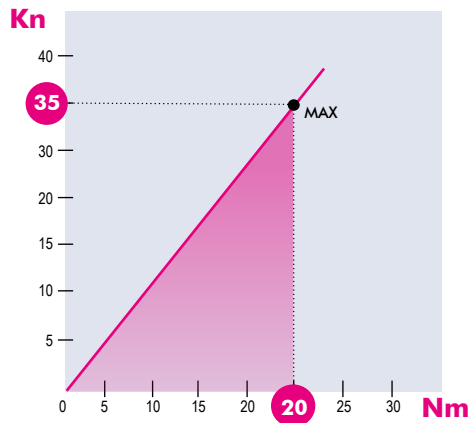
Art. 802

Morse tipo Vises type

5-6

 VITE: TPF 30 / 36 mm PASSO: 3 mm
 SCREW: TPF 30 / 36 mm PITCH: 3 mm
 Rapporto trasmissione: 1/7
 Gear ratio: 1/7

Type 5

Cod. 5.80.25000

Type 6

Cod. 5.80.26000

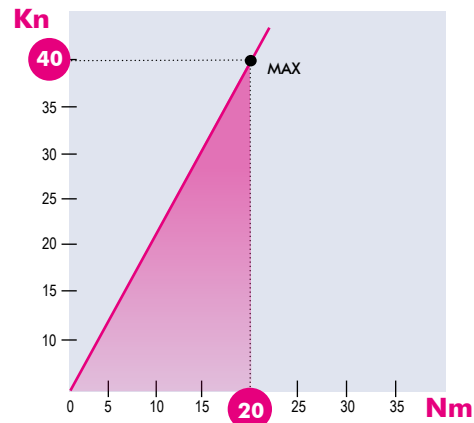

NB: Alcuni fattori, come la lubrificazione, lo staffaggio, gli attriti ed altro, possono modificare i valori indicati fino a $\pm 10\%$. Per un corretto utilizzo non superare i valori indicati nel grafico
 Some factor as lubrication, clamping on the machine table, frictions and more can modify above values within a $\pm 10\%$ range. For optimum operation do not exceed chart values.

Diagrammi serraggio / Clamping diagrams

FMS

Diagrammi di serraggio meccanico tramite motore idraulico

Mechanical clamping diagrams through hydraulic motor **Art. 890**

Morse tipo Vises type

1

VITE: TPF 18 / 20 mm PASSO: 2 mm
 SCREW: TPF 18 / 20 mm PITCH: 2 mm
 Motore idraulico tipo **OMM 32**
 Hydraulic motor type **OMM 32**

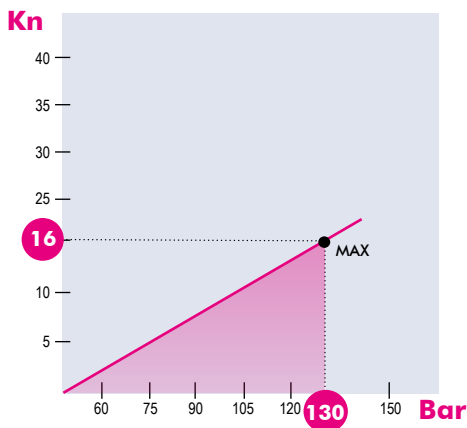

Art. 890

Morse tipo Vises type

2

VITE: TPF 18 / 24 mm PASSO: 2 mm
 SCREW: TPF 18 / 24 mm PITCH: 2 mm
 Motore idraulico tipo **OMP 80**
 Hydraulic motor type **OMP 80**

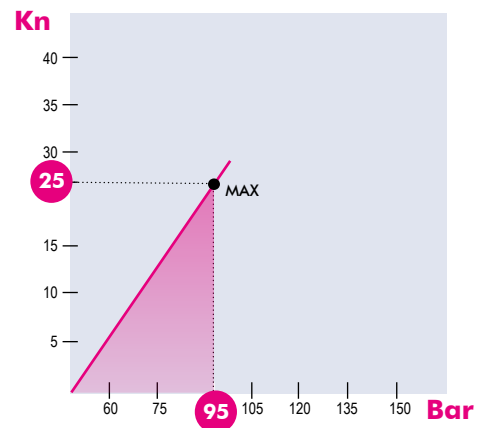

Morse tipo Vises type

3-4

VITE: TPF 24 / 30 mm PASSO: 2 mm
 SCREW: TPF 24 / 30 mm PITCH: 2 mm
 Motore idraulico tipo **OMR 200**
 Hydraulic motor type **OMR 200**

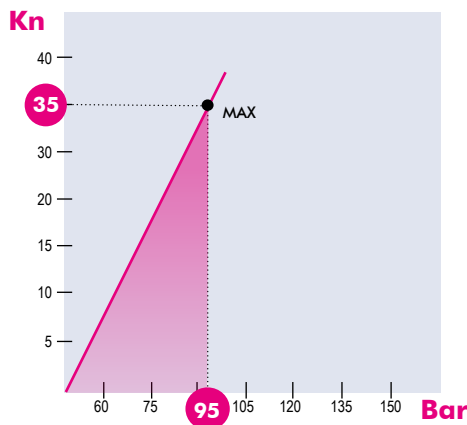

Art. 890

Morse tipo Vises type

5-6

VITE: TPF 30 / 36 mm PASSO: 3 mm
 SCREW: TPF 30 / 36 mm PITCH: 3 mm
 Motore idraulico tipo **OMR 200**
 Hydraulic motor type **OMR 200**

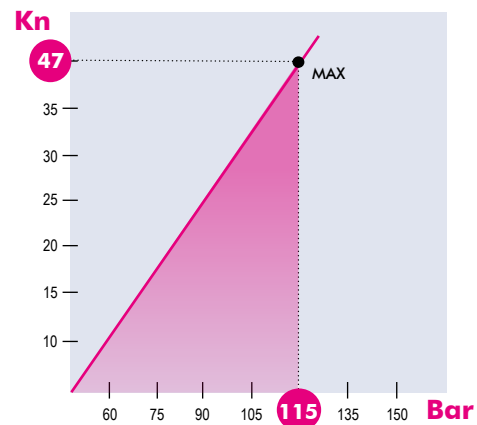

ATTENZIONE! Azionamento idraulico ma serraggio meccanico (PIU' SICURO) - IMPORTANT! Hydraulic control, but mechanical clamping (SAFER)

NB: Alcuni fattori, come la lubrificazione, lo staffaggio, gli attriti ed altro, possono modificare i valori indicati fino a $\pm 10\%$. Per un corretto utilizzo non superare i valori indicati nel grafico
 Some factor as lubrication, clamping on the machine table, frictions and more can modify above values within a $\pm 10\%$ range. For optimum operation do not exceed chart values.

ISTRUZIONI PER UN CORRETTO UTILIZZO

INSTRUCTIONS FOR A PROPER USE



Libretto Istruzioni / Instruction Book

Scansiona il QR code e scarica le istruzioni complete

Scan the QR code to download the complete instructions

TOLLERANZE GEOMETRICHE

GEOMETRIC ACCURACIES

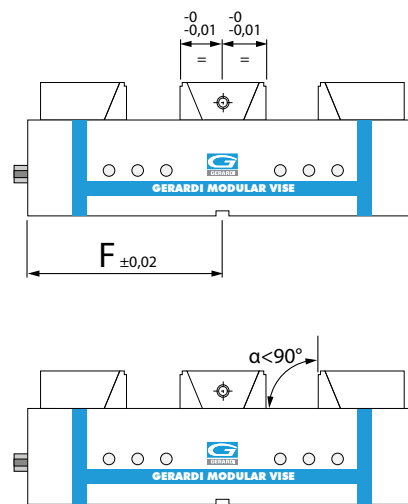
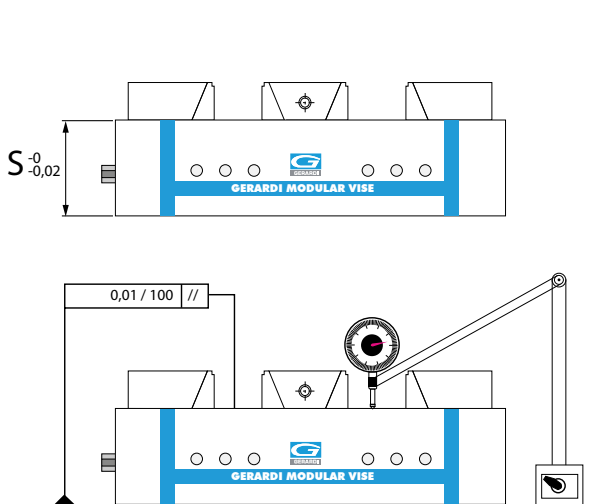

TOLLERANZE DINAMICHE

DINAMIC ACCURACIES

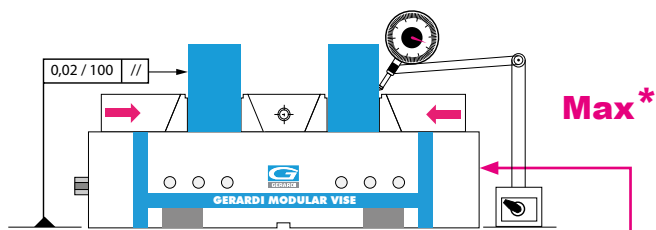

Morsa ancorata con 2 coppie di staffe Art.296
Vise clamped with n. 2 pairs of Art.296

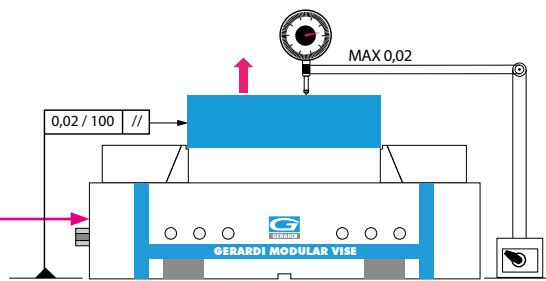

Morsa ancorata con 2 coppie di staffe Art.296
Vise clamped with n. 2 pairs of Art.296

Art 865	* Coppia applicata - Torque Nm	Forza di serraggio - Clamping power
Morsa tipo 1 Vise type 1	120	2500 Kgf
Morsa tipo 2 Vise type 2	140	2500 Kgf
Morsa tipo 3 Vise type 3	180	3000 Kgf
Morsa tipo 4 Vise type 4	180	3000 Kgf
Morsa tipo 5 Vise type 5	240	3200 Kgf
Morsa tipo 6 Vise type 6	240	3200 Kgf

* Max coppia applicabile per non superare i valori consigliati

1 kgf . m = 9.806

ESTREMA VERSATILITY
EXTREME VERSATILITY

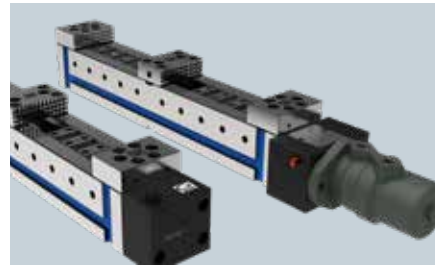

Sistema di serraggio meccanico, idraulico, pneumatico elettrico o con moltiplicatore di potenza, tramite comando manuale, a pedale o mediante pulsante elettrico (vedi pag. 12)

Mechanic, hydraulic or pneumatic or electrical clamping system or with pressure multiplier, through manual, pedal or push button control (see page 12)

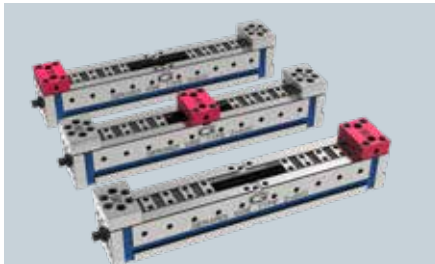

3 posizioni per la ganaschia fissa
3 positions for the fixed jaw

Costruzione solida e compatta e massima apertura rispetto alla sua lunghezza

Space saving design, solid construction and maximum blocking ratio to total length

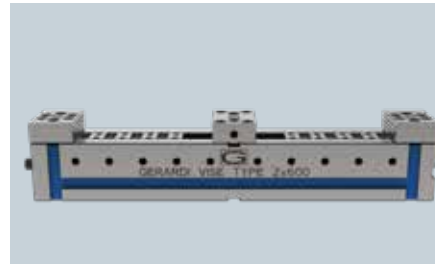

Serraggio dall'esterno all'interno e viceversa
Outside to inside clamping and viceversa

Precisioni geometriche con tolleranze entro 0,02mm

Geometrical accuracy with tolerances within 0,02 mm

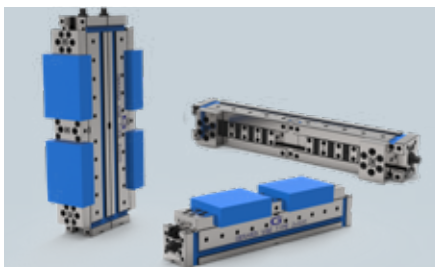
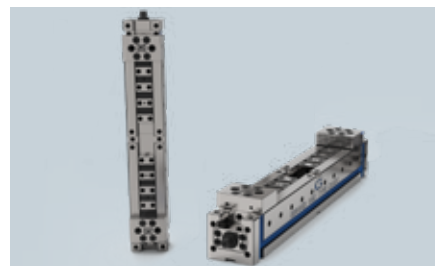

Posizionamento verticale-orizzontale laterale grazie alle chiavette longitudinali e trasversali sia sulla base che in testa
Vertically, horizontally and sideway vise positioning by the

Accurata ripetibilità di posizionamento dei particolari da lavorare

Very accurate repetibility of workpieces position

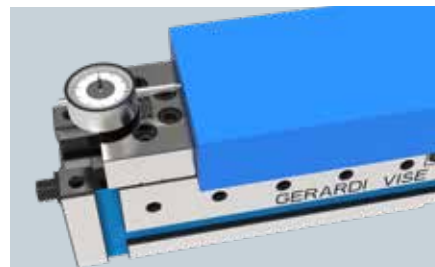

Collegamento: fianco a fianco, dorso a dorso
Side by side, back to back vise positioning

Flessioni ridotte di due volte rispetto alle morse modulari STANDARD

Bending reduced two times with respect to the STANDARD modular vises

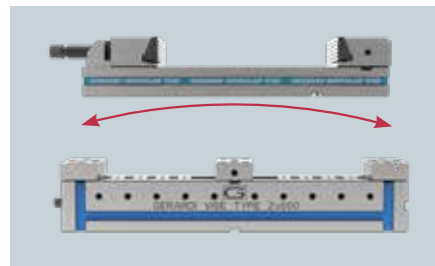

Possibilità illimitata per ganasce speciali
Unlimited range of special jaws

Trasformazione da autocentrante a doppia tramite la sostituzione delle ganasce sul corpo base universale e tramite la ghiera di regolazione.

Transform each single vise in a self-centering with possibility to block from outside to inside and vice versa and in a double vise through the substitution of the jaws on the universal vise body base and by the setting nut.

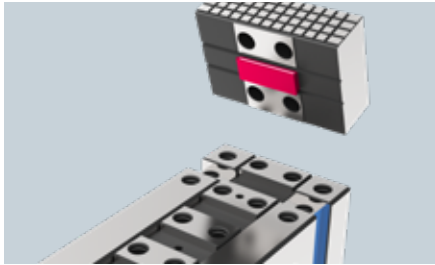
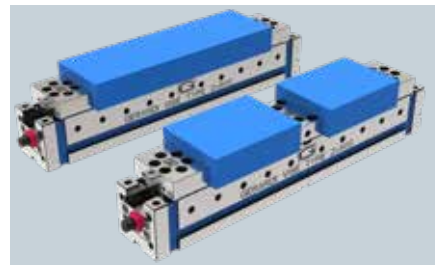

Sostituzione semplice e precisa delle ganasce
Simple and precise exchange of jaws

Protezione integrale dalla penetrazione di corpi estranei tramite piastre scorrevoli

Integral protection from chips and dirty through sliding protections

